

# JVC

## SCHEMATIC DIAGRAMS

VHS & HDD & DVD VIDEO RECORDER

### DR-MX10SE, DR-MX10SEF, DR-MX10SEK

CD-ROM No.SML200601

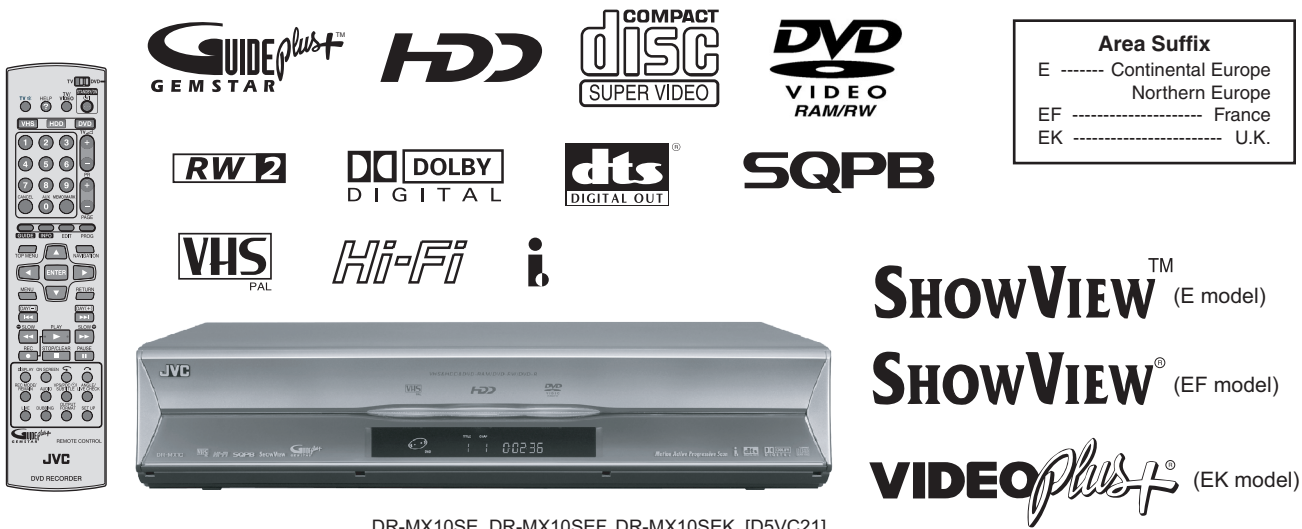

DR-MX10SE, DR-MX10SEF, DR-MX10SEK [D5VC21]

\*Since the whole mechanism assembly unit is replaced, the DVD recorder mechanism of this unit need not be adjusted.

\*For disassembling and assembling of VHS MECHANISM ASSEMBLY, refer to the SERVICE MANUAL No.86700 (MECHANISM ASSEMBLY).



# CHARTS AND DIAGRAMS

## NOTES OF SCHEMATIC DIAGRAM

### Safety precautions

The Components identified by the symbol  are critical for safety. For continued safety, replace safety critical components only with manufacturer's recommended parts.

### 1. Units of components on the schematic diagram

Unless otherwise specified.

- All resistance values are in ohm. 1/6 W, 1/8 W (refer to parts list).  
Chip resistors are 1/16 W.  
K: KΩ(1000Ω), M: MΩ (1000KΩ)
- All capacitance values are in μF, (P: PF).
- All inductance values are in μH, (m: mH).
- All diodes are 1SS133, MA165 or 1N4148M (refer to parts list).

**Note:** The Parts Number, value and rated voltage etc. in the Schematic Diagram are for references only. When replacing the parts, refer to the Parts List.

### 2. Indications of control voltage

AUX : Active at high.

$\overline{\text{AUX}}$  or AUX(L) : Active at low.

### 3. Interpreting Connector indications

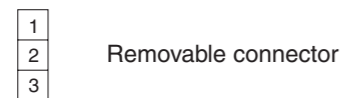

Removable connector

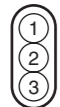

Wire soldered directly on board

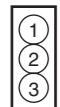

Non-removable Board connector

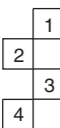

Board to Board

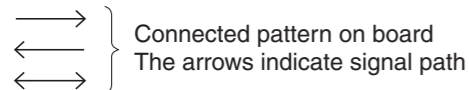

**Note:** For the destination of each signal and further line connections that are cut off from the diagram, refer to "BOARD INTERCONNECTIONS"

### 4. Voltage measurement

- Regulator (DC/DC CONV) circuits  
REC : Colour bar signal.  
PB : Alignment tape (Colour bar).  
— : Unmeasurable or unnecessary to measure.
- Indication on schematic diagram  
Voltage indications for REC and PB mode on the schematic diagram are as shown below.

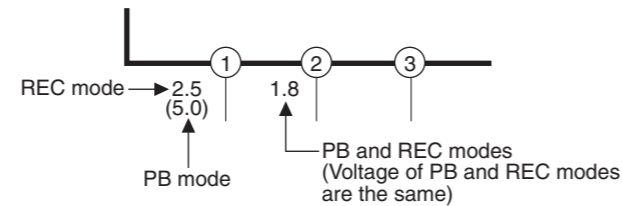





**Note:** If the voltages are not indicated on the schematic diagram, refer to the voltage charts.



### 5. Signal path Symbols

The arrows indicate the signal path as follows.

**NOTE :** The arrow is DVC unique object.

-  Playback signal path
-  Playback and recording signal path
-  Recording signal path (including E-E signal path)
-  Capstan servo path
-  Drum servo path

(Example)

-  Playback R-Y signal path
-  Recording Y signal path

### 6. Indication of the parts for adjustments

The parts for the adjustments are surrounded with the circle as shown below.



### 7. Indication of the parts not mounted on the circuit board

"OPEN" is indicated by the parts not mounted on the circuit board.

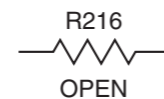

## CIRCUIT BOARD NOTES

### 1. Foil and Component sides

- Foil side (B side) :  
Parts on the foil side seen from foil face (pattern face) are indicated.
- Component side (A side) :  
Parts on the component side seen from component face (parts face) indicated.

Parts location are indicated by guide scale on the circuit board.

### 2. Parts location guides

Parts location are indicated by guide scale on the circuit board.

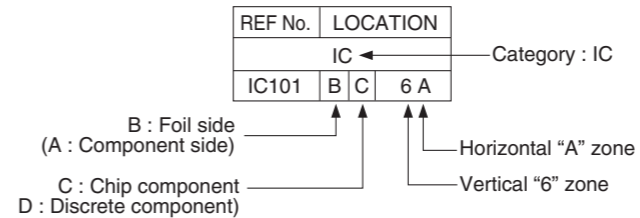

**Note:** For general information in service manual, please refer to the Service Manual of GENERAL INFORMATION Edition 4 No. 82054D (January 1994).

# BOARD INTERCONNECTIONS

5

4

3

2

1

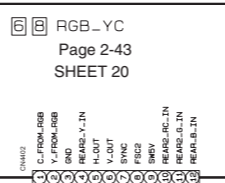
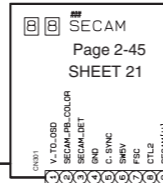
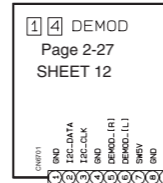
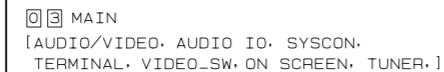
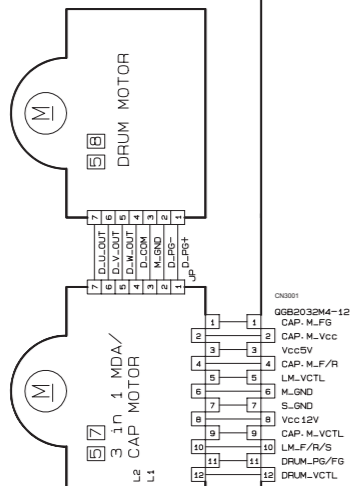

9	2	JUNCTION
8	8	SECAM
6	8	RGB_YC
5	8	DRUM MOTOR
5	7	3 in 1 MDA/CAP MOTOR
5	5	LOADING MOTOR
3	6	DV JACK
2	8	DISP/SW
2	7	OPR/JACK
1	4	DEMOD
1	2	A/C HEAD
1	1	DD CONV.
0	6	TERMINAL
0	3	MAIN
0	2	DIGITAL
0	1	SW REGULATOR
NO		NAME

# OPTION			
	04	03	02
	CN5301	CN7111	CN7107
	MX10 SE/SEK/SEF	1-15pin	1-13pin
			7-19pin

## CN901 IS USED FOR FLASH CRU  
### SECAM IS USED FOR SEF ONLY

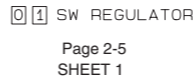

VIDEO/AUDIO ON SCREEN VIDEO SW FMA AUDIO I/O SYSCON TUNER TERMINAL

Page 2-7 SHEET 2  
Page 2-9 SHEET 3  
Page 2-11 SHEET 4  
Page 2-13 SHEET 5  
Page 2-15 SHEET 6  
Page 2-17 SHEET 7  
Page 2-19 SHEET 8  
Page 2-21 SHEET 9

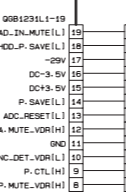
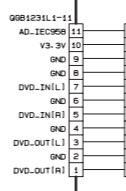
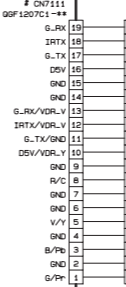
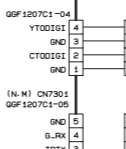
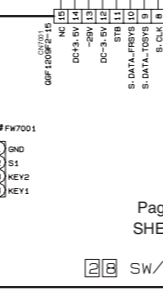
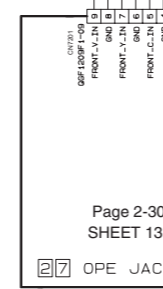

VIDEO IF Page 2-31 SHEET 14  
FLASH Page 2-33 SHEET 15  
MEDIA PROCESSOR Page 2-35 SHEET 16  
DDR SDRAM Page 2-37 SHEET 17  
1394PHY Page 2-39 SHEET 18  
ATAPI IF Page 2-41 SHEET 19

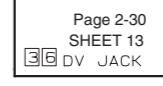

DVD-DRIVE  
HDD

DVD-DRIVE  
HDD

DVD-DRIVE  
HDD

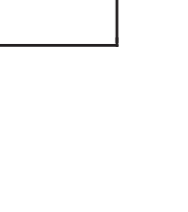
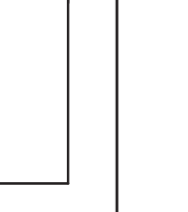
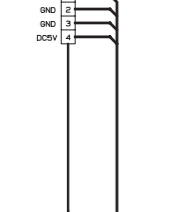
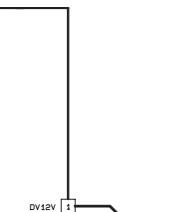
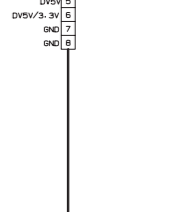
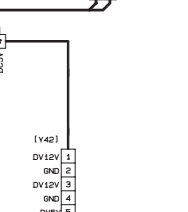
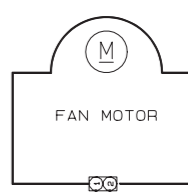



# MAIN(VIDEO/N.AUDIO) SCHEMATIC DIAGRAM

5  
4  
3  
2  
1

03 MAIN(VIDEO/N.AUDIO)

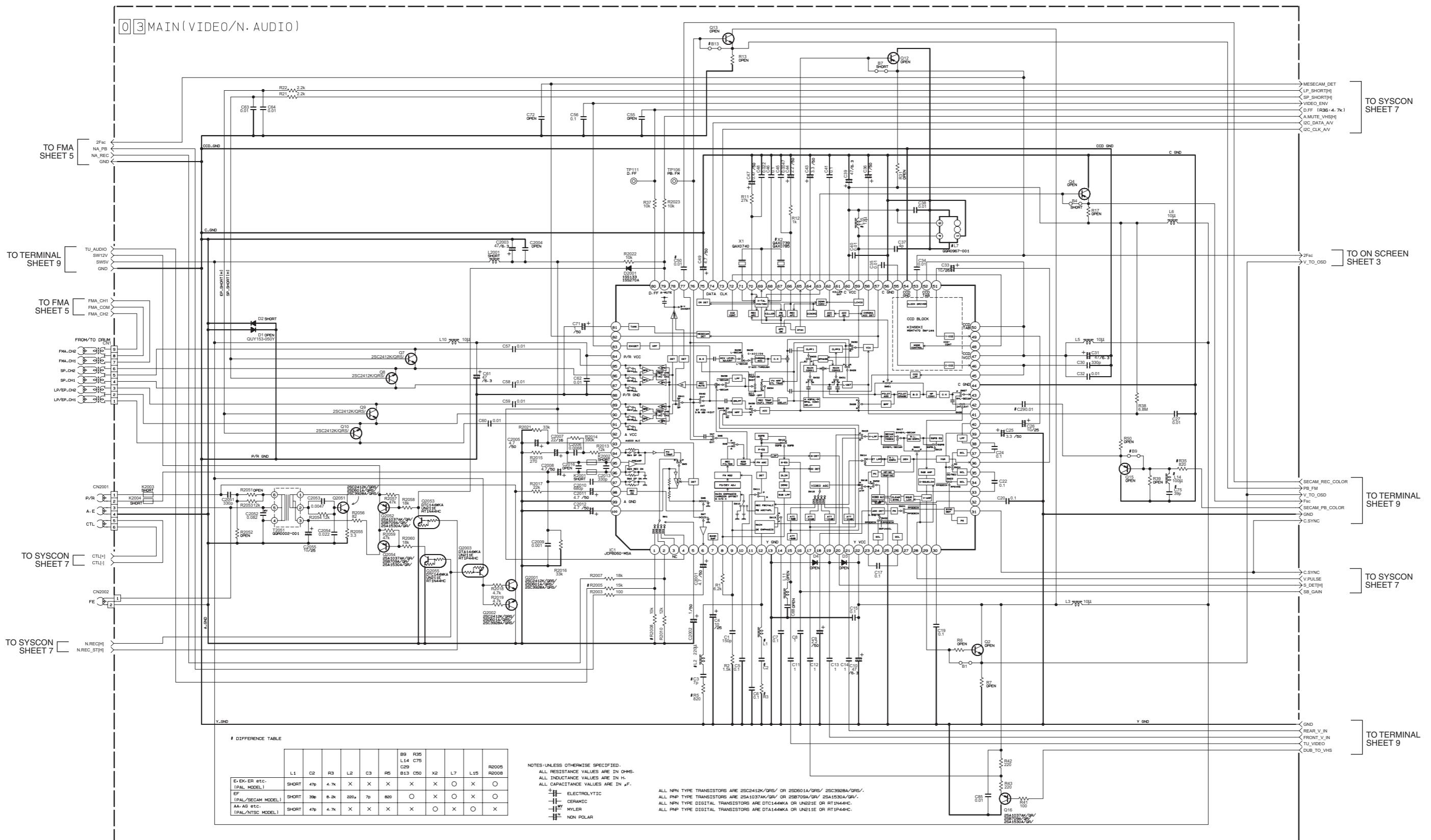

# DIFFERENCE TABLE

	L1	C2	R3	L2	C3	R5	B9	R35	L14	C75	C29	B13	C50	X2	L7	L15	R2005	R2008	
E, EK, ER etc. (PAL MODEL)	SHORT	47k	4.7k	X	X	X	X	X	X	X	X	X	X	X	X	X	X	X	X
EF (PAL/SECAM MODEL)	SHORT	39k	8.2k	220k	7k	820	0	X	0	X	0	X	0	X	0	X	0	0	0
AA, AG etc. (PAL/NTSC MODEL)	SHORT	47k	4.7k	X	X	X	X	X	X	X	X	X	X	X	X	X	X	X	X

NOTES-UNLESS OTHERWISE SPECIFIED:  
ALL RESISTANCE VALUES ARE IN OHMS.  
ALL INDUCTANCE VALUES ARE IN H.  
ALL CAPACITANCE VALUES ARE IN μF.

ELECTROLYTIC  
 CERAMIC  
 MYLAR  
 NON POLAR

ALL NPN TYPE TRANSISTORS ARE 2SC2412K/GRS/ OR 2SD601A/GRS/ 2SC3928A/GRS/  
ALL PNP TYPE TRANSISTORS ARE 2SA1037AK/GRV/ OR 2SB709A/GRV/ 2SA1530A/GRV/  
ALL NPN TYPE DIGITAL TRANSISTORS ARE DT1C14AKA OR UN21E OR RT1P4HC.  
ALL PNP TYPE DIGITAL TRANSISTORS ARE DT1A14AKA OR UN21E OR RT1P4HC.

A B C D E F G

MAIN(ON SCREEN) SCHEMATIC DIAGRAM

03 MAIN (ON SCREEN)

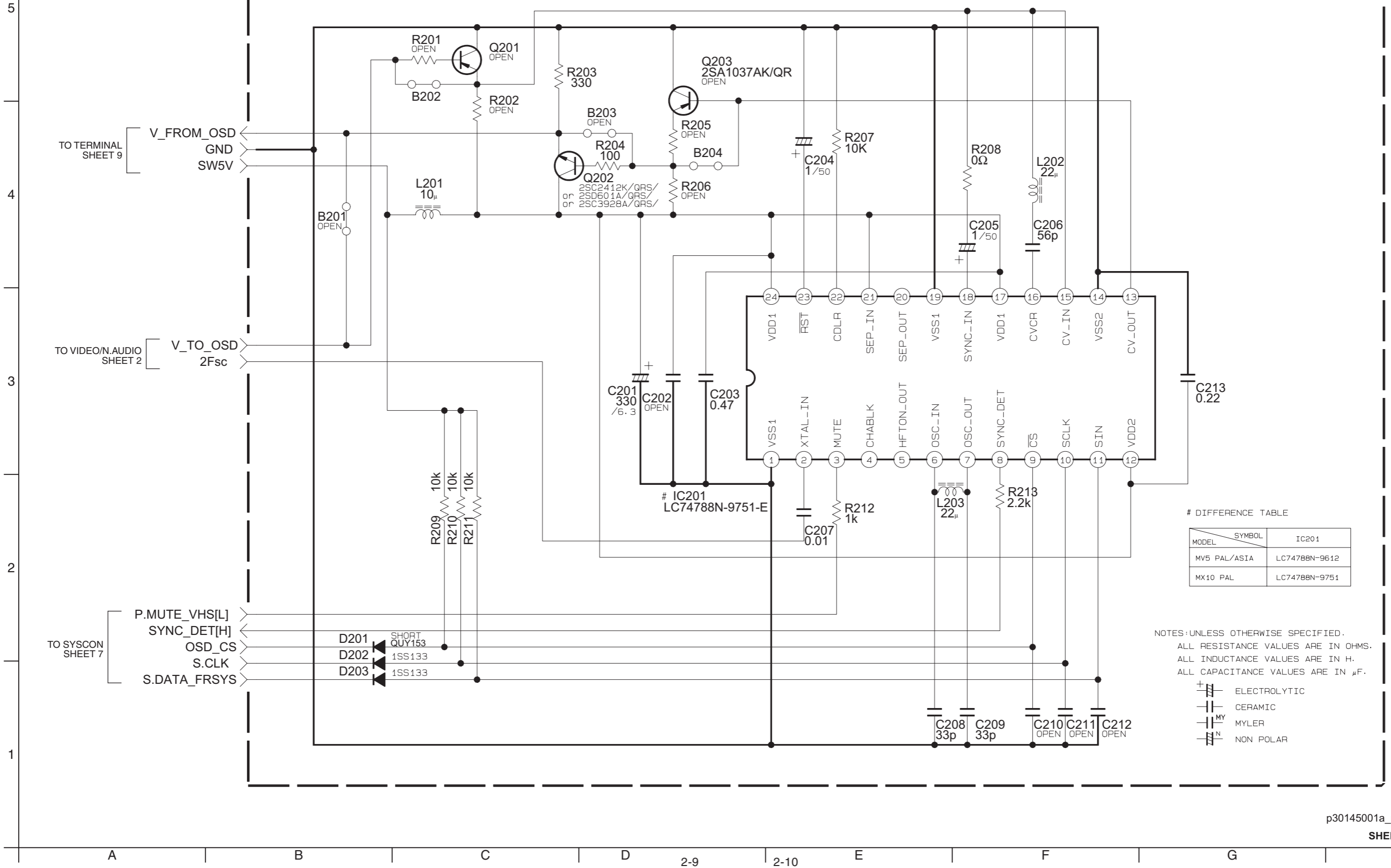

MAIN(VIDEO SW) SCHEMATIC DIAGRAM

0 3 MAIN(VIDEO SW)

# DIFFERENCE TABLE

	R520	R521	C503 C505 C514 C517 C526	R502 R505 R508 R509	B503	B504	## MARK	### MARK
MVS E-EK-EP-EF MODEL	1-Bk	1k				X		X
MX10 E-EK-EP MODEL	X	0a				X		X
MX10 EF MODEL	X	0a				X		X
MVS ASIA MODEL	1-Bk	1k	X	X			X	X

NOTES UNLESS OTHERWISE SPECIFIED:  
 ALL RESISTANCE VALUES ARE IN OHMS.  
 ALL INDUCTANCE VALUES ARE IN H.  
 ALL CAPACITANCE VALUES ARE IN  $\mu$ F.

ELECTROLYTIC  
 CERAMIC  
 MYLAR  
 NON POLAR

ALL NPN TYPE TRANSISTORS ARE 2SC2412K/GRS/ OR 2SD601A/GRS/ 2SC928A/GRS/.  
 ALL PNP TYPE TRANSISTORS ARE 2SA1037AK/GR/ OR 2SB709A/GR/ 2SA1530A/GR/.  
 ALL NPN TYPE DIGITAL TRANSISTORS ARE DTC144WA OR UN221E OR RT1N44C.  
 ALL PNP TYPE DIGITAL TRANSISTORS ARE DT144WA OR UN211E OR RT1P44C.

INPUT	V	Y/C
1	FRONT	FRONT
2	VHS	RGB_Y/C [EU]
3	REAR1 [EU]	REAR1 [EU]
4	REAR1	REAR1
5	TUNER	X

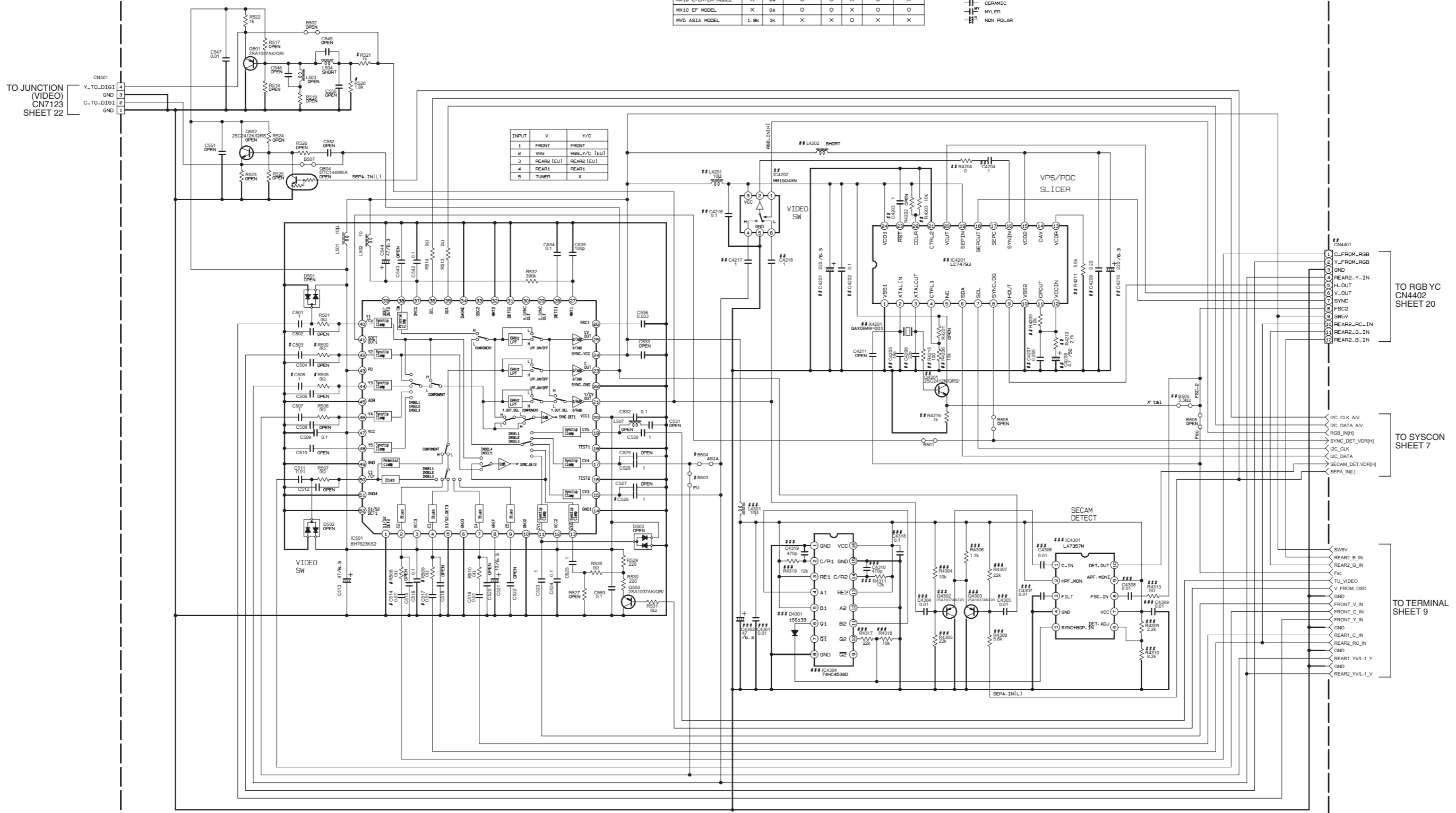

TO RGB YC  
 CN4402  
 SHEET 20

TO SYSCON  
 SHEET 7

TO TERMINAL  
 SHEET 9



# MAIN(FMA) SCHEMATIC DIAGRAM

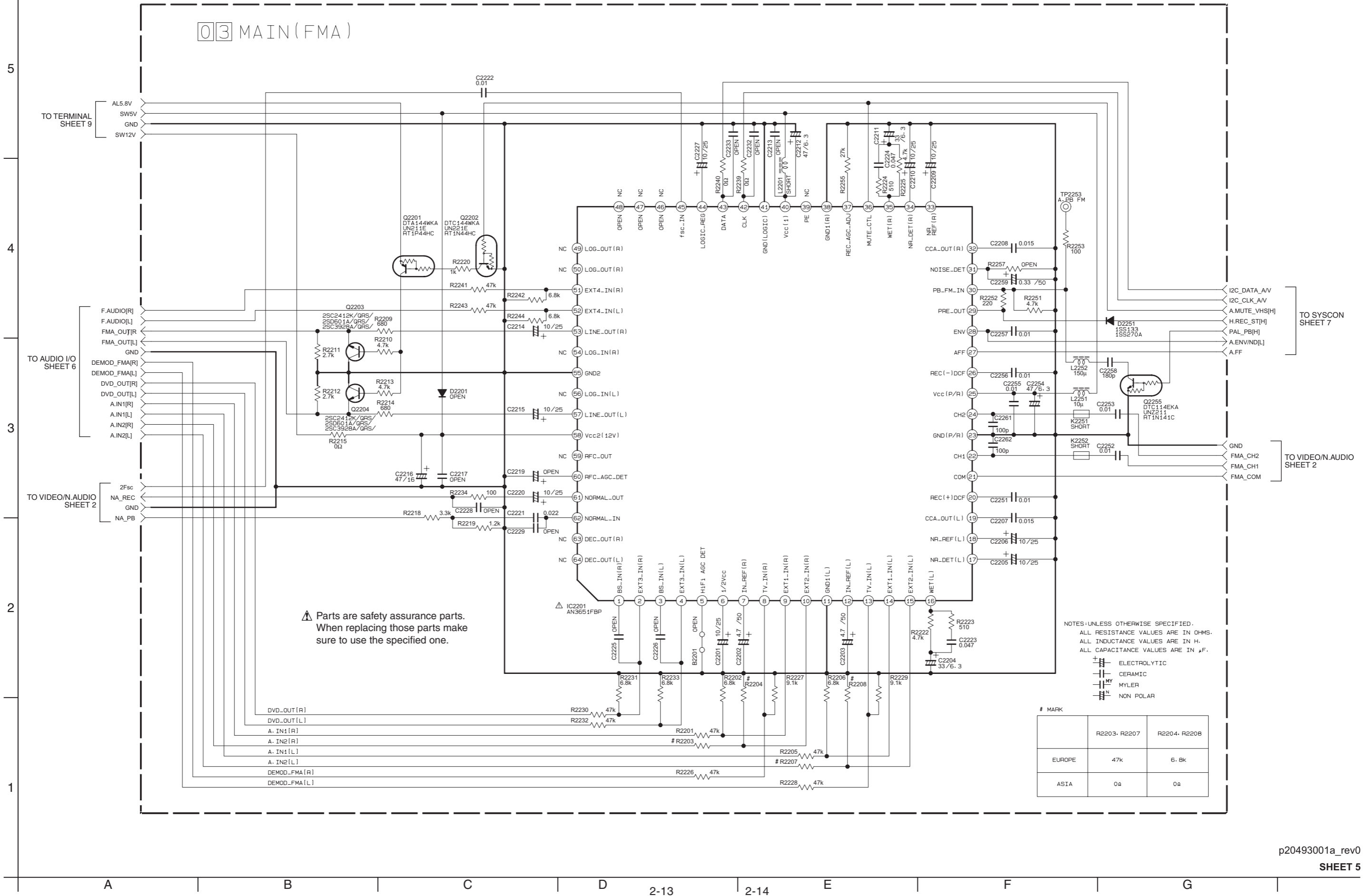

# MAIN(AUDIO I/O) SCHEMATIC DIAGRAM

03 MAIN(AUDIO I/O)

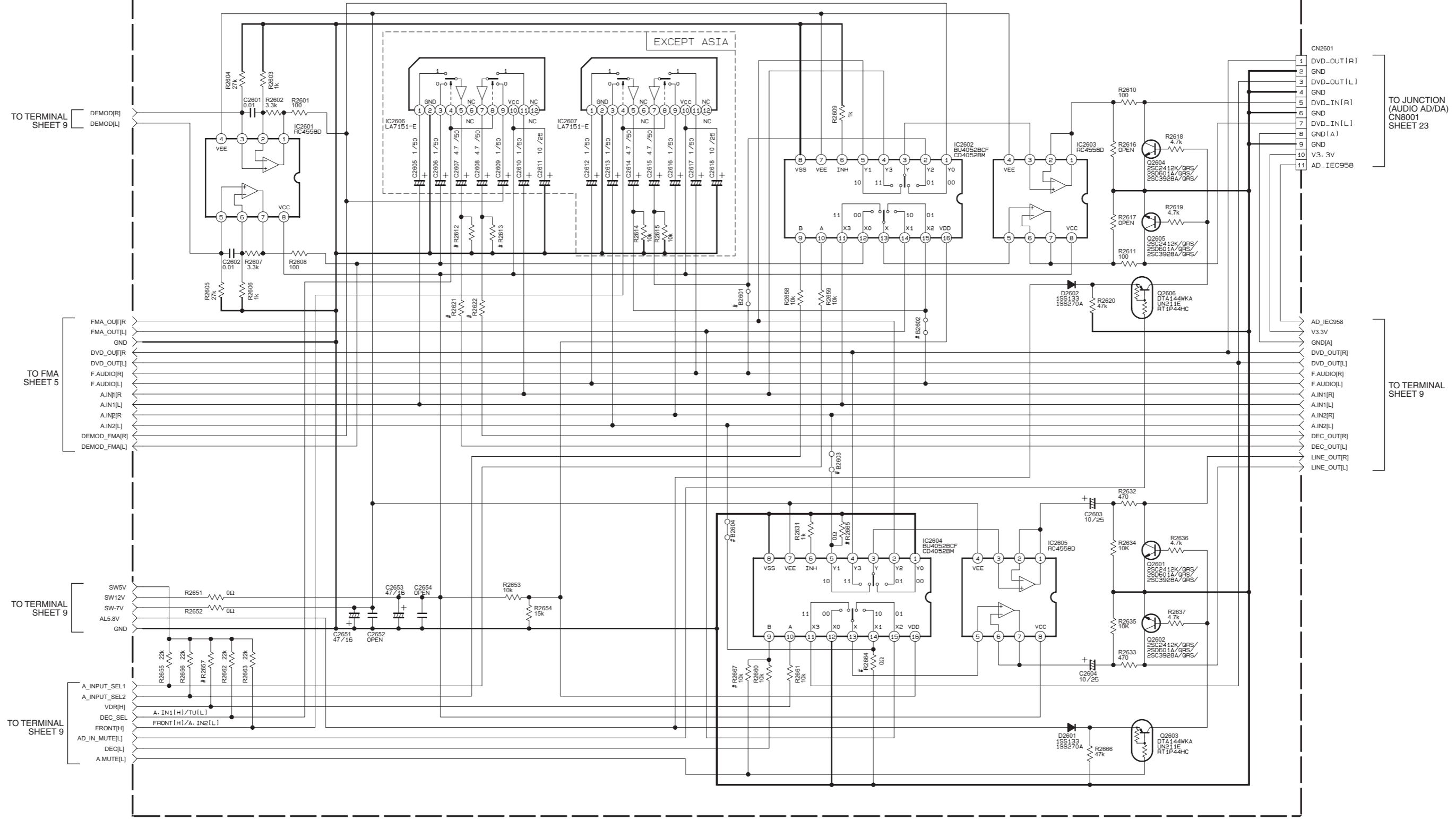

# MARK

	B2601, B2602 R2664, R2665, R2667	B2603, B2604 R2660	R2657	R2612, R2613	R2621, R2622
EUROPE	NOT USE	USE	22k	10k	330
ASIA	USE	NOT USE	1k	0Ω	NOT USE

NOTES-UNLESS OTHERWISE SPECIFIED.  
 ALL RESISTANCE VALUES ARE IN OHMS.  
 ALL INDUCTANCE VALUES ARE IN H.  
 ALL CAPACITANCE VALUES ARE IN μF.

ELECTROLYTIC  
 CERAMIC  
 MYLER  
 NON POLAR

# MAIN(SYSCON) SCHEMATIC DIAGRAM

03 MAIN(SYSCON)

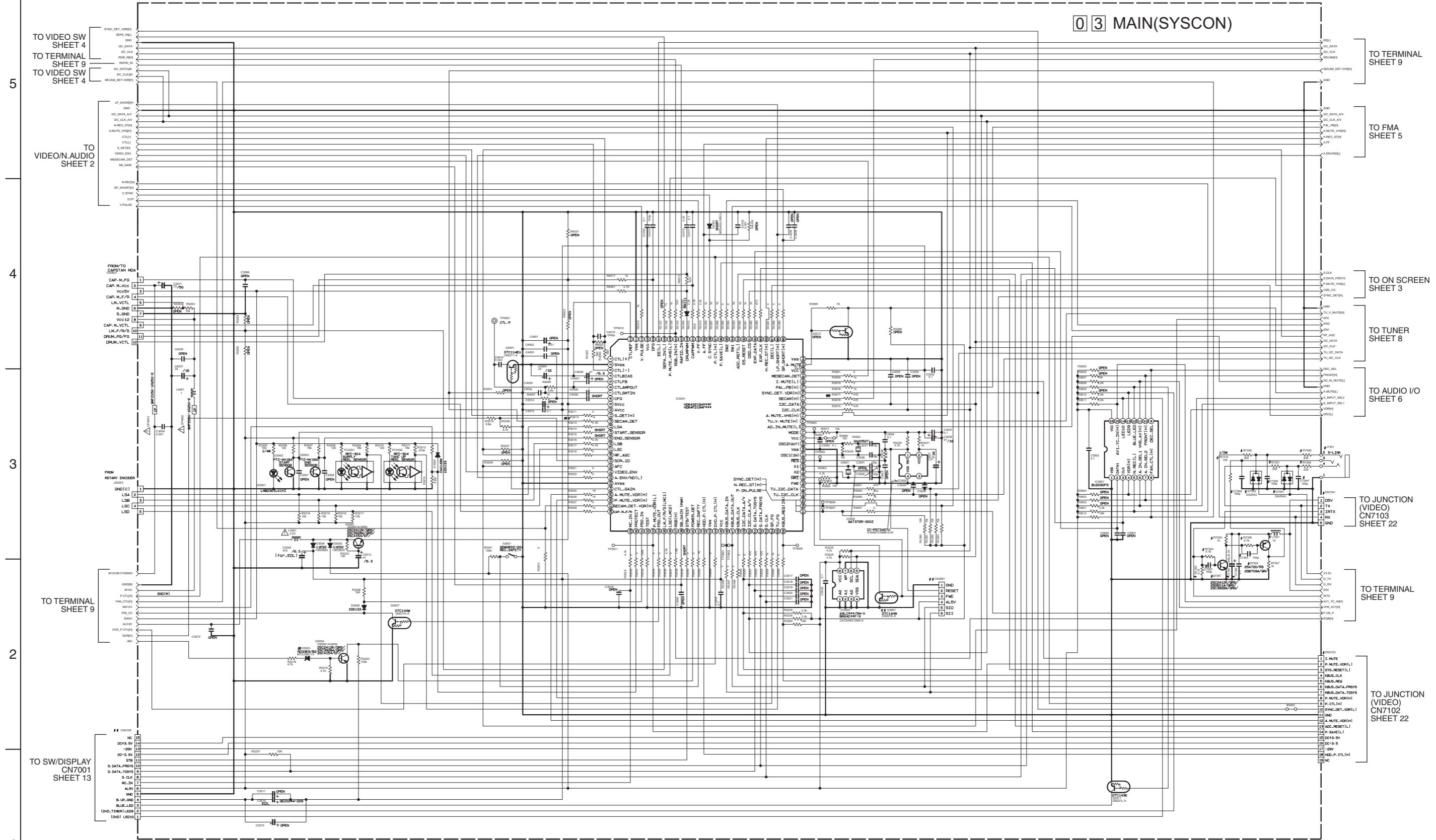

DIFFERENCE TABLE		LAST NO	VACANT NO
REV10	REV07		
SEP	O		
OTHERS	X		

NOTES: UNLESS OTHERWISE SPECIFIED, ALL RESISTANCE VALUES ARE IN OHMS. ALL DIMENSIONAL VALUES ARE IN INCHES. ALL CAPACITANCE VALUES ARE IN P.F.

— ELECTROLYTIC  
 — CERAMIC  
 — NYLON  
 — NON POLAR

**⚠** Parts are safety assurance parts. When replacing those parts make sure to use the specified one.

5  
4  
3  
2  
1

TO VIDEO SW SHEET 4  
TO TERMINAL SHEET 9  
TO VIDEO SW SHEET 4  
TO VIDEO/AUDIO SHEET 2  
FROM/TO STAN NDA  
CAP. M.F.B  
CAP. M.V.C  
VCC5V  
CAP. M.F/R  
LM.V.CTL  
M.GND  
VCC12  
CAP. M.V.C/L  
LM.F/R/S  
DRUM.PC/F  
DRUM.V.CTL  
FROM ROTARY ENCODER  
GND(C1)  
LSA  
LSB  
LSC  
LSD  
MIDUM/TV/VIDEO  
GND(E)  
MFCIN  
P.F.CIN  
FAN.CTL/CLK  
SRV  
AL.SV  
GND.F.CTL  
SCR  
48

TO TERMINAL SHEET 9  
TO FMA SHEET 5  
TO ON SCREEN SHEET 3  
TO TUNER SHEET 8  
TO AUDIO I/O SHEET 6  
TO JUNCTION (VIDEO) CN7103 SHEET 22  
TO TERMINAL SHEET 9  
TO JUNCTION (VIDEO) CN7102 SHEET 22

■ MAIN(TUNER) SCHEMATIC DIAGRAM

03 MAIN[TUNER]

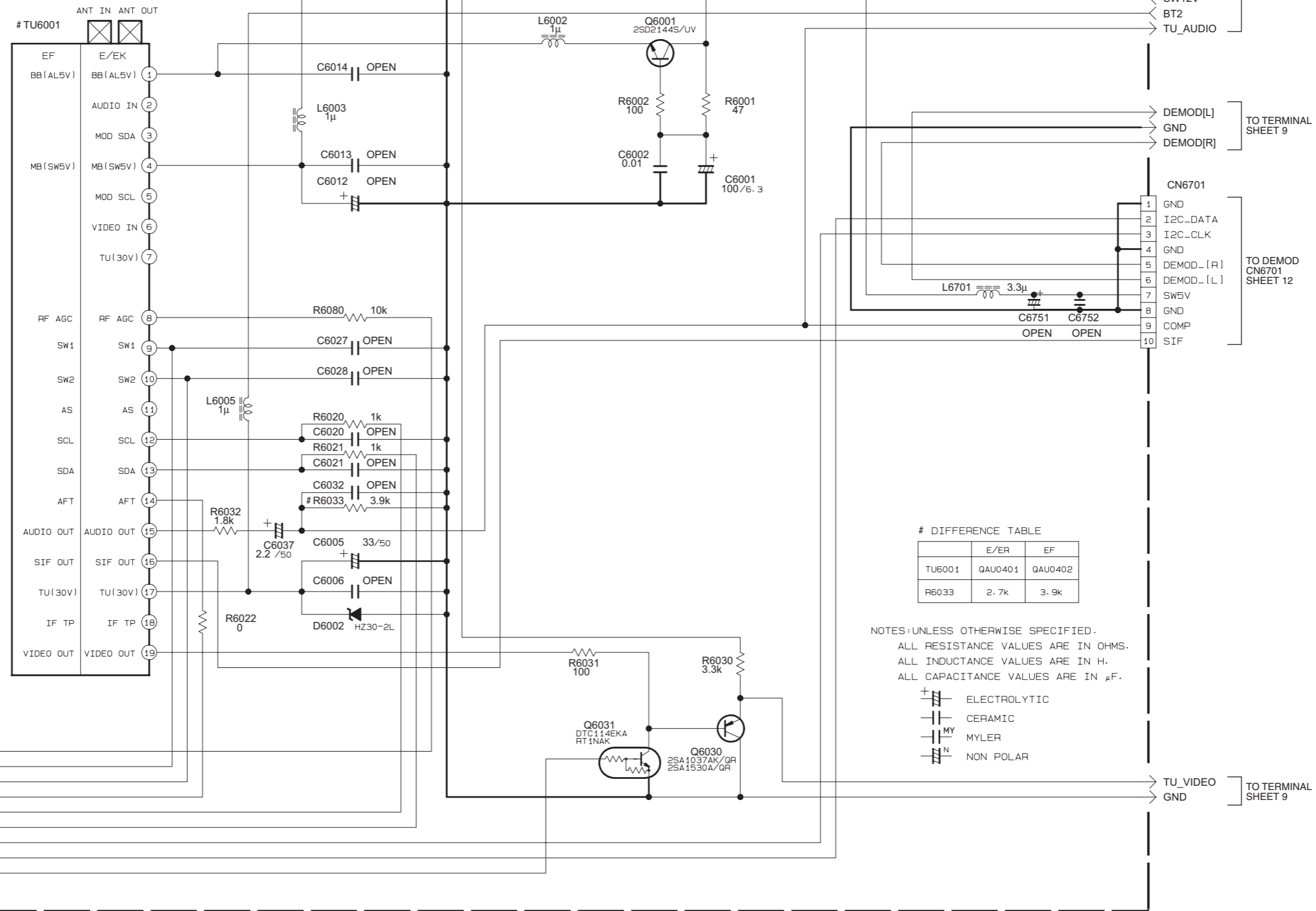

# DIFFERENCE TABLE

	E/ER	EF
TU6001	GAU0401	GAU0402
R6033	2.7k	3.9k

NOTES: UNLESS OTHERWISE SPECIFIED.  
 ALL RESISTANCE VALUES ARE IN OHMS.  
 ALL INDUCTANCE VALUES ARE IN H.  
 ALL CAPACITANCE VALUES ARE IN μF.

- ELECTROLYTIC
- CERAMIC
- MYLER
- NON POLAR

TO SYSCON SHEET 7

RF\_AGC  
 SW1  
 SW2  
 AFC  
 TU\_I2C\_CLK  
 TU\_I2C\_DATA  
 I2C\_CLK  
 I2C\_DATA  
 TU\_V\_MUTE[H]

TO TERMINAL SHEET 9

GND  
 AL5.8V  
 SW5V  
 SW12V  
 BT2  
 TU\_AUDIO

TO TERMINAL SHEET 9

DEMOD[L]  
 GND  
 DEMOD[R]

TO DEMOD CN6701 SHEET 12

CN6701

1 GND  
 2 I2C\_DATA  
 3 I2C\_CLK  
 4 GND  
 5 DEMOD-[R]  
 6 DEMOD-[L]  
 7 SW5V  
 8 GND  
 9 COMP  
 10 SIF

TO TERMINAL SHEET 9

TU\_VIDEO  
 GND

# MAIN(TERMINAL) SCHEMATIC DIAGRAM

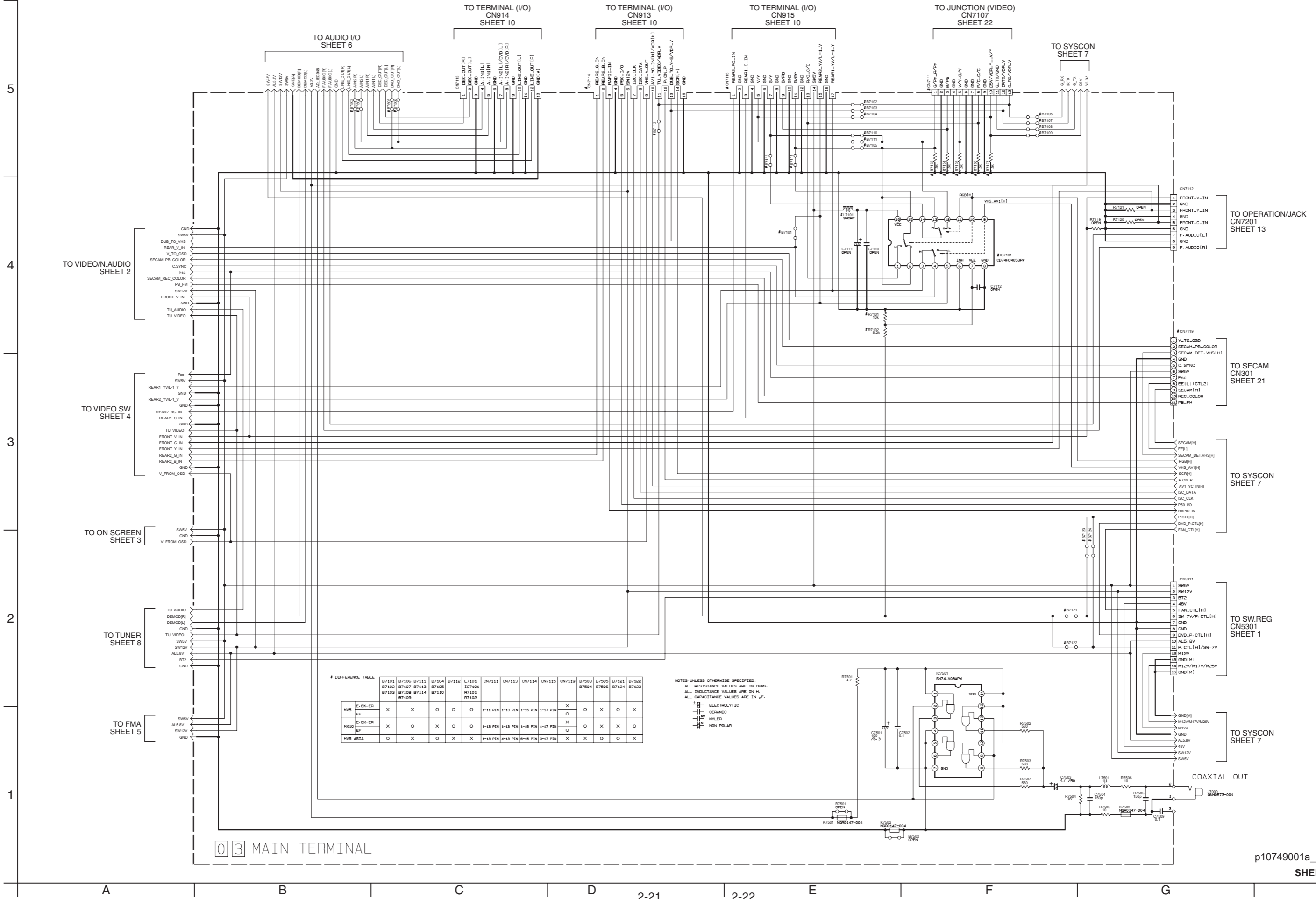

■ TERMINAL(I/O) SCHEMATIC DIAGRAM

06 TERMINAL (I/O)

5

4

3

2

1

TO MAIN(TERMINAL)  
CN7115  
SHEET 9

TO MAIN(TERMINAL)  
CN7114  
SHEET 9

TO MAIN(TERMINAL)  
CN7113  
SHEET 9

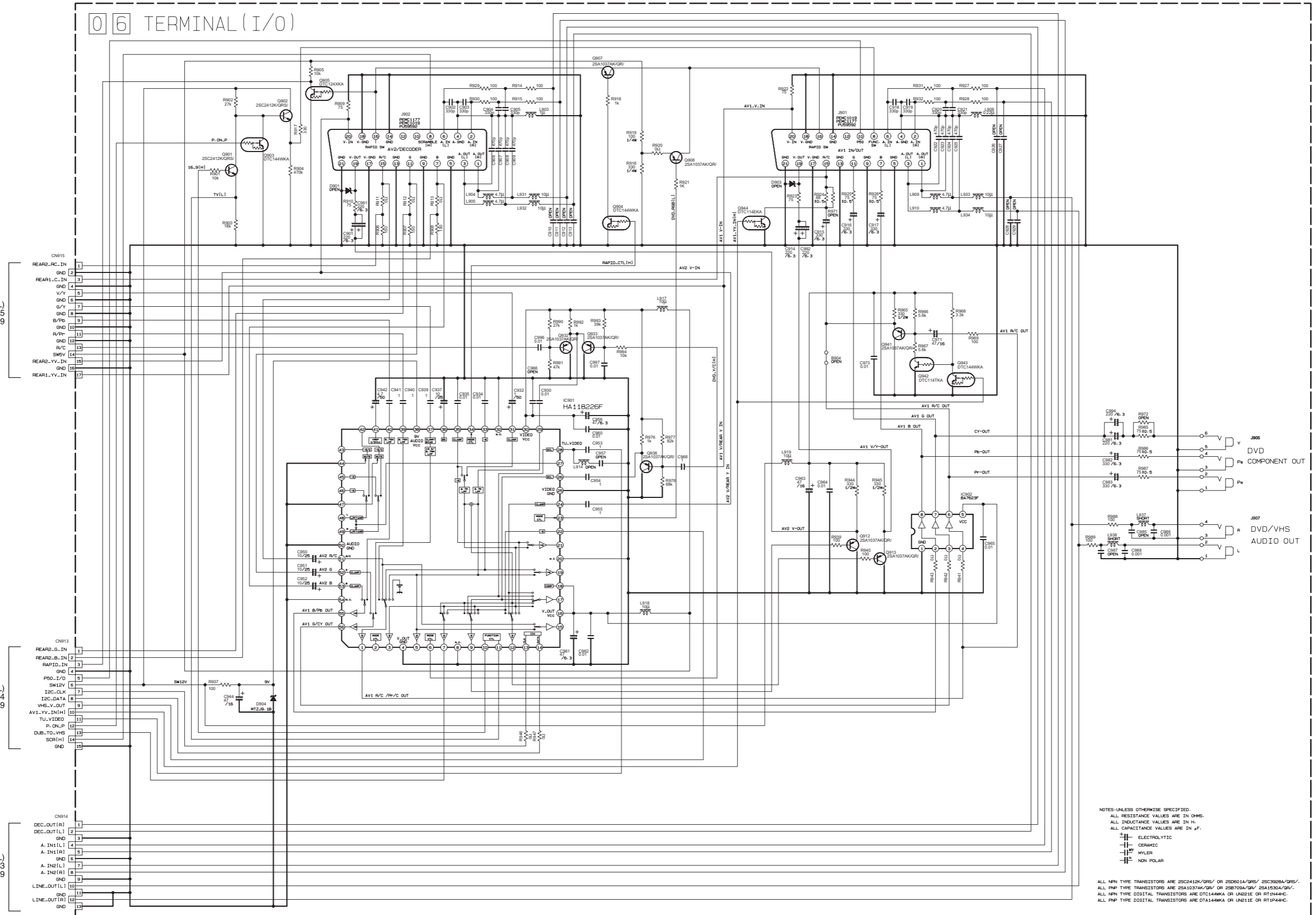

NOTES: UNLESS OTHERWISE SPECIFIED:  
ALL RESISTANCE VALUES ARE IN OHMS.  
ALL INDUCTANCE VALUES ARE IN H.  
ALL CAPACITANCE VALUES ARE IN μF.  
⊕ — ELECTROLYTIC  
— — CERAMIC  
— — MYLER  
— — NON POLAR

ALL NPN TYPE TRANSISTORS ARE 2SC2412K/GR5/ OR 2SC611A/GR5/ 2SC3928A/GR5/.  
ALL PNP TYPE TRANSISTORS ARE 2SA1037AK/GR/ OR 2SB709A/GR/ 2SA1530A/GR/.  
ALL NPN TYPE DIGITAL TRANSISTORS ARE DTC1449KA OR UN221E OR RT15N44C.  
ALL PNP TYPE DIGITAL TRANSISTORS ARE DT1449KA OR UN211E OR RT15P44C.

DC/DC CONV SCHEMATIC DIAGRAM

1 1 DC/DC CONV

##MARK ELEMENTS ARE NOT MOUNTED

NOTES: UNLESS OTHERWISE SPECIFIED,  
 ALL RESISTANCE VALUES ARE IN OHMS.  
 ALL INDUCTANCE VALUES ARE IN H.  
 ALL CAPACITANCE VALUES ARE IN μF.

- ELECTROLYTIC
- CERAMIC
- MYLER
- NON POLAR

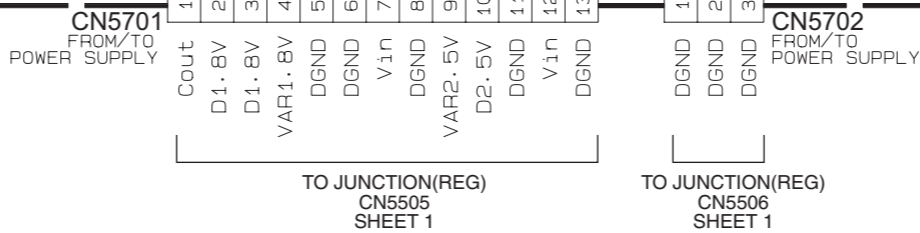
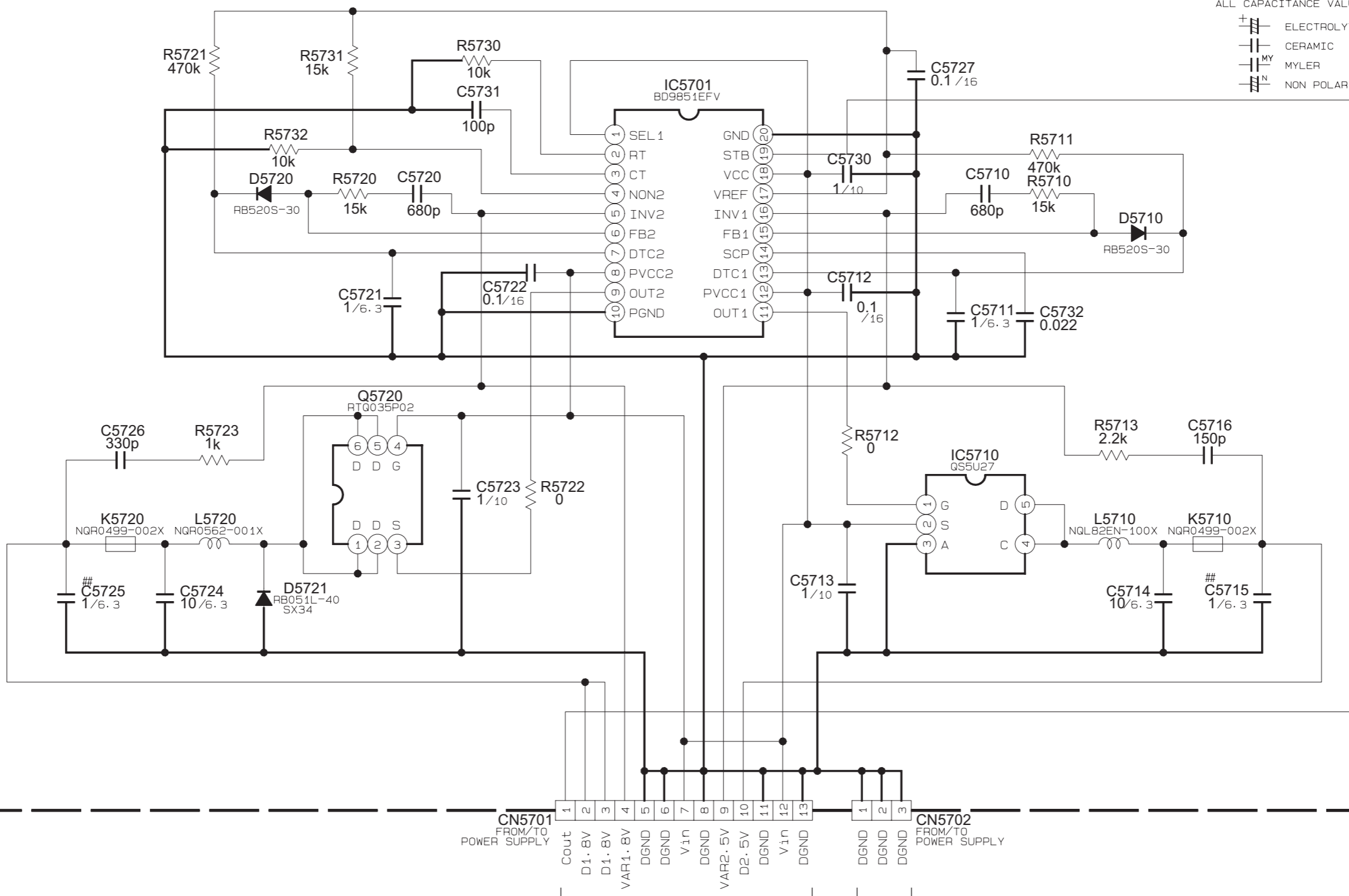

■ DEMOD SCHEMATIC DIAGRAM

1 4 DEMOD

TO MAIN(TUNER)  
CN6701  
SHEET 8

# DIFFERENCE TABLE

FUNCTION	SYMBOL	EZ/ER/EL/EY EU/EK/AA/AG	EF
PREAMP	R6701-R6704, R6705, R6706, C6701-C6703, C6705- L6702, Q6701	X	X
MOND IN	C6724, K6707	X	○

NOTES: UNLESS OTHERWISE SPECIFIED,  
ALL RESISTANCE VALUES ARE IN OHMS.  
ALL INDUCTANCE VALUES ARE IN H.  
ALL CAPACITANCE VALUES ARE IN μF.

- ELECTROLYTIC
- CERAMIC
- MYLER
- NON POLAR

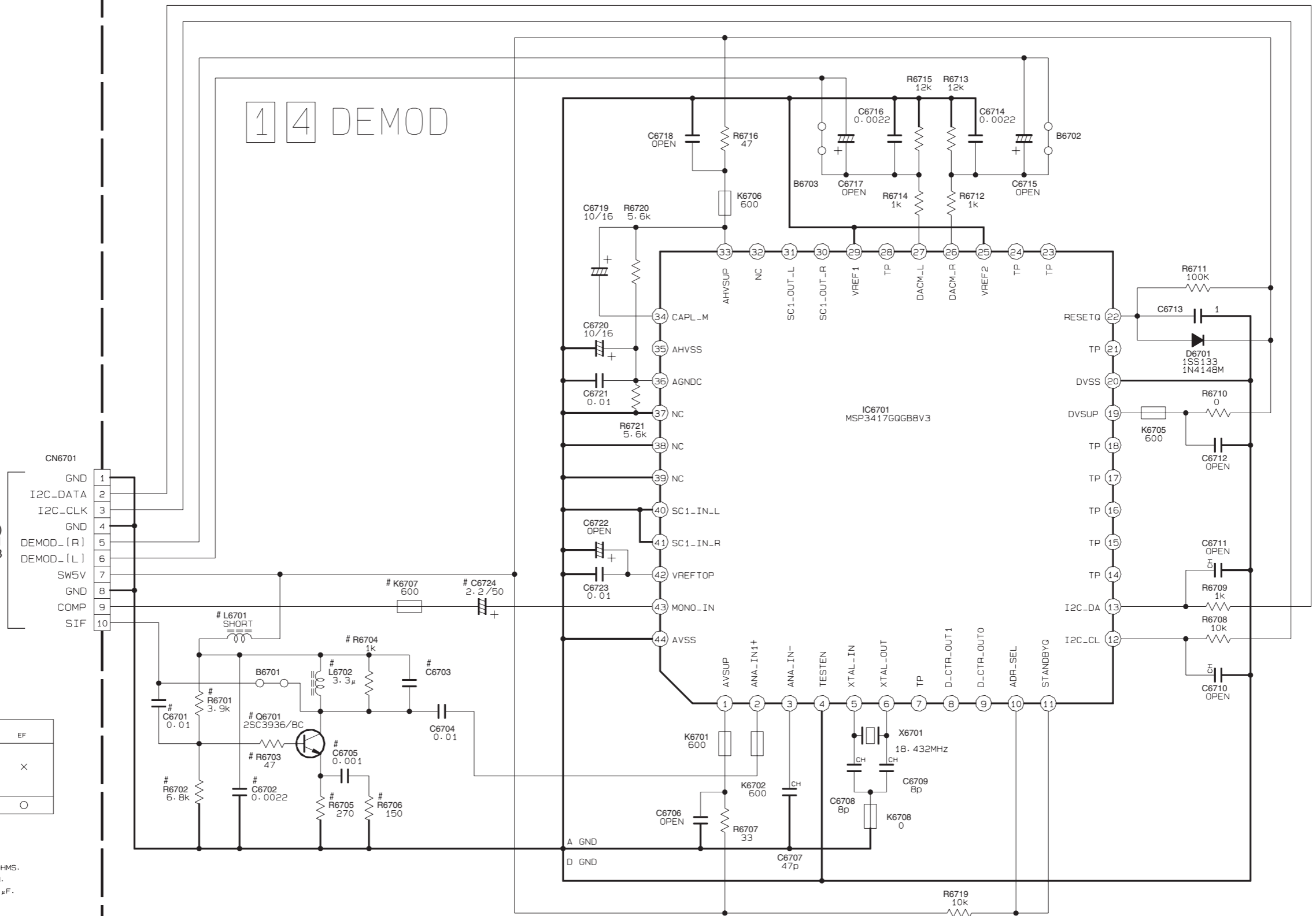



■ OPERATION/JACK , SWITCH/DISPLAY AND DV JACK SCHEMATIC DIAGRAM

5  
4  
3  
2  
1

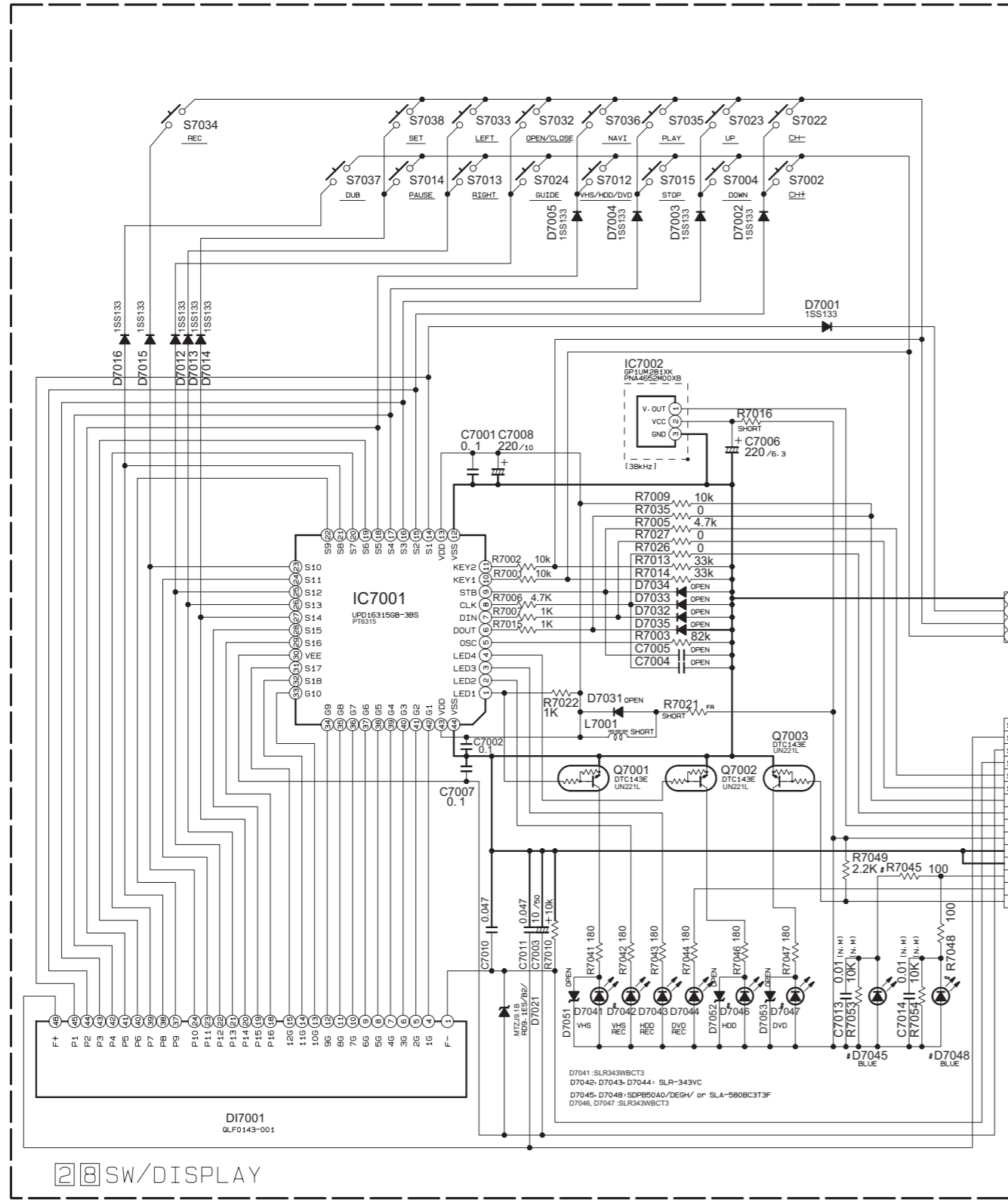

REF	DESCRIPTION	VALUE	TYPE	PACKAGE
D7041	D7046	C7001	L7002	
D7042	D7047	C7002	L7003	
D7043	D7048	C7003		
D7044	D7049	C7004		
D7045	D7050	C7005		
D7046	D7051	C7006		
D7047	D7052	C7007		
D7048	D7053	C7008		
D7049	D7054	C7009		
D7050	D7055	C7010		
D7051	D7056	C7011		
D7052	D7057	C7012		
D7053	D7058	C7013		
D7054	D7059	C7014		
D7055	D7060	C7015		
D7056	D7061	C7016		
D7057	D7062	C7017		
D7058	D7063	C7018		
D7059	D7064	C7019		
D7060	D7065	C7020		
D7061	D7066	C7021		
D7062	D7067	C7022		
D7063	D7068	C7023		
D7064	D7069	C7024		
D7065	D7070	C7025		
D7066	D7071	C7026		
D7067	D7072	C7027		
D7068	D7073	C7028		
D7069	D7074	C7029		
D7070	D7075	C7030		
D7071	D7076	C7031		
D7072	D7077	C7032		
D7073	D7078	C7033		
D7074	D7079	C7034		
D7075	D7080	C7035		
D7076	D7081	C7036		
D7077	D7082	C7037		
D7078	D7083	C7038		
D7079	D7084	C7039		
D7080	D7085	C7040		
D7081	D7086	C7041		
D7082	D7087	C7042		
D7083	D7088	C7043		
D7084	D7089	C7044		
D7085	D7090	C7045		
D7086	D7091	C7046		
D7087	D7092	C7047		
D7088	D7093	C7048		
D7089	D7094	C7049		
D7090	D7095	C7050		
D7091	D7096	C7051		
D7092	D7097	C7052		
D7093	D7098	C7053		
D7094	D7099	C7054		
D7095	D7100	C7055		
D7096	D7101	C7056		
D7097	D7102	C7057		
D7098	D7103	C7058		
D7099	D7104	C7059		
D7100	D7105	C7060		

NOTES: UNLESS OTHERWISE SPECIFIED:  
ALL RESISTANCE VALUES ARE IN OHMS.  
ALL INDUCTANCE VALUES ARE IN H.  
ALL CAPACITANCE VALUES ARE IN μF.

⊖ ELECTROLYTIC  
⊖ CERAMIC  
⊖ MYLAR  
⊖ NON POLAR

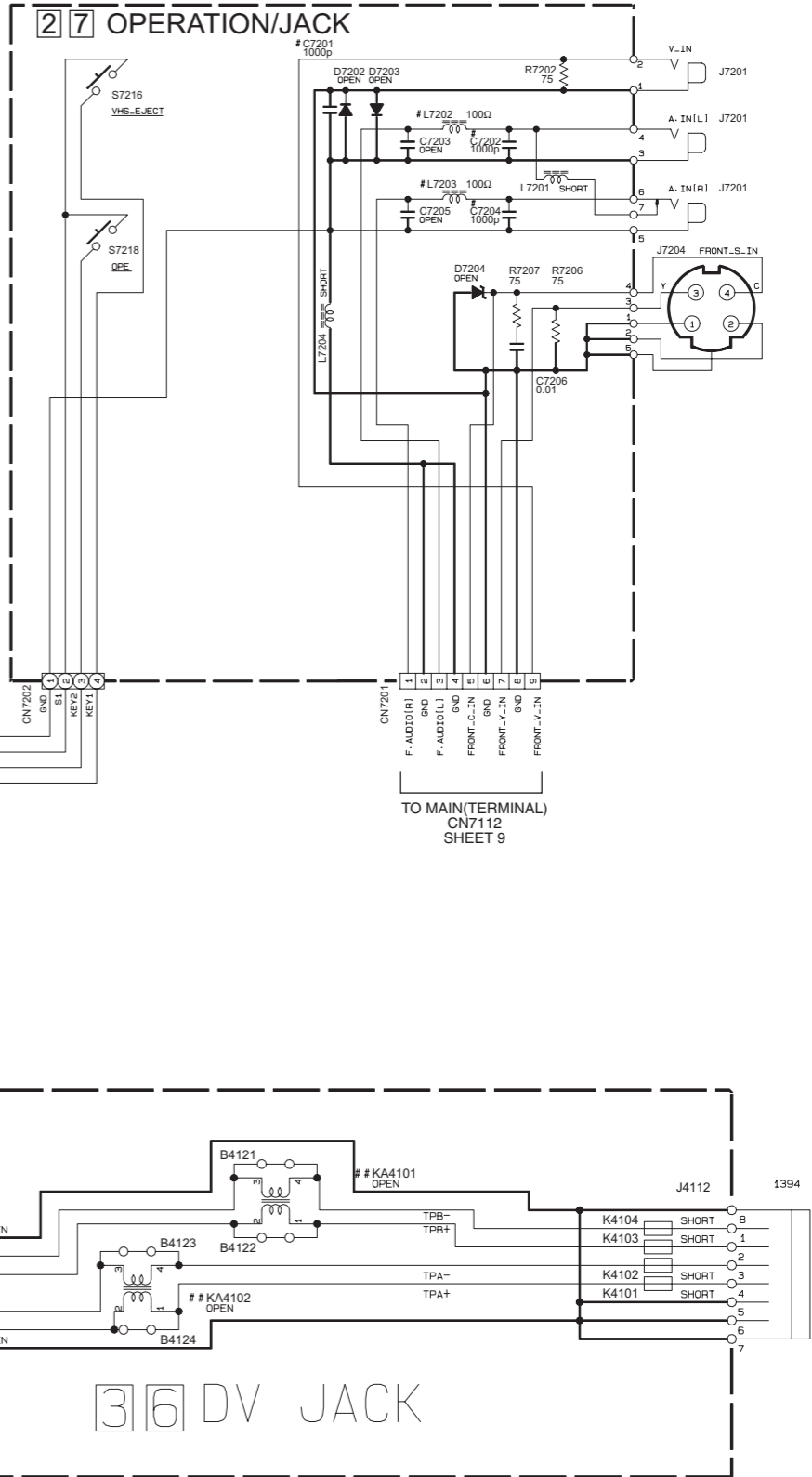

TO MAIN(SYSCON)  
CN3102  
SHEET 7

TO DIGITAL  
(1394PHY)  
CN1801  
SHEET 18

TO MAIN(TERMINAL)  
CN7112  
SHEET 9

**DIGITAL(VIDEO IF) SCHEMATIC DIAGRAM**

**5 0 DIGITAL(VIDEO IF)**

Q1004-Q1005	
R1045-R1047, R1055-R1063	X
DOM4US	X
EURD	O

NOTES: UNLESS OTHERWISE SPECIFIED:  
 ALL RESISTANCE VALUES ARE IN OHMS.  
 ALL INDUCTANCE VALUES ARE IN H.  
 ALL CAPACITANCE VALUES ARE IN P.F.  
 ⚡ ELECTROLYTIC  
 C CERAMIC

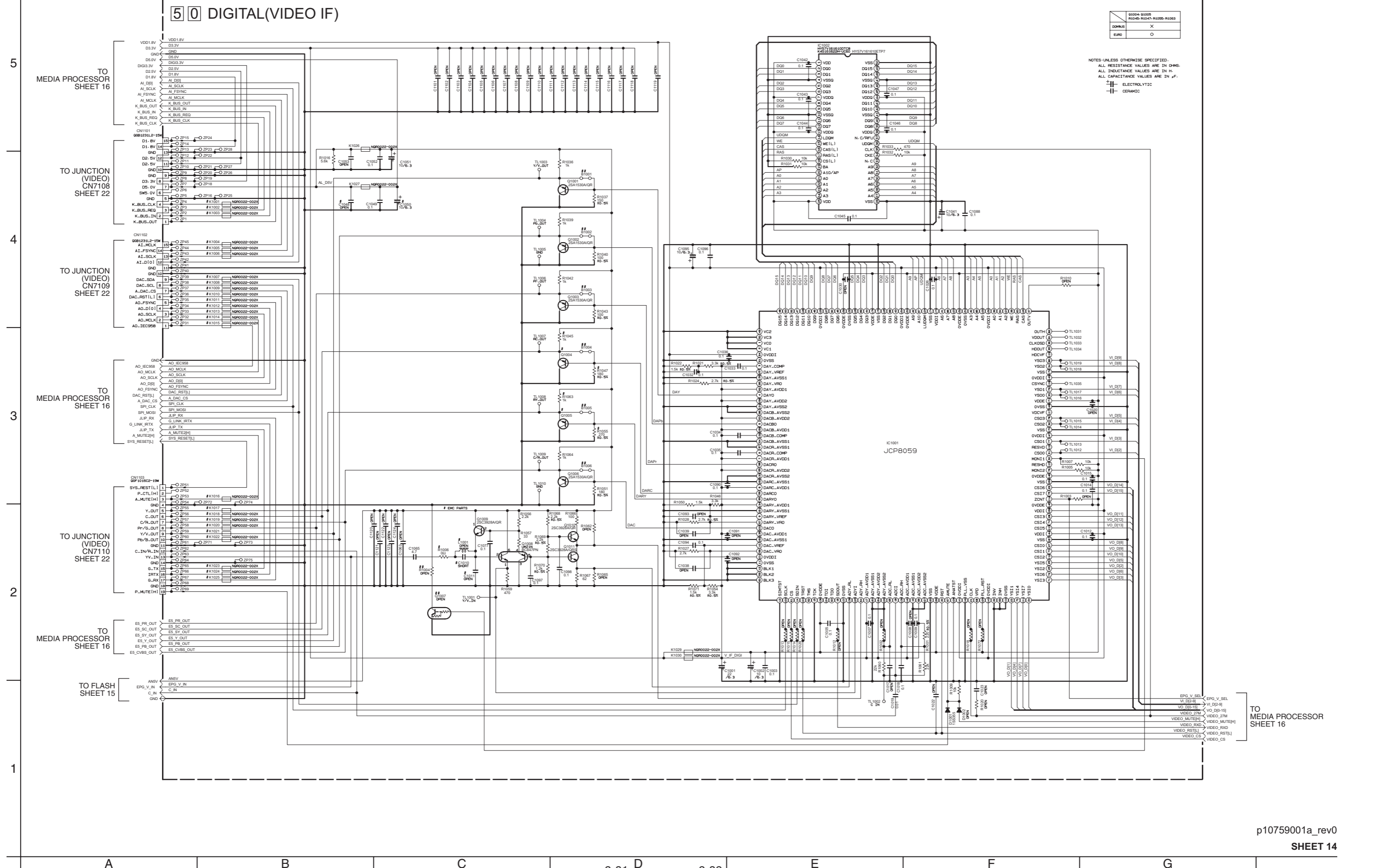

TO MEDIA PROCESSOR SHEET 16

# DIGITAL(FLASH ROM/EPG) SCHEMATIC DIAGRAM

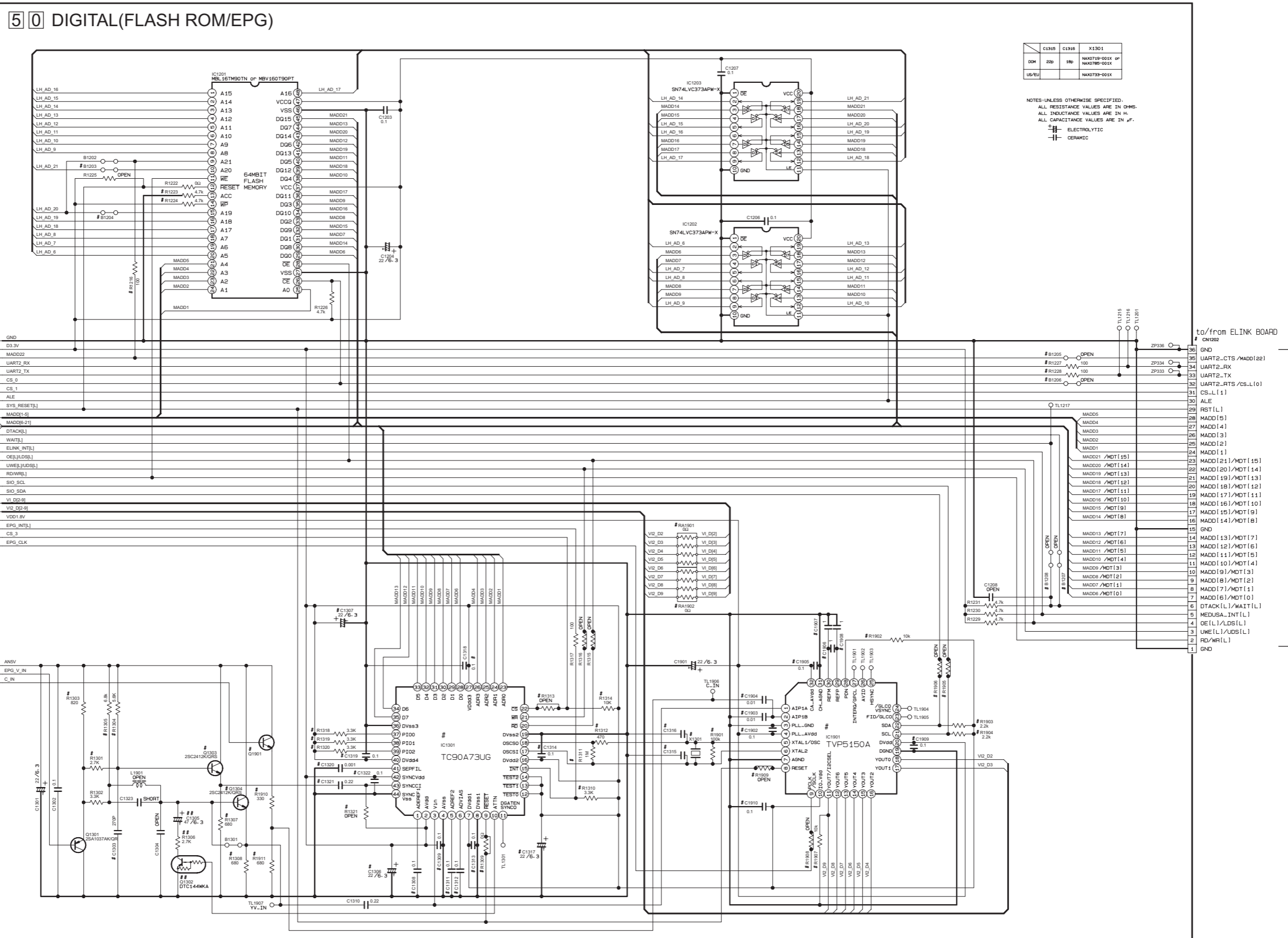

	C1315	C1316	X1301
DOM	22p	18p	NAK0719-001X or NAK0786-001X
UE/EU			NAK0733-001X

NOTES-UNLESS OTHERWISE SPECIFIED:  
 ALL RESISTANCE VALUES ARE IN OHMS.  
 ALL INDUCTANCE VALUES ARE IN H.  
 ALL CAPACITANCE VALUES ARE IN  $\mu$ F.  
 ELECTROLYTIC  
 CERAMIC

TO MEDIA PROCESSOR SHEET 16

TO VIDEO IF SHEET 14

NOT USED

**DIGITAL(MEDIA PROCESSOR) SCHEMATIC DIAGRAM**

**50 DIGITAL(MEDIA PROCESSOR)**

5

4

3

2

1

TO DDR SDRAM SHEET 17

TO FLASH SHEET 15

TO 1394PHY SHEET 18

TO ATAPI IF SHEET 19

TO VIDEO IF SHEET 14

TO FLASH SHEET 15

NOT USED

TO VIDEO IF SHEET 14

TO 1394PHY SHEET 18

NOT USED

TO FLASH SHEET 15

TO VIDEO IF SHEET 14

NOT USED

TO 1394PHY SHEET 18

TO VIDEO IF SHEET 14

TO VIDEO IF SHEET 14

TO FLASH SHEET 15

TO DDR SDRAM SHEET 17

TO FLASH SHEET 15

TO ATAPI SHEET 19

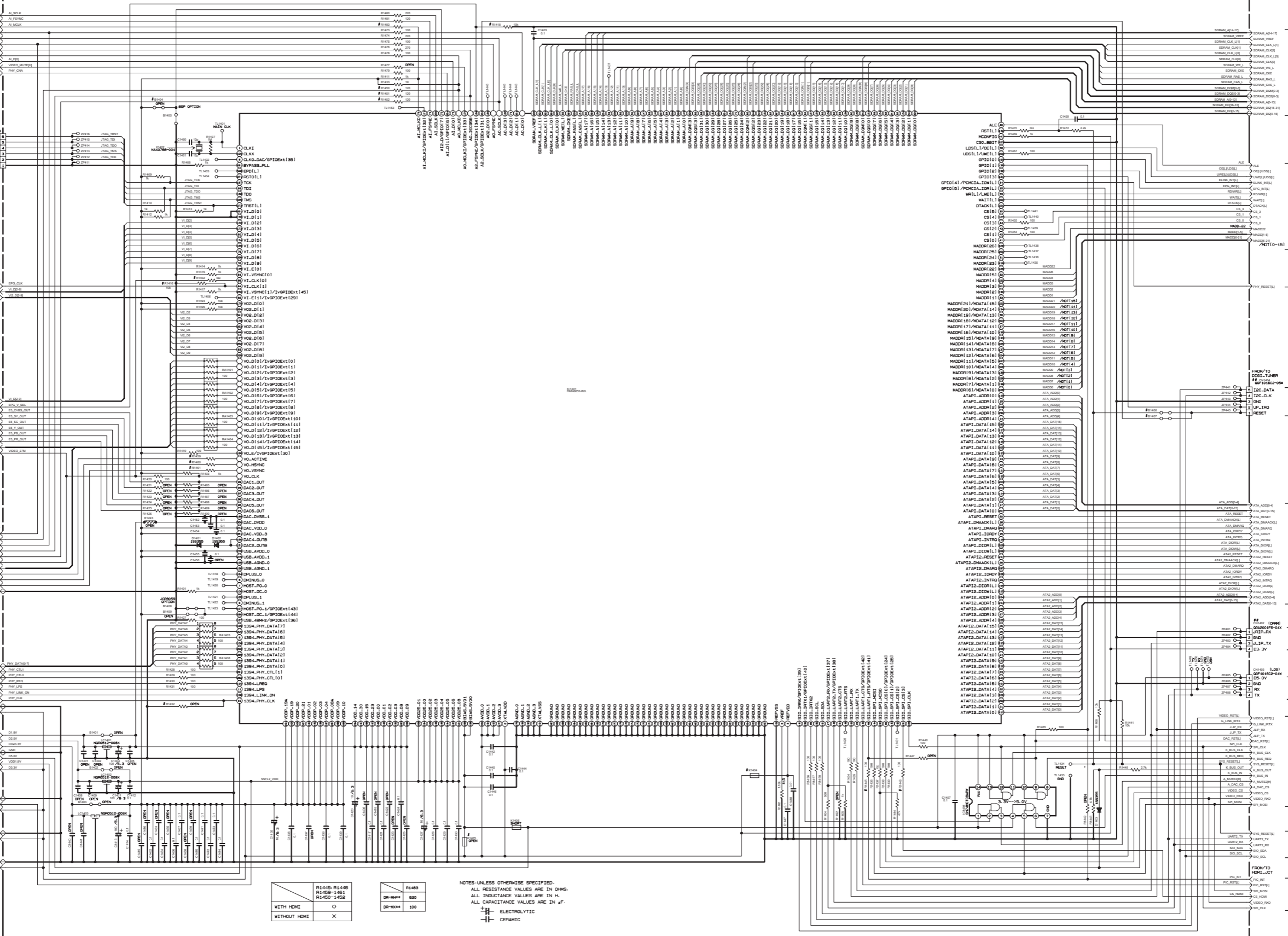

R1463	
DR-HDMI	200
DR-HDMI	100

NOTES: UNLESS OTHERWISE SPECIFIED,  
 ALL RESISTANCE VALUES ARE IN OHMS.  
 ALL INDUCTANCE VALUES ARE IN nH.  
 ALL CAPACITANCE VALUES ARE IN uF.  
 ELECTROLYTIC  
 CERAMIC

# DIGITAL(DDR SDRAM) SCHEMATIC DIAGRAM

## 5 0 DIGITAL(DDR SDRAM)

IC1701	K1701	B1702
LP2995	X	O
DS3233	O	X

NOTES-UNLESS OTHERWISE SPECIFIED,  
ALL RESISTANCE VALUES ARE IN OHMS.  
ALL INDUCTANCE VALUES ARE IN nH.  
ALL CAPACITANCE VALUES ARE IN nF.  
ELECTROLYTIC  
CERAMIC

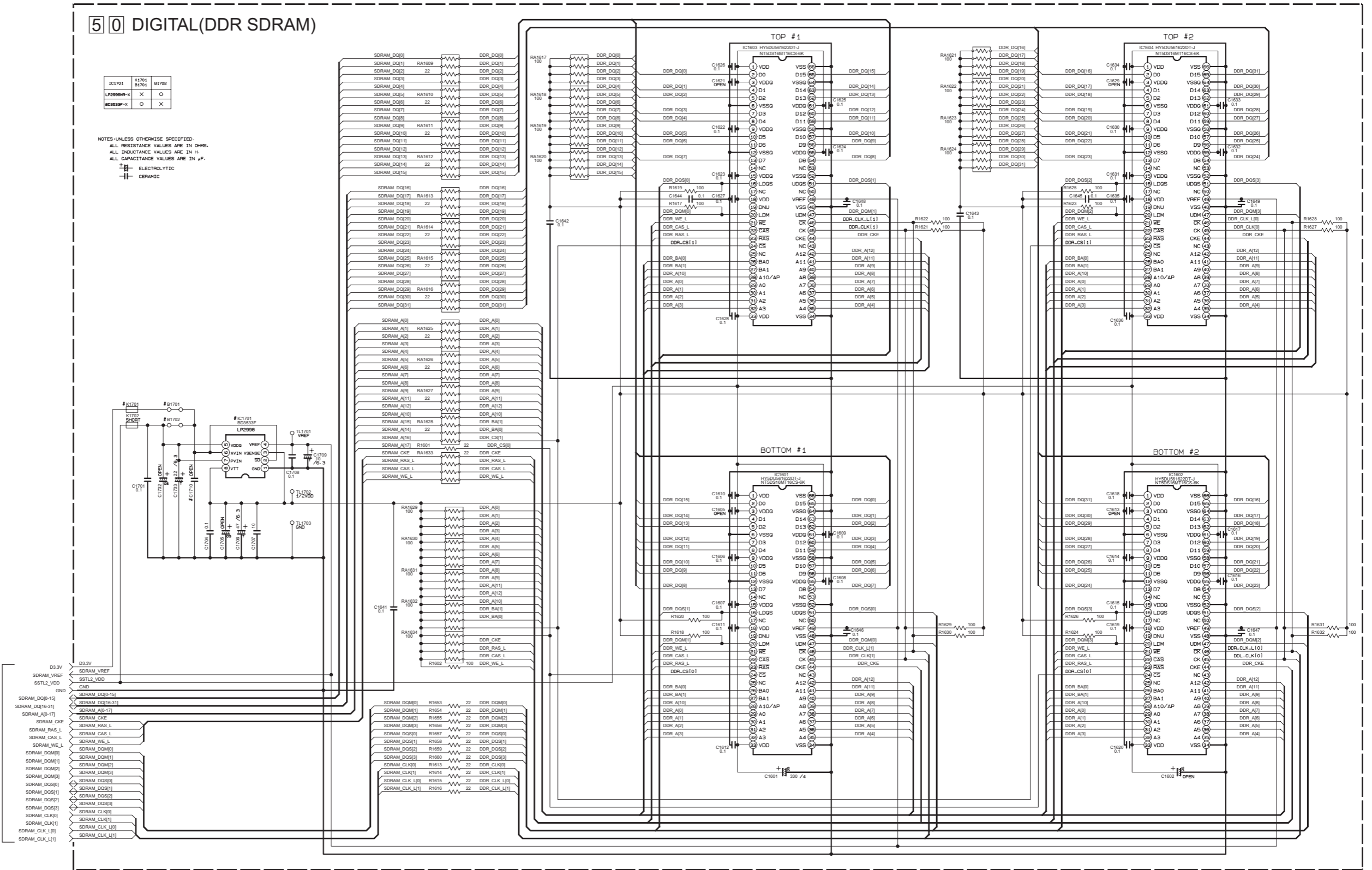

TO MEDIA PROCESSOR SHEET 16

**DIGITAL(1394PHAY) SCHEMATIC DIAGRAM**

5  
4  
3  
2  
1

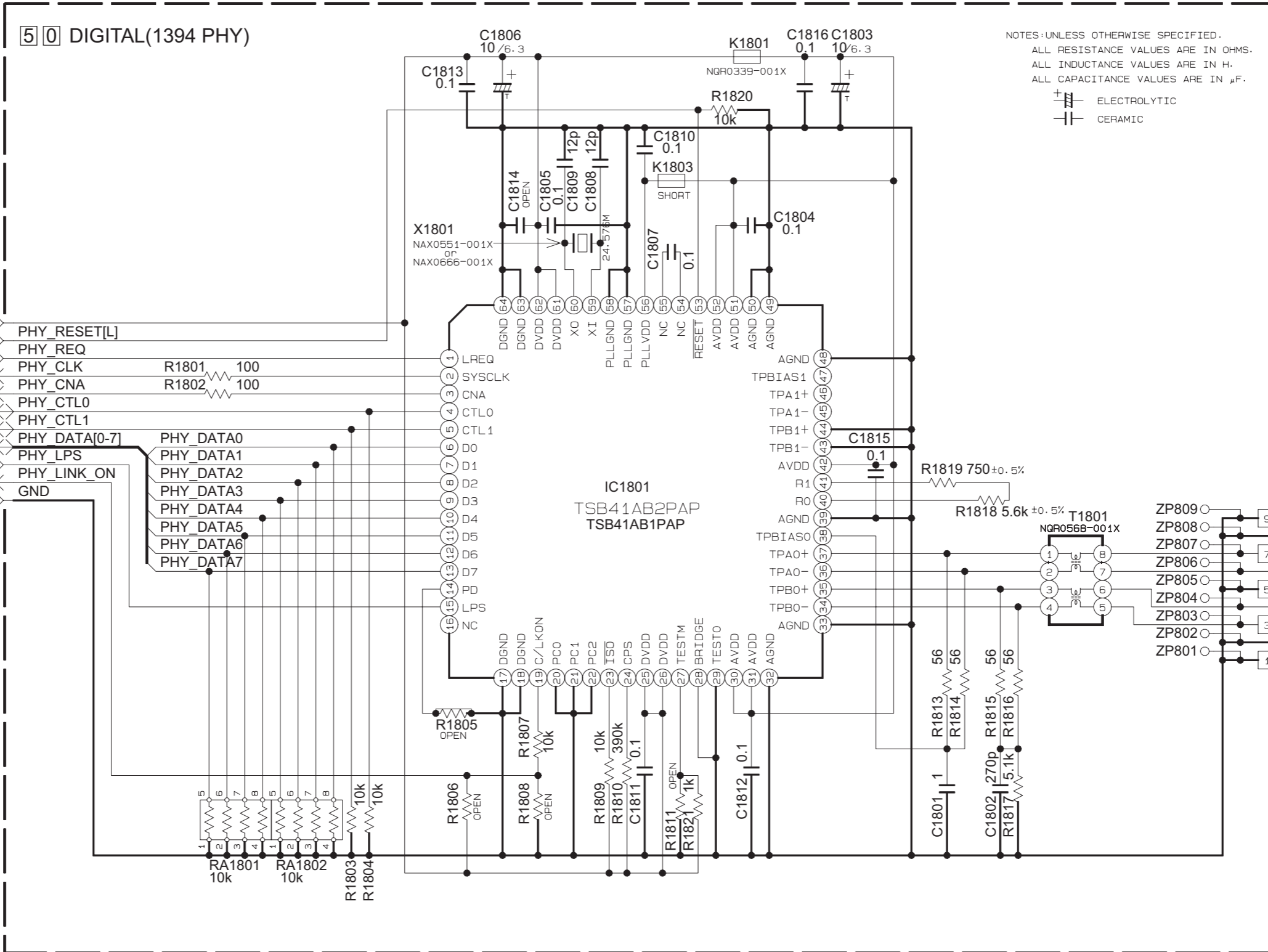

A B C D E F G

2-39

2-40

# DIGITAL(ATAPI IF) SCHEMATIC DIAGRAM

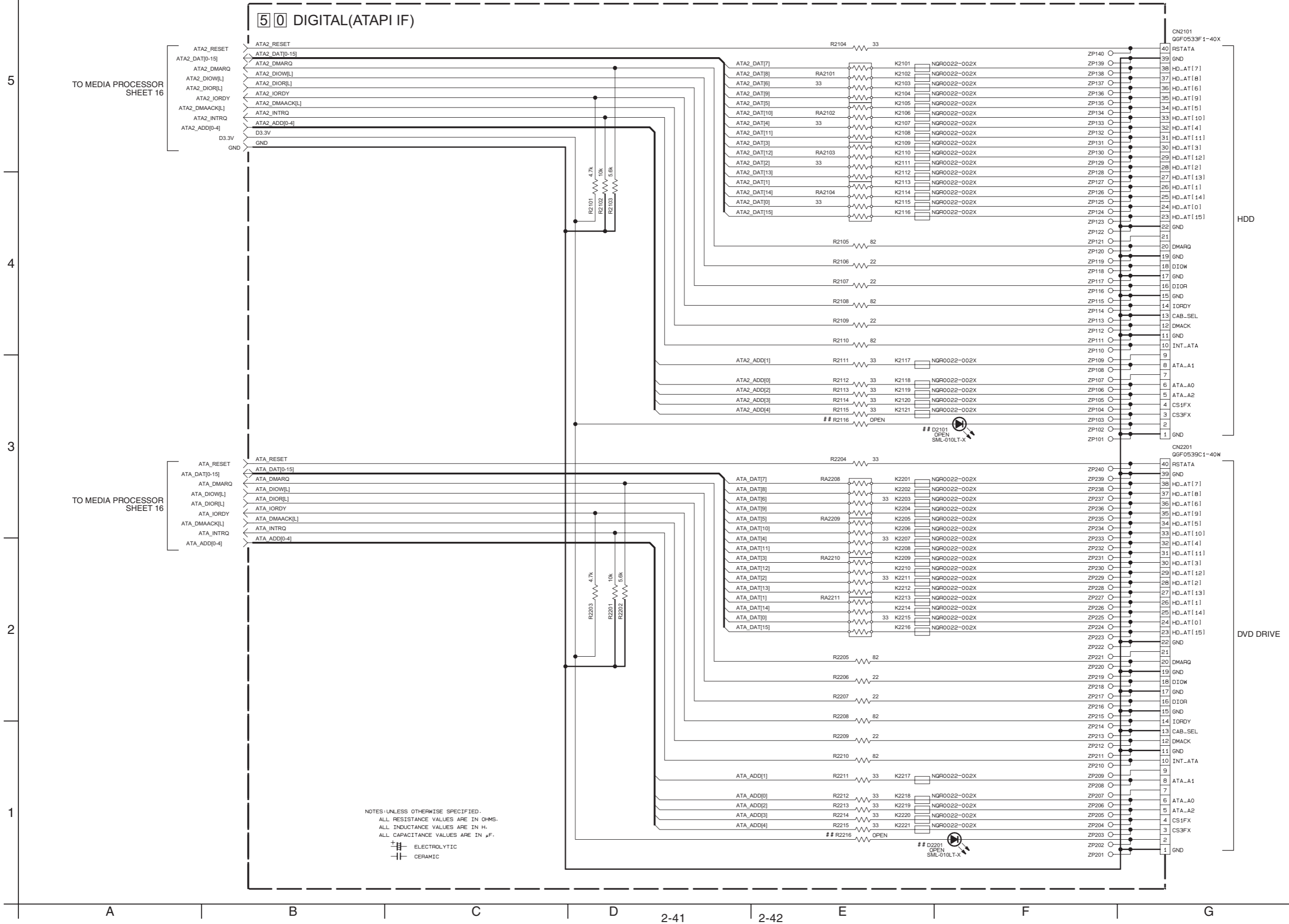

RGB Y/C SCHEMATIC DIAGRAM

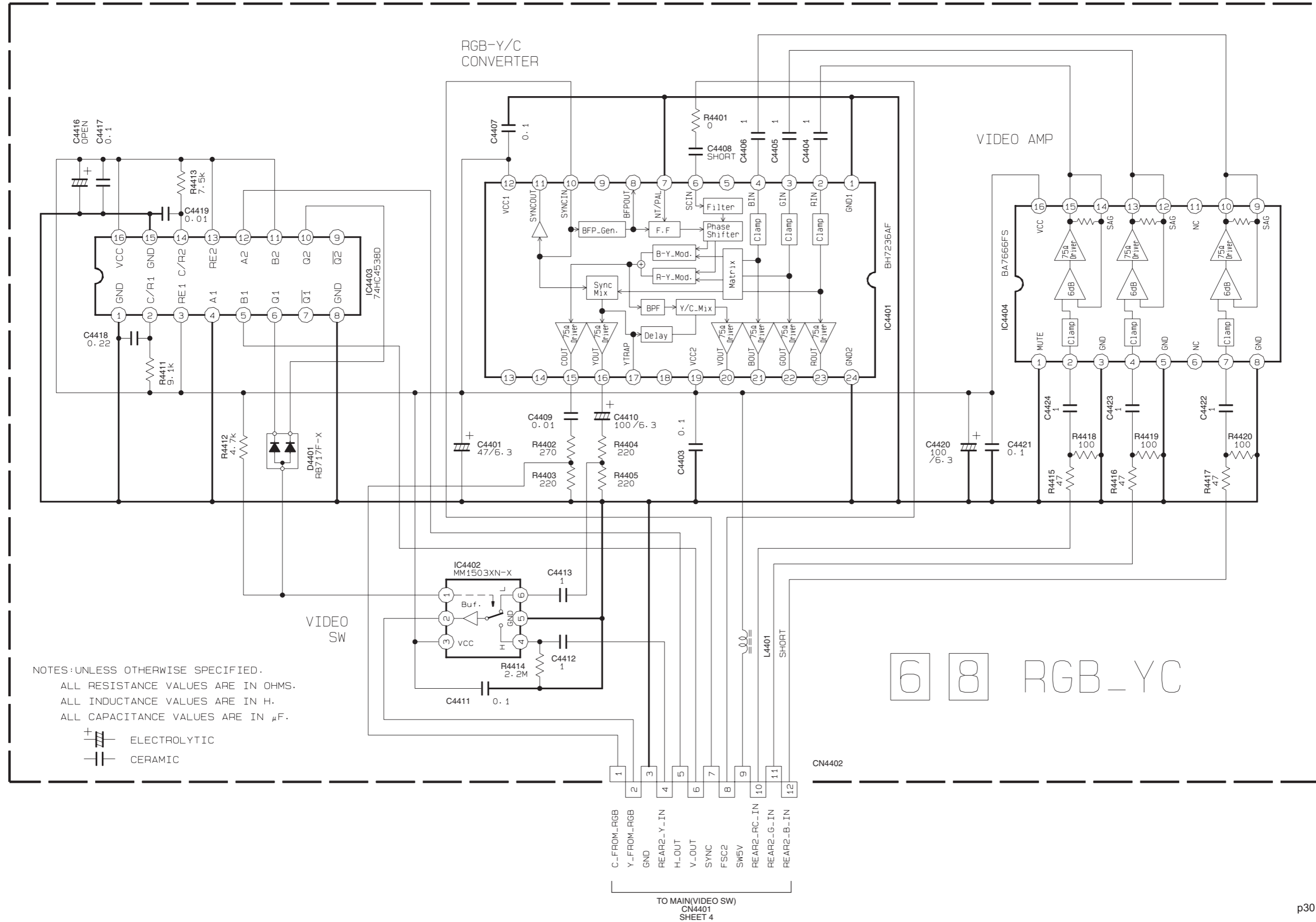



SECAM SCHEMATIC DIAGRAM [DR-MX10SEF ONLY]

88 SECAM

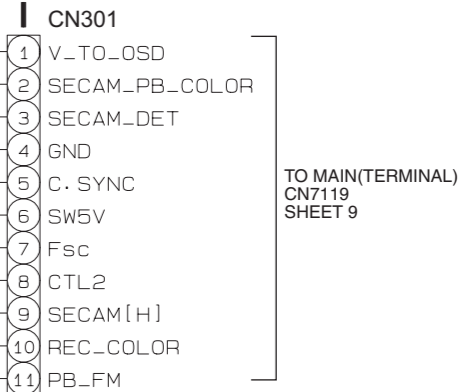
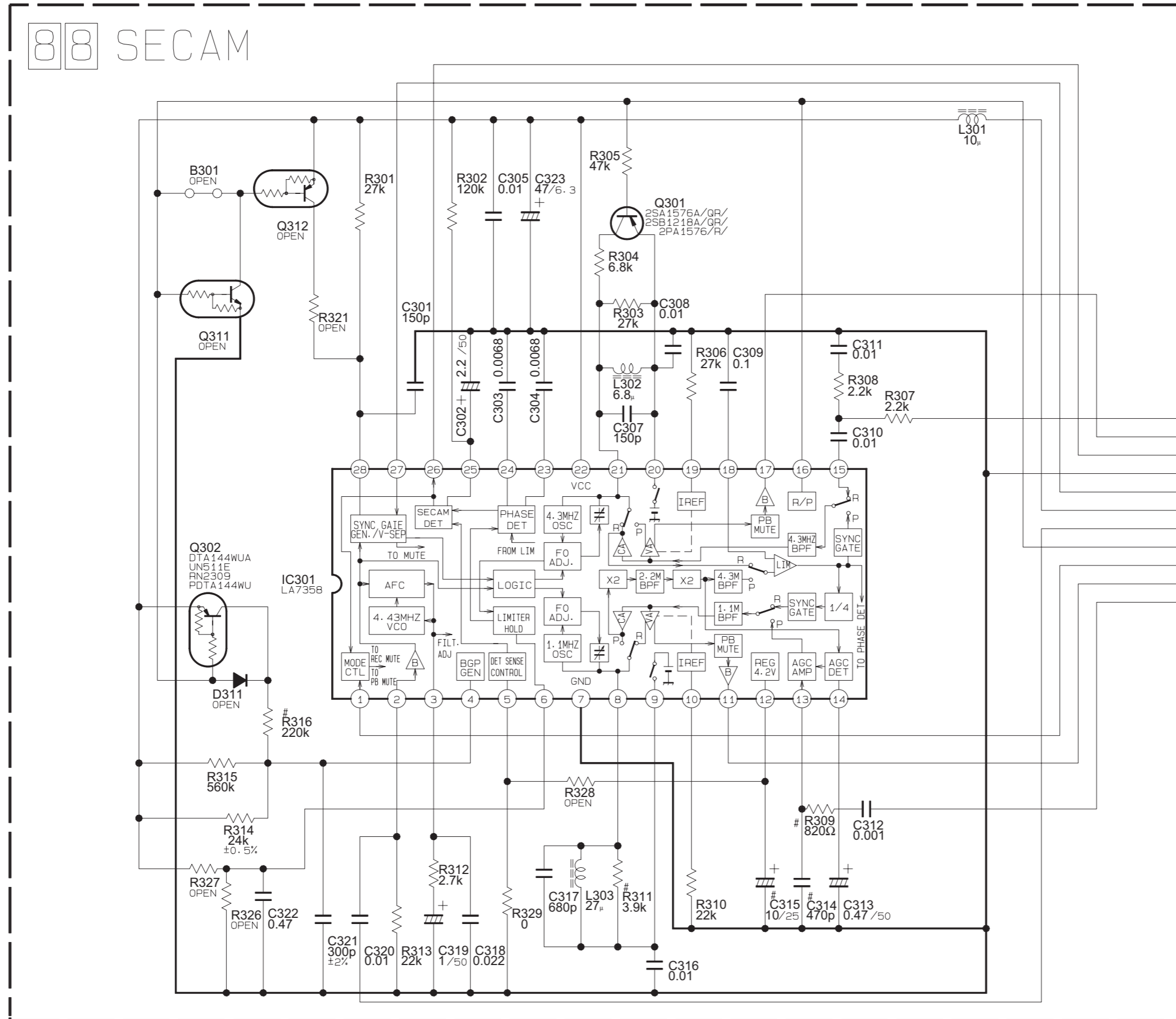

NOTES: UNLESS OTHERWISE SPECIFIED.  
ALL RESISTANCE VALUES ARE IN OHMS.  
ALL INDUCTANCE VALUES ARE IN H.  
ALL CAPACITANCE VALUES ARE IN  $\mu$ F.

ELECTROLYTIC  
 CERAMIC  
 MYLER  
 NON POLAR

# SECAM DIFFERENCE TABLE

	R309	R311	R316	C314	C315
HIFI MODELS	SHORT	3.9K	220K	X	10/25
S-VHS MODELS	B20	4.7K	120K	470p	1/50

# JUNCTION(VIDEO) SCHEMATIC DIAGRAM

5  
4  
3  
2  
1

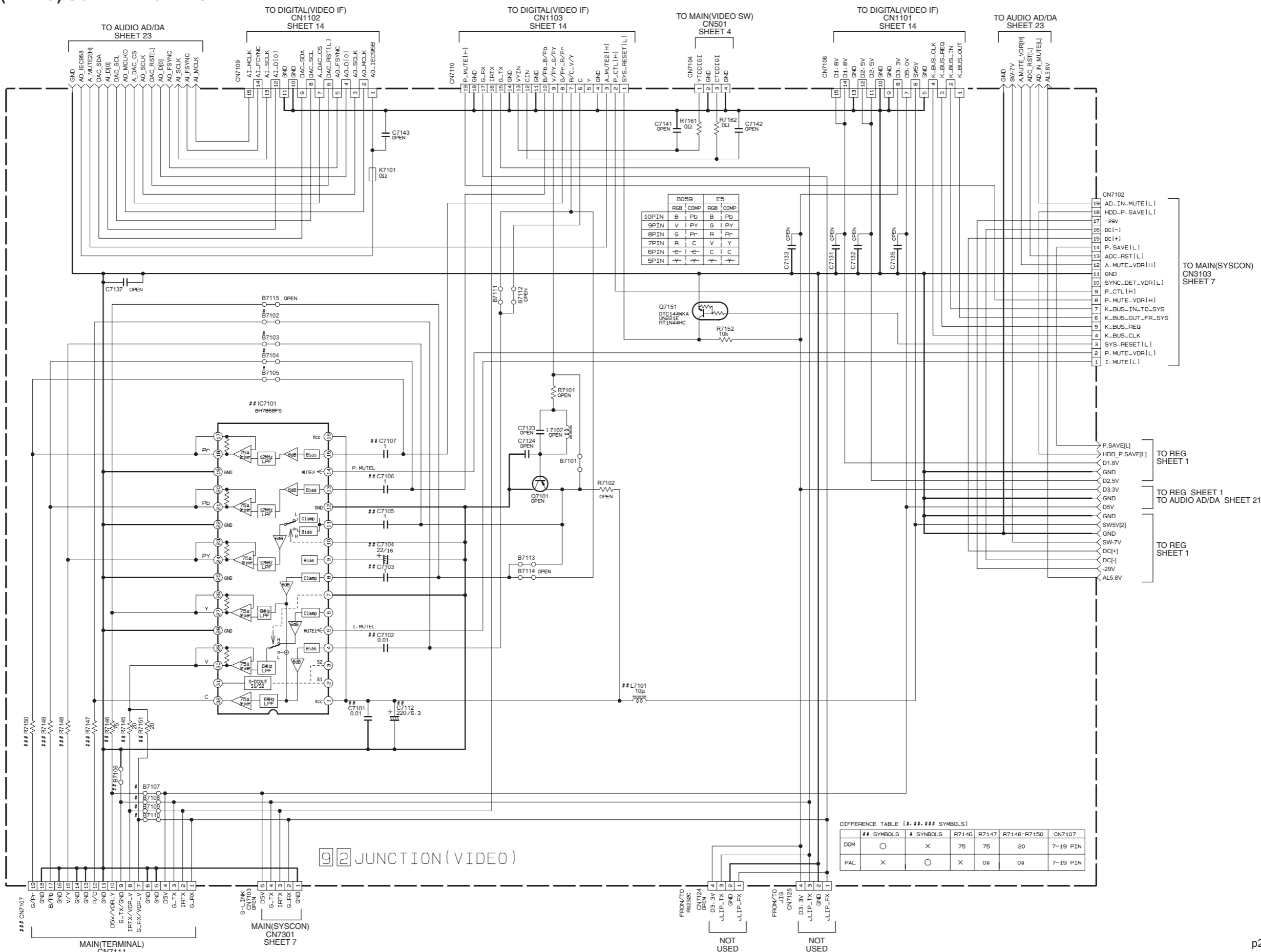

B059		E5	
RGB	COMP	RGB	COMP
10PIN	B	Pb	B
9PIN	V	PY	G
8PIN	G	Pr	R
7PIN	R	C	V
6PIN	C	C	C
5PIN	Y	Y	Y

DIFFERENCE TABLE [###.### SYMBOLS]

## SYMBOLS	# SYMBOLS	R7146	R7147	R7148-R7150	CN7107
DOM	○	X	75	75	20
PAL	X	○	X	0a	0a

92 JUNCTION(VIDEO)

# JUNCTION(AUDIO AD/DA) SCHEMATIC DIAGRAM

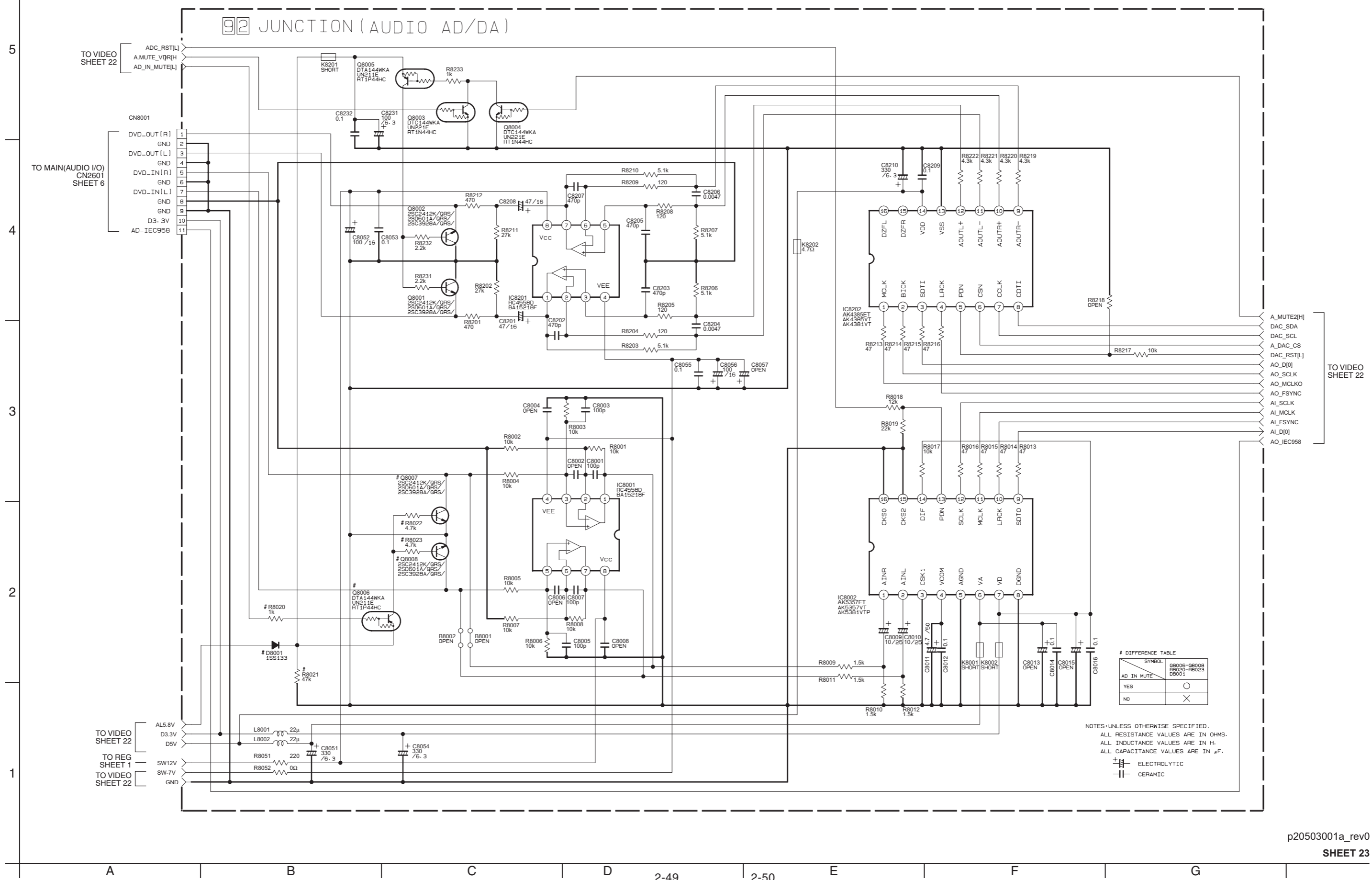

### SWITCHING REGULATOR CIRCUIT BOARD

<01>SWITCHING  
REGULATOR

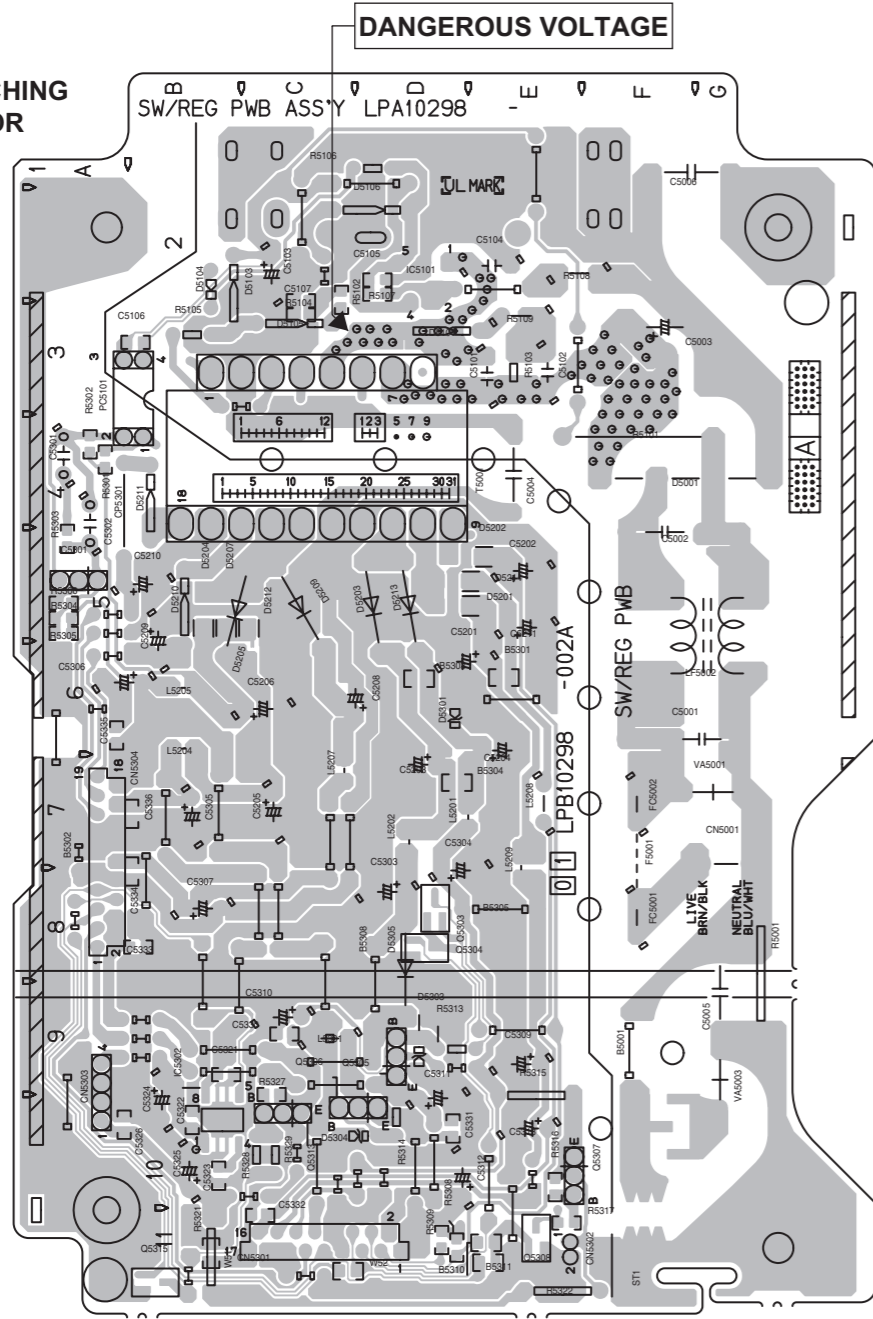

COMPONENT PARTS LOCATION GUIDE <SWITCHING REGULATOR>

REF.NO.	LOCATION	REF.NO.	LOCATION	REF.NO.	LOCATION	REF.NO.	LOCATION	REF.NO.	LOCATION	REF.NO.	LOCATION	REF.NO.	LOCATION
<b>CAPACITOR</b>	C5001 A D 6G	C5206 A D 6C	C5323 B C 10B	<b>DIODE</b>	D5301 A D 6D	L5208 A D 7E	R5104 B C 3C	R5321 A D 11B					
C5002 A D 5F	C5208 A D 5D	C5324 A D 9B	D5001 A D 4F	D5303 A D 9D	L5209 A D 7E	R5105 A D 3B	R5322 A D 11E						
C5003 A D 3F	C5210 A D 5A	C5325 A D 10B	D5101 A D 3D	D5304 A D 10C	L5301 A D 9C	R5106 A D 1D	R5327 B C 10C						
C5004 A D 4E	C5211 A D 5E	C5326 B C 10A	D5103 A D 3B	D5305 A D 8D		R5107 B C 2D	R5328 A D 10C						
C5005 A D 8G	C5301 A D 4A	C5330 B C 9C	D5104 A D 2B	<b>FUSE</b>	F5001 A D 8F	R5108 A D 2E	R5329 A D 10C						
C5006 A D 1F	C5302 A D 4A	C5332 B C 11C	D5105 A D 3C			R5109 A D 3E		<b>OTHER</b>					
C5101 A D 3E	C5303 A D 8D	C5333 B C 8B	D5201 B C 5D	<b>TRANSISTOR</b>	Q5303 B C 8D	R5109 A D 3E		CP5301 A D 4A					
C5102 A D 3E	C5304 A D 8D	C5334 B C 8B	D5202 B C 5D	Q5304 B C 8D	R5301 B C 4A	R5301 B C 4A	FC5001 A D 8F	FC5001 A D 8F					
C5103 A D 2C	C5305 A D 8D	C5335 B C 8A	D5203 B C 5A	Q5305 A D 9D	R5302 B C 4A	R5302 B C 4A	FC5002 A D 7F	FC5002 A D 7F					
C5104 A D 2E	C5306 A D 8B	C5336 B C 7B	D5204 B C 5B	Q5306 A D 10D	R5303 B C 5A	R5303 B C 5A	LF5002 A D 6F	LF5002 A D 6F					
C5105 B C 2D	C5307 A D 6B		D5205 A D 5C	Q5313 A D 10C	R5306 B C 5A	R5306 B C 5A	PC5101 A D 4B	PC5101 A D 4B					
C5106 B C 3B	C5309 A D 9E	<b>CONNECTOR</b>	D5207 B C 5B	Q5315 B C 11B	R5308 B C 11D	R5308 B C 11D	SG5001 B C 10F	SG5001 B C 10F					
C5107 B C 3C	C5310 A D 9C	CN5001 A D 7G	D5209 A D 5C		R5309 B C 11D	R5309 B C 11D	T5001 A D 3B	T5001 A D 3B					
C5201 A D 6E	C5311 A D 10D	CN5301 A D 11D	D5210 A D 6B	<b>RESISTOR</b>	R5313 A D 9D	R5313 A D 9D	VA5001 A D 7G	VA5001 A D 7G					
C5202 A D 5E	C5312 A D 10D	CN5302 A D 11E	D5211 A D 5D	R5001 A D 8G	R5314 A D 10D	R5314 A D 10D	VA5003 A D 9G	VA5003 A D 9G					
C5203 A D 7D	C5313 A D 10E	CN5303 A D 10A	D5212 B C 5C	R5101 A D 4E	R5315 A D 10E	R5315 A D 10E							
C5204 A D 6E	C5321 B C 9B	CN5304 A D 8A	D5213 A D 5D	R5102 B C 2C	R5316 B C 10E	R5316 B C 10E							
C5205 A D 7C	C5322 B C 10B		D5214 B C 5D	R5103 A D 3E	R5317 B C 11E	R5317 B C 11E							

### JUNCTION CIRCUIT BOARD

<92>JUNCTION

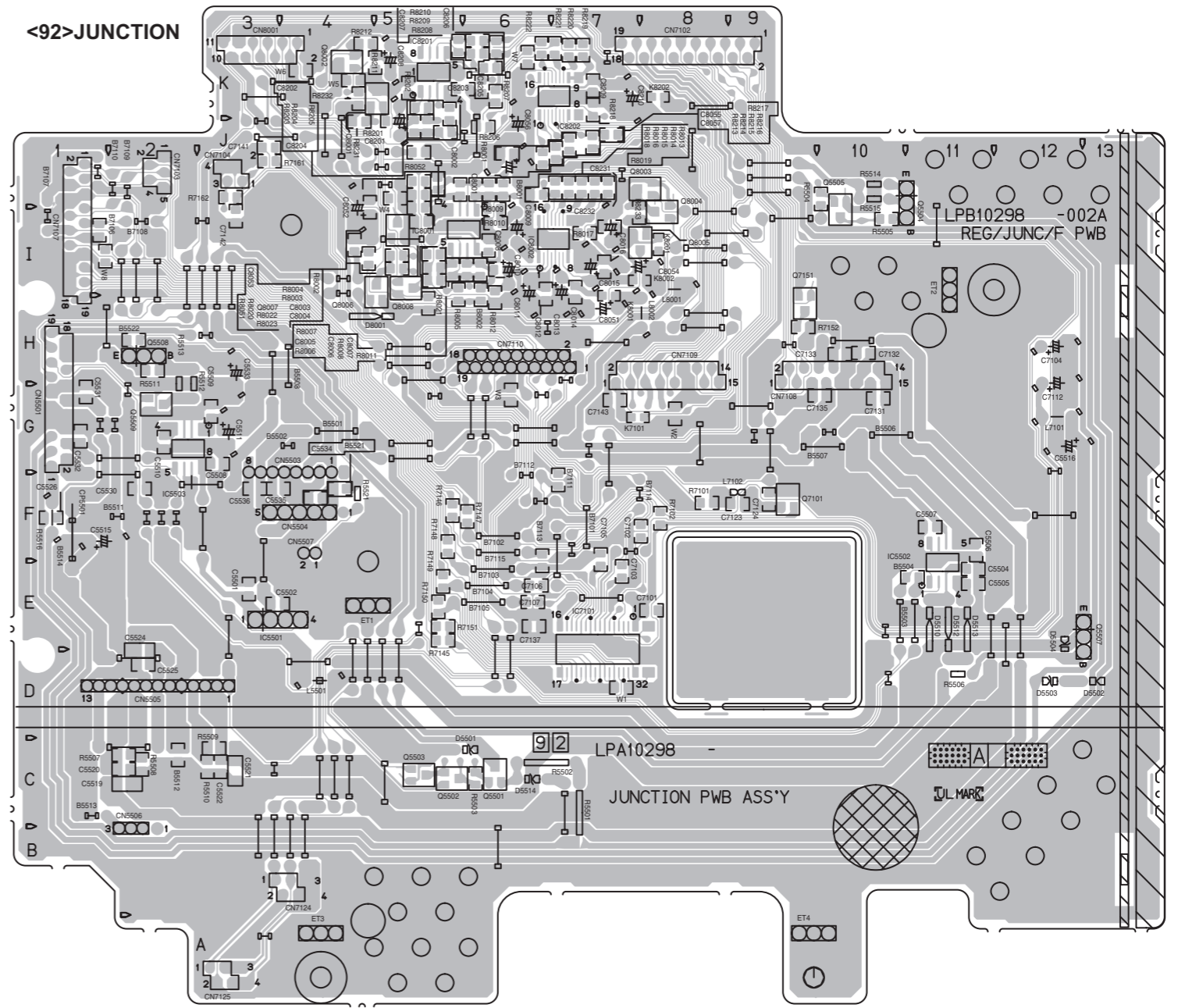

COMPONENT PARTS LOCATION GUIDE <JUNCTION>

REF.NO.	LOCATION	REF.NO.	LOCATION	REF.NO.	LOCATION	REF.NO.	LOCATION	REF.NO.	LOCATION	REF.NO.	LOCATION	REF.NO.	LOCATION	REF.NO.	LOCATION	REF.NO.	LOCATION	REF.NO.	LOCATION
<b>CAPACITOR</b>	C5501 B C 3E	C7102 B C 8E	C8010 A D 6I	<b>CONNECTOR</b>	D8001 A D 4H	Q5509 B C 2G	R5515 A D 10J	R8013 B C 7J	R8215 B C 7J										
C5502 B C 3E	C7103 B C 7E	C8011 A D 6I	CN5503 A D 1G	IC	IC5501 A D 3E	Q7101 B C 9F	R5516 A D 11F	R8014 B C 7J	R8216 B C 7J										
C5503 A D 11E	C7104 A D 12H	C8012 A D 7I	CN5504 A D 4F	Q5501 A D 3E	Q8001 B C 9H	R5521 A D 4F	R7101 B C 8F	R8015 B C 7J	R8217 B C 7J										
C5505 B C 11E	C7105 B C 7F	C8014 B C 7I	CN5505 A D 3D	IC5502 B C 11E	Q8002 B C 4K	Q8002 B C 4K	R7102 B C 8E	R8016 B C 7J	R8218 B C 7K										
C5506 B C 11F	C7106 B C 6E	C8015 A D 7I	CN5506 A D 2B	IC5503 B C 2G	Q8003 B C 8J	R7145 B C 5E	Q8003 B C 8J	R8017 B C 7I	R8219 B C 7K										
C5507 B C 11F	C7107 B C 6E	C8016 B C 7I	CN5507 A D 4F	IC7101 B C 7E	Q8004 B C 8I	R7146 B C 5F	Q8004 B C 8I	R8018 B C 7I	R8220 B C 7K										
C5508 B C 3G	C7112 A D 12H	C8051 A D 7H	CN7102 A D 9K	IC8001 B C 6I	Q8005 B C 8I	R7147 B C 6F	Q8005 B C 8I	R8019 B C 6J	R8221 B C 7K										
C5509 B C 3G	C7123 B C 9F	C8052 A D 4I	CN7103 A D 2J	IC8002 B C 7I	Q8006 B C 5I	R7148 B C 5F	Q8006 B C 5I	R8020 B C 5I	R8222 B C 6K										
C5510 B C 2G	C7124 B C 9F	C8053 A D 5J	CN7104 A D 3J	IC8201 B C 5K	Q8007 B C 5I	R7149 B C 5E	Q8007 B C 5I	R8021 B C 5H	R8223 B C 4J										
C5511 A D 3G	C7131 B C 10G	C8054 A D 8I	CN7107 A D 1J	IC8202 B C 7K	Q8008 B C 5I	R7150 B C 5E	Q8008 B C 5I	R8022 B C 5I	R8232 B C 4K										
C5515 A D 1F	C7132 B C 10H	C8055 A D 6J	CN7108 A D 9H			R7151 B C 5E		R8023 B C 5I	R8233 B C 8I										
C5516 A D 13G	C7133 B C 10H	C8056 A D 6K	CN7109 A D 7H	<b>COIL</b>	D8501 A D 4D	R7152 B C 9H		R8024 B C 5J		<b>OTHER</b>									
C5519 B C 2C	C7135 B C 10G	C8057 A D 6J	CN7110 A D 7H	LS501 A D 4D	D8502 A D 7B	R7161 B C 3J		R8025 B C 5J	CP5501 A D 1F										
C5520 B C 2C	C7137 B C 6E	C8201 A D 5J	CN7112 A D 3B	L7101 A D 12G	R5502 A D 7C	R7162 B C 3J		R8026 B C 5K	K7101 B C 8G										
C5521 B C 3C	C7141 B C 3J	C8202 A D 5K	CN7125 A D 3A	L7102 A D 9F	R5503 B C 6C	R8001 B C 6J		R8203 B C 6J	R8001 B C 7I										
C5522 B C 3C	C7142 B C 3I	C8203 B C 6K	CN8001 A D 4K	L8001 A D 8I	R5504 B C 10J	R8002 B C 5J		R8204 B C 5J	K8002 B C 8I										
C5524 B C 2E	C7143 B C 7G	C8204 B C 5J		L8002 A D 8H	R5505 A D 11D	R8003 B C 5J		R8205 B C 5K	K8201 B C 8I										
C5525 B C 2F	C8002 B C 6J	C8205 B C 6K	D5501 A D 6C	<b>DIODE</b>	D5501 A D 6C	R8004 B C 6J		R8206 B C 6J	K8202 B C 8K										
C5526 B C 2F	C8001 B C 6J	C8206 B C 6K	D5502 A D 13D	D5501 A D 6C	D5501 A D 6C	R8005 B C 6J		R8207 B C 6K											
C5530 B C 1F	C8003 B C 5J	C8207 B C 6K	D5503 A D 12D	D5502 A D 13D	D5502 A D 13D	R8006 B C 6J		R8208 B C 6K											
C5531 B C 1G	C8004 B C 5I	C8208 A D 6K	D5504 A D 12E	D5503 A D 12E	D5503 A D 12E	R8007 B C 6I		R8209 B C 6K											
C5532 B C 1G	C8005 B C 5I	C8209 A D 7K	D5504 A D 12E	D5504 A D 12E	D5504 A D 12E	R8008 B C 6I		R8210 B C 6K											
C5533 A D 3H	C8006 B C 5I	C8210 A D 7K	D5510 A D 11D	D5510 A D 11D	D5510 A D 11D	R8009 B C 6I		R8211 B C 6K											
C5534 B C 4F	C8007 B C 6I	C8211 A D 7I	D5512 A D 7I	D5512 A D 7I	D5512 A D 7I	R8010 B C 6I		R8212 B C 6K											
C5535 B C 3F	C8008 B C 6I	C8232 B C 7I	D5513 A D 11D	D5513 A D 11D	D5513 A D 11D	R8011 B C 6I		R8213 B C 6J											
C5536 B C 3F	C8009 A D 6I		D5514 A D 7C	D5514 A D 7C	D5514 A D 7C	R8012 B C 6H		R8214 B C 7J											

MAIN CIRCUIT BOARD

<03>MAIN

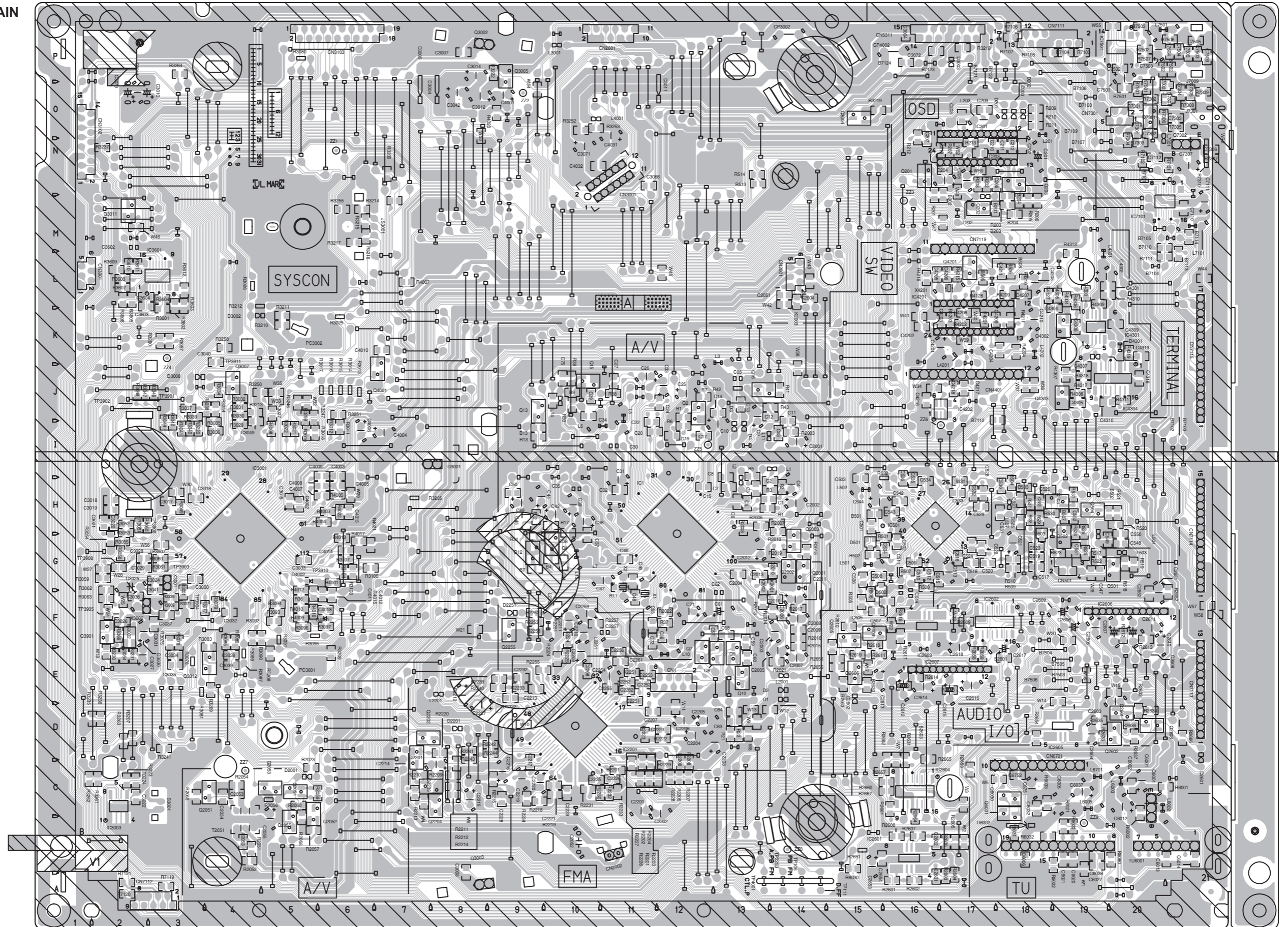



■ OPERATION/JACK,SWITCH/DISPLAY, AND DV JACK CIRCUIT BOARDS

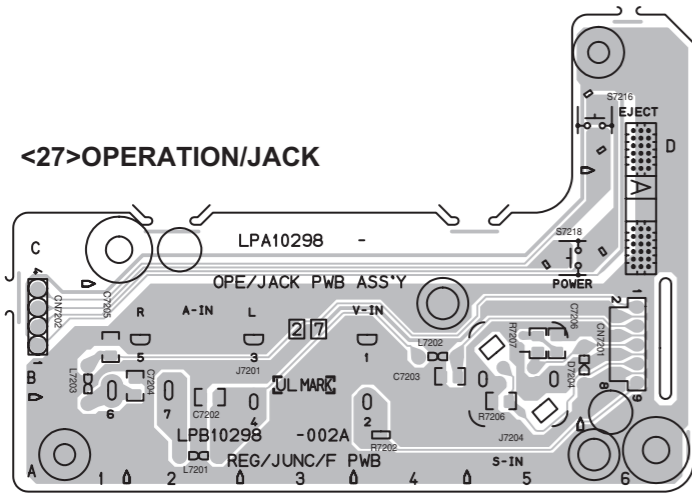

COMPONENT PARTS LOCATION GUIDE <OPERATION/JACK>

REF.NO.	LOCATION	REF.NO.	LOCATION	REF.NO.	LOCATION	REF.NO.	LOCATION	REF.NO.	LOCATION
<b>CAPACITOR</b>		<b>CONNECTOR</b>		<b>COIL</b>		<b>RESISTOR</b>		<b>OTHER</b>	
C7202	B C 2A	CN7201	A D 6B	L7201	A D 2A	R7202	A D 4A	J7201	A D 3B
C7203	B C 4B	CN7202	A D 1B	L7202	A D 4B	R7206	B C 5A	J7204	A D 5B
C7204	B C 2A			L7203	A D 1B	R7207	B C 5B	S7216	A D 6D
C7205	B C 1B							S7218	A D 5C
C7206	B C 5B								

<36>DV JACK

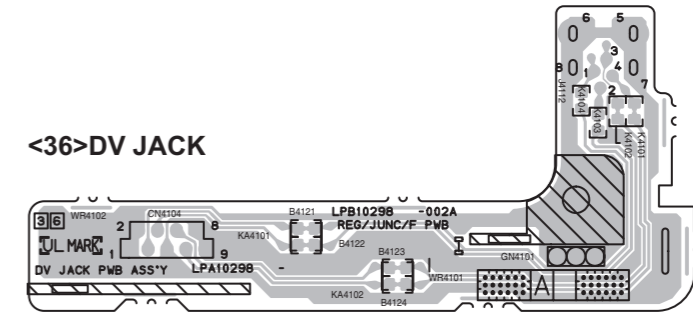

<28>SWITCH/DISPLAY

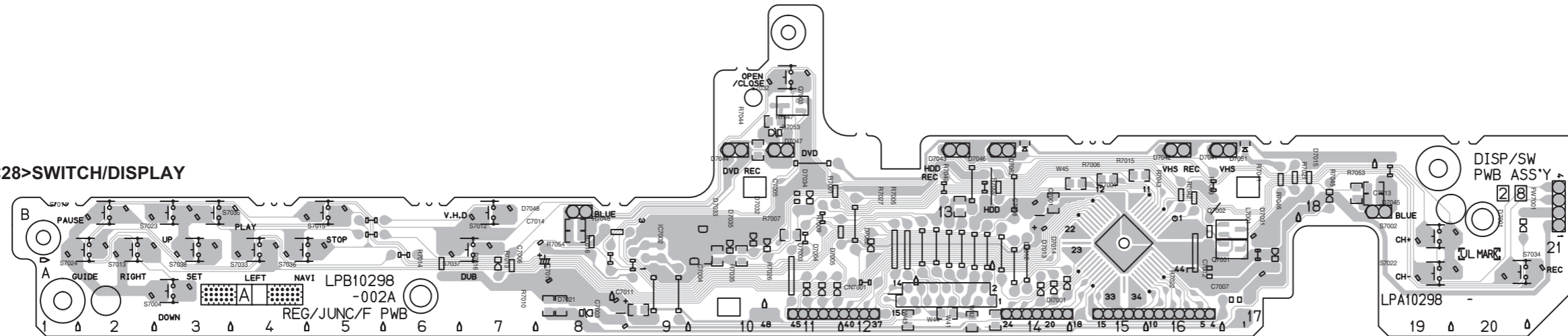

COMPONENT PARTS LOCATION GUIDE <SWITCH/DISPLAY>

REF.NO.	LOCATION	REF.NO.	LOCATION	REF.NO.	LOCATION	REF.NO.	LOCATION	REF.NO.	LOCATION
<b>CAPACITOR</b>		<b>CONNECTOR</b>		<b>DIODE</b>		<b>RESISTOR</b>		<b>OTHER</b>	
C7001	B C 14B	CN7001	A D 13A	D7015	A D 18B	R7001	A D 11C	R7042	A D 16B
C7002	A D 16A			D7016	A D 7A	R7002	A D 14C	R7043	A D 16B
C7003	A D 9A			D7017	A D 17B	R7003	A D 16B	R7044	B C 10C
C7004	B C 10B			D7018	A D 18B	R7004	A D 16B	R7045	B C 18B
C7005	A D 11B			D7019	A D 19B	R7005	A D 16B	R7046	A D 17B
C7006	A D 8B			D7020	A D 20B	R7006	B C 14C	R7047	B C 11C
C7007	A D 17A			D7021	A D 21B	R7007	B C 17B	R7048	A D 9B
C7008	A D 14B			D7022	A D 22B	R7008	B C 17B	R7049	A D 9B
C7009	A D 14B			D7023	A D 10B	R7009	A D 12B	R7050	B C 13B
C7010	B C 8A			D7024	A D 10B	R7010	B C 17B	R7051	B C 18B
C7011	B C 9A			D7025	A D 11B	R7011	A D 12B	R7052	B C 18B
C7012	B C 18B			D7026	A D 12B	R7012	A D 12B	R7053	B C 18B
C7013	B C 8B			D7027	A D 13B	R7013	A D 12B	R7054	B C 8B
C7014	B C 8B			D7028	A D 14B	R7014	A D 12B	R7055	B C 8B
				D7029	A D 15B	R7015	B C 15C	R7056	B C 8B
				D7030	A D 16B	R7016	A D 8B	R7057	B C 18B
				D7031	A D 17B	R7017	A D 18B	R7058	B C 18B
				D7032	A D 18B	R7018	A D 19B	R7059	B C 18B
				D7033	A D 19B	R7019	A D 20B	R7060	B C 18B
				D7034	A D 20B	R7020	A D 21B	R7061	B C 18B
				D7035	A D 21B	R7021	A D 22B	R7062	B C 18B
				D7036	A D 22B	R7022	A D 23B	R7063	B C 18B
				D7037	A D 23B	R7023	A D 24B	R7064	B C 18B
				D7038	A D 24B	R7024	A D 25B	R7065	B C 18B
				D7039	A D 25B	R7025	A D 26B	R7066	B C 18B
				D7040	A D 26B	R7026	A D 27B	R7067	B C 18B
				D7041	A D 27B	R7027	A D 28B	R7068	B C 18B
				D7042	A D 28B	R7028	A D 29B	R7069	B C 18B
				D7043	A D 29B	R7029	A D 30B	R7070	B C 18B
				D7044	A D 30B	R7030	A D 31B	R7071	B C 18B
				D7045	A D 31B	R7031	A D 32B	R7072	B C 18B
						R7032	A D 33B	R7073	B C 18B
						R7033	A D 34B	R7074	B C 18B
						R7034	A D 35B	R7075	B C 18B
						R7035	A D 36B	R7076	B C 18B
						R7036	A D 37B	R7077	B C 18B
						R7037	A D 38B	R7078	B C 18B
						R7038	A D 39B	R7079	B C 18B
						R7039	A D 40B	R7080	B C 18B
						R7040	A D 41B	R7081	B C 18B
						R7041	A D 42B	R7082	B C 18B
						R7042	A D 43B	R7083	B C 18B
						R7043	A D 44B	R7084	B C 18B
						R7044	A D 45B	R7085	B C 18B
						R7045	A D 46B	R7086	B C 18B
						R7046	A D 47B	R7087	B C 18B
						R7047	A D 48B	R7088	B C 18B
						R7048	A D 49B	R7089	B C 18B
						R7049	A D 50B	R7090	B C 18B
						R7050	A D 51B	R7091	B C 18B
						R7051	A D 52B	R7092	B C 18B
						R7052	A D 53B	R7093	B C 18B
						R7053	A D 54B	R7094	B C 18B
						R7054	A D 55B	R7095	B C 18B
						R7055	A D 56B	R7096	B C 18B
						R7056	A D 57B	R7097	B C 18B
						R7057	A D 58B	R7098	B C 18B
						R7058	A D 59B	R7099	B C 18B
						R7059	A D 60B	R7100	B C 18B

■ DC/DC CONV, SECAM AND TERMINAL CIRCUIT BOARDS

<11>DC/DC CONV

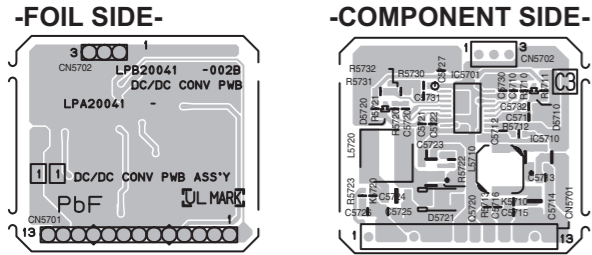

<88>SECAM

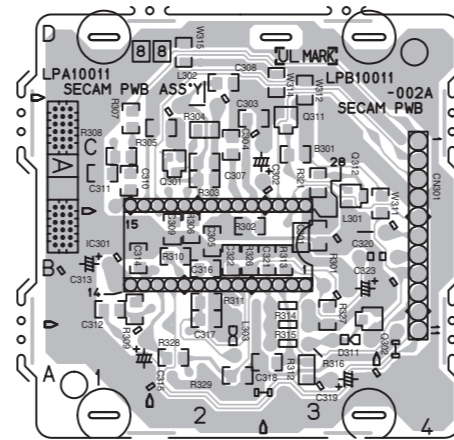

COMPONENT PARTS LOCATION GUIDE <SECAM>

REF.NO.	LOCATION	REF.NO.	LOCATION	REF.NO.	LOCATION	REF.NO.	LOCATION	REF.NO.	LOCATION	
<b>CAPACITOR</b>					<b>COIL</b>					
C301	B C 3B	C317	B C 2A	R304	B C 2C	R328	B C 2A			
C302	A D 2C	C318	B C 2A	R305	B C 1C	R329	B C 2A			
C303	B C 2C	C319	A D 3A	R306	B C 2B					
C304	B C 2C	C320	A D 4B	L301	A D 3B	R307	B C 1C			
C305	B C 2B	C321	B C 2B	L302	A D 2C	R308	B C 1C			
C307	B C 2C	C322	B C 2B	L303	A D 2A	R309	B C 1B			
C308	B C 2D	C323	A D 3B	<b>TRANSISTOR</b>						
C309	B C 2B			Q301	B C 2C	R310	B C 2B			
C310	B C 1C	<b>CONNECTOR</b>			Q302	B C 3A	R312	B C 3A		
C311	B C 1C	CN301	A D 4C	Q311	B C 3C	R313	B C 3B			
C312	B C 1B	<b>DIODE</b>			Q312	B C 3C	R314	A D 3B		
C313	A D 1B	D311	A D 3A	<b>RESISTOR</b>						
C314	B C 1B			R301	B C 3B	R321	B C 3C			
C315	A D 1A	<b>IC</b>			R302	B C 2B	R326	B C 2B		
C316	B C 2B	IC301	A D 3B	R303	B C 2C	R327	B C 3A			

<06>TERMINAL

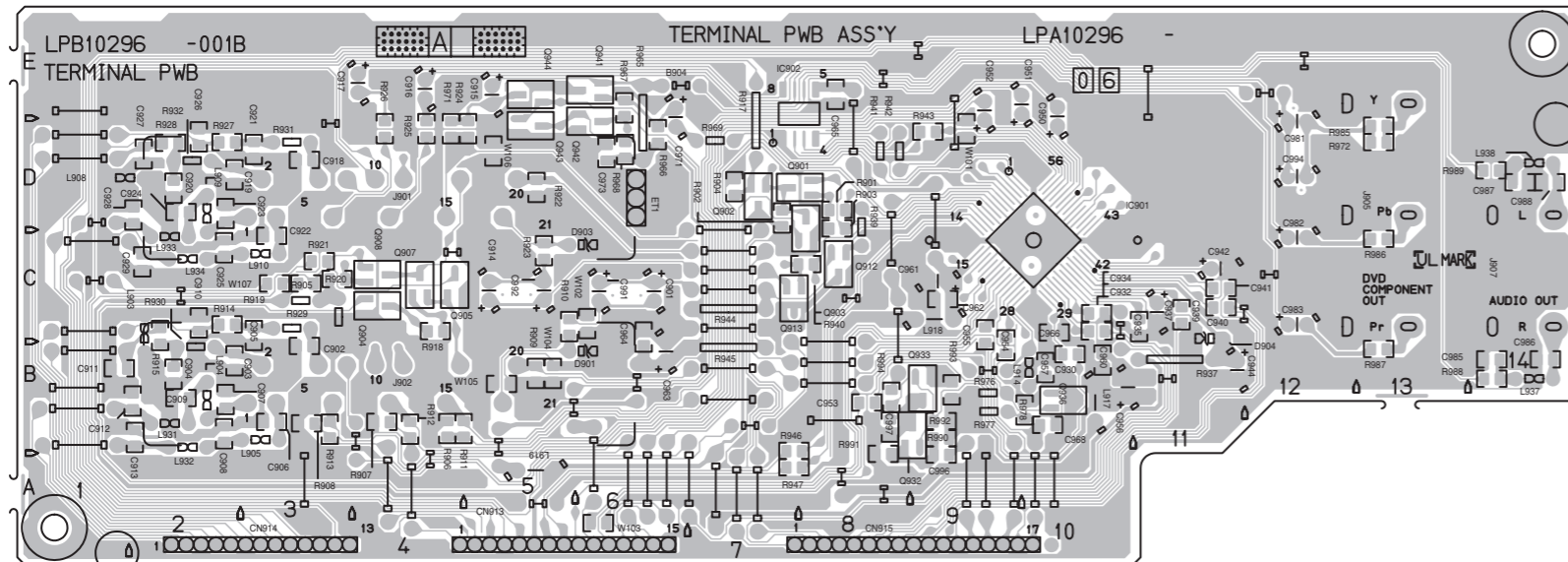

COMPONENT PARTS LOCATION GUIDE <TERMINAL>

REF.NO.	LOCATION	REF.NO.	LOCATION	REF.NO.	LOCATION	REF.NO.	LOCATION	REF.NO.	LOCATION	REF.NO.	LOCATION	REF.NO.	LOCATION	
<b>CAPACITOR</b>												<b>COIL</b>		
C901	A D 6C	C928	B C 2D	C971	A D 6E	Q913	B C 7C	R919	A D 3C	R969	A D 7D			
C902	B C 3B	C929	B C 2C	C973	B C 6D	Q932	B C 9B	R920	B C 3C	R971	B C 4D			
C903	B C 2B	C930	B C 10B	C981	A D 12D	L903	A D 2B	Q933	B C 9B	R921	B C 3C	R972	B C 13D	
C904	B C 2B	C932	B C 10C	C982	A D 12C	L904	A D 2B	Q936	B C 10B	R922	B C 5D	R976	A D 9B	
C905	B C 3C	C934	B C 10C	C983	A D 12C	L905	A D 3B	Q941	B C 6E	R923	B C 5C	R977	A D 9B	
C906	B C 3B	C935	B C 11C	C985	B C 14B	L908	A D 2D	Q942	B C 6D	R924	B C 5D	R978	B C 10B	
C907	B C 2B	C937	A D 11C	C986	B C 14B	L909	A D 2C	Q943	B C 5D	R925	B C 4D	R985	B C 13D	
C908	B C 2B	C939	B C 11C	C987	B C 14D	L910	A D 3C	Q944	B C 5E	R926	B C 4D	R986	B C 13C	
C909	B C 2B	C940	B C 11C	C988	B C 14D	L914	A D 10B			R927	B C 2D	R987	B C 13B	
C910	B C 2C	C941	B C 11C	C991	A D 6C	L917	A D 10B	<b>RESISTOR</b>						
C911	B C 1B	C942	A D 11C	C992	A D 5C	L918	A D 9C	R901	B C 8D	R928	B C 2D	R988	B C 14B	
C912	B C 2B	C944	A D 11B	C994	A D 12D	L919	A D 5A	R902	B C 7D	R929	A D 3C	R989	B C 14D	
C913	B C 2B	C950	A D 10D	C996	B C 9A	L931	A D 2B	R903	B C 8D	R930	A D 2B	R990	B C 9B	
C914	A D 5C	C951	A D 10E	C997	B C 8B	L932	A D 2B	R904	B C 8D	R931	A D 3D	R991	B C 8A	
C915	A D 5E	C952	A D 9D			L933	A D 2C	R905	B C 3C	R932	A D 2D	R992	B C 9B	
C916	A D 4E	C953	B C 8B	<b>CONNECTOR</b>			L934	A D 2C	R906	B C 4B	R937	A D 11B	R993	B C 9B
C917	A D 4E	C954	B C 9B	CN913	A D 4A	L937	A D 14B	R907	B C 4B	R939	A D 8D	R994	B C 8B	
C918	B C 3D	C955	B C 9C	CN914	A D 2A	L938	A D 14D	R908	B C 3B	R941	A D 8D	<b>OTHER</b>		
C919	B C 2D	C956	A D 10B	CN915	A D 7A			R909	B C 5B	R942	A D 8D	J901	A D 4D	
C920	B C 2D	C957	B C 10B	<b>DIODE</b>			Q901	B C 8D	R910	B C 5C	R943	B C 9D	J902	A D 4B
C921	B C 3D	C961	A D 9C	D901	A D 6B	Q902	B C 7D	R911	B C 5B	R944	A D 7C	J905	A D 13D	
C922	B C 3C	C962	B C 9C	D903	A D 6C	Q903	B C 8D	R912	B C 4B	R945	A D 7B	J907	A D 14C	
C923	B C 2D	C963	A D 6B	D904	A D 11C	Q904	B C 4C	R913	B C 3B	R946	B C 7B			
C924	B C 2D	C964	B C 6C			Q905	B C 4C	R914	B C 2C	R947	B C 7A			
C925	B C 2C	C965	B C 8E	<b>IC</b>			Q907	B C 4C	R915	B C 2C	R965	A D 6D		
C926	B C 2D	C966	B C 10C	IC901	B C 10C	Q908	B C 4C	R916	A D 3C	R966	B C 6D			
C927	B C 2D	C968	B C 10B	IC902	B C 8E	Q912	B C 8C	R917	A D 7D	R967	B C 6E			





■ DEMOD CIRCUIT BOARD

■ RGB YC CIRCUIT BOARD

<14>DEMOM

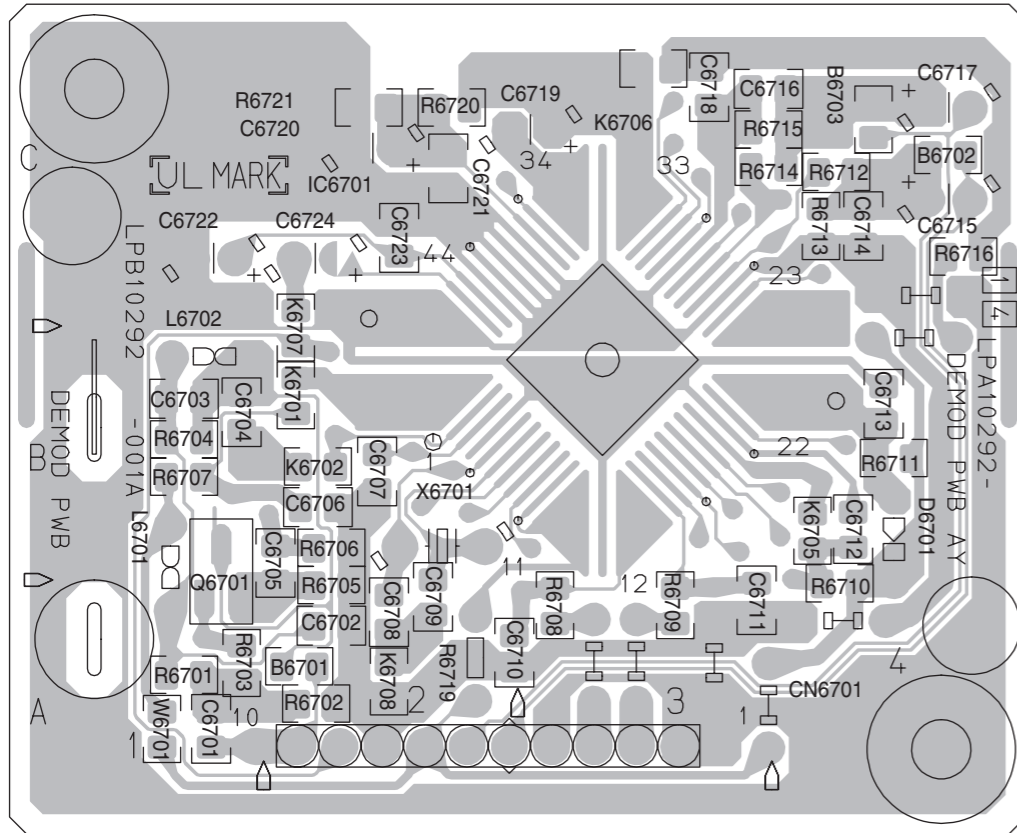

<68>RGB YC

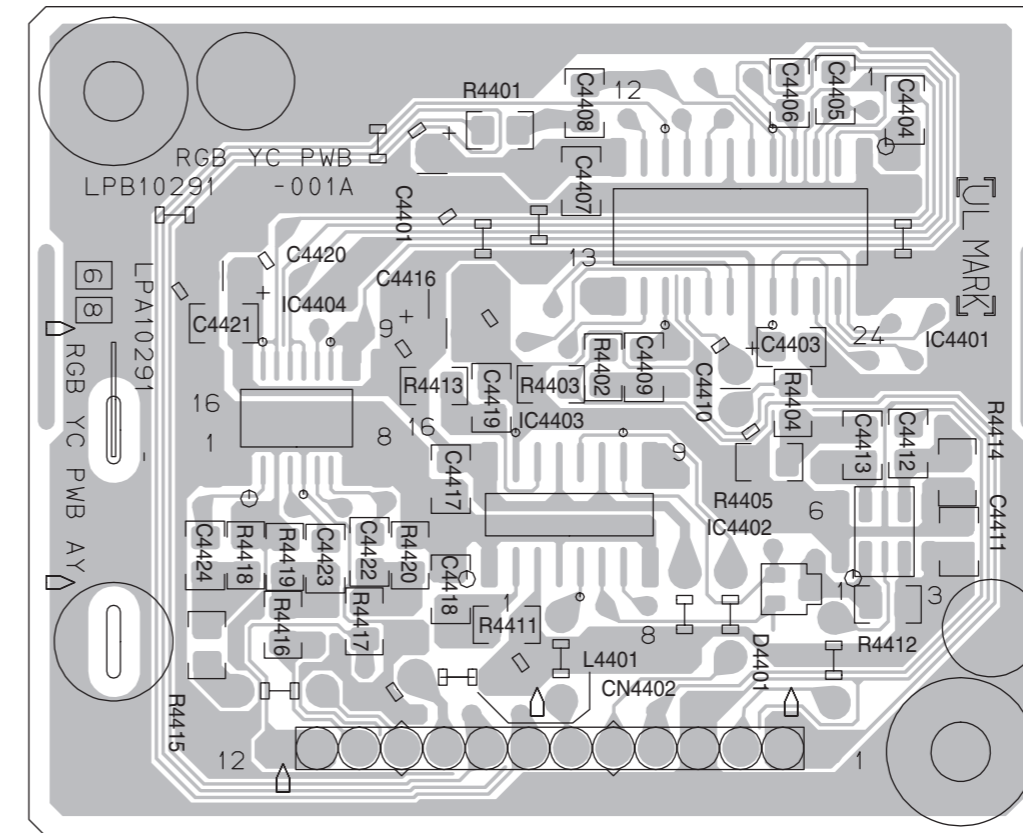

COMPONENT PARTS LOCATION GUIDE <DEMOM>

REF.NO.	LOCATION	REF.NO.	LOCATION	REF.NO.	LOCATION	REF.NO.	LOCATION	REF.NO.	LOCATION
<b>CAPACITOR</b>									
C6701	B C 1A	C6715	A D 4C	D6701	A D 4B	R6703	B C 1A	R6720	B C 2C
C6702	B C 2A	C6716	B C 3C			R6704	B C 1B	R6721	B C 2C
C6703	B C 1B	C6717	A D 4C	<b>IC</b>		R6705	B C 2A		
C6704	B C 1B	C6718	B C 3C	IC6701	B C 3B	R6706	B C 2B	<b>OTHER</b>	
C6705	B C 2B	C6719	A D 3C			R6707	B C 1B	K6701	B C 2B
C6706	B C 2B	C6720	A D 2C	<b>COIL</b>		R6708	B C 3A	K6702	B C 2B
C6707	B C 2B	C6721	B C 2C	L6701	A D 1A	R6709	B C 3A	K6705	B C 4B
C6708	B C 2A	C6722	A D 1C	L6702	A D 1B	R6710	B C 4A	K6706	B C 3D
C6709	B C 2A	C6723	B C 2C			R6711	B C 4B	K6707	B C 2B
C6710	B C 2A	C6724	A D 2C	<b>TRANSISTOR</b>		R6712	B C 4C	K6708	B C 2A
C6711	B C 3A			Q6701	B C 1B	R6713	B C 4C	X6701	A D 2B
C6712	B C 4B	<b>CONNECTOR</b>				R6714	B C 3C		
C6713	B C 4B	CN6701	A D 3A	<b>RESISTOR</b>		R6715	B C 3C		
C6714	B C 4C			R6701	B C 1A	R6716	B C 4C		
				R6702	B C 2A	R6719	A D 2A		

COMPONENT PARTS LOCATION GUIDE <RGB YC>

REF.NO.	LOCATION	REF.NO.	LOCATION	REF.NO.	LOCATION	REF.NO.	LOCATION	REF.NO.	LOCATION
<b>CAPACITOR</b>									
C4401	A D 2C	C4413	B C 4B	CN4402	A D 3A	L4401	A D 2A	R4415	B C 1A
C4403	B C 4B	C4416	A D 2B					R4416	B C 2A
C4404	B C 4C	C4417	B C 2B	<b>DIODE</b>		D4401	B C 4A	R4417	B C 2A
C4405	B C 4C	C4418	B C 2A			R4401	B C 2C	R4418	B C 1B
C4406	B C 3C	C4419	B C 2B	<b>RESISTOR</b>		R4402	B C 3B	R4419	B C 2B
C4407	B C 3C	C4420	A D 1C	<b>IC</b>		R4403	B C 3B	R4420	B C 2B
C4408	B C 3C	C4421	B C 1C	IC4401	B C 3C	R4404	B C 4B		
C4409	B C 3B	C4422	B C 2B	IC4402	B C 4B	R4405	B C 3B		
C4410	A D 3B	C4423	B C 2B	IC4403	B C 3B	R4411	B C 2A		
C4411	B C 4B	C4424	B C 1B	IC4404	B C 2B	R4412	B C 4A		
C4412	B C 4B					R4413	B C 2B		
		<b>CONNECTOR</b>		<b>COIL</b>		R4414	B C 4B		

**DIGITAL BLOCK DIAGRAM**

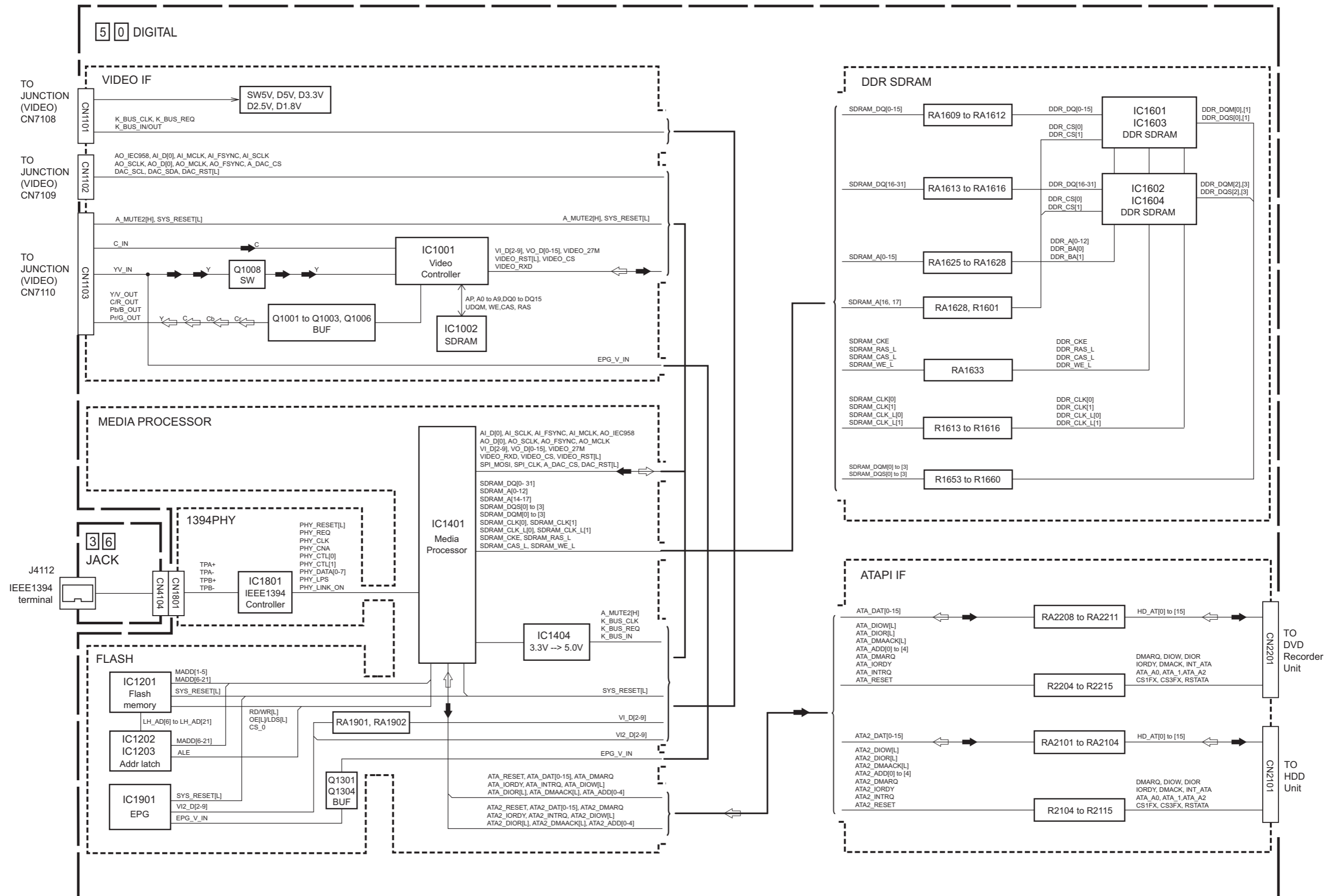

VIDEO BLOCK DIAGRAM (1)

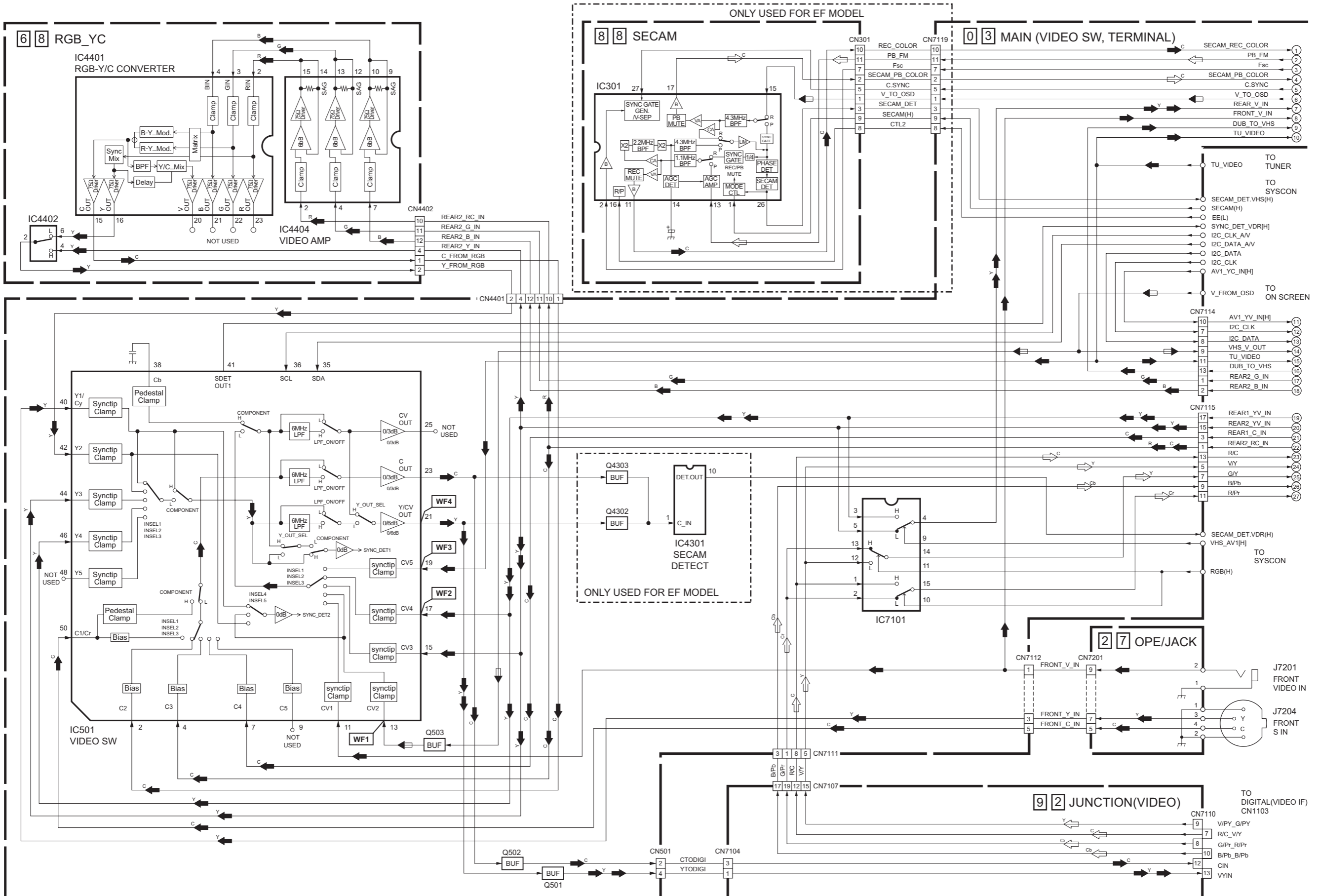

VIDEO BLOCK DIAGRAM (2)

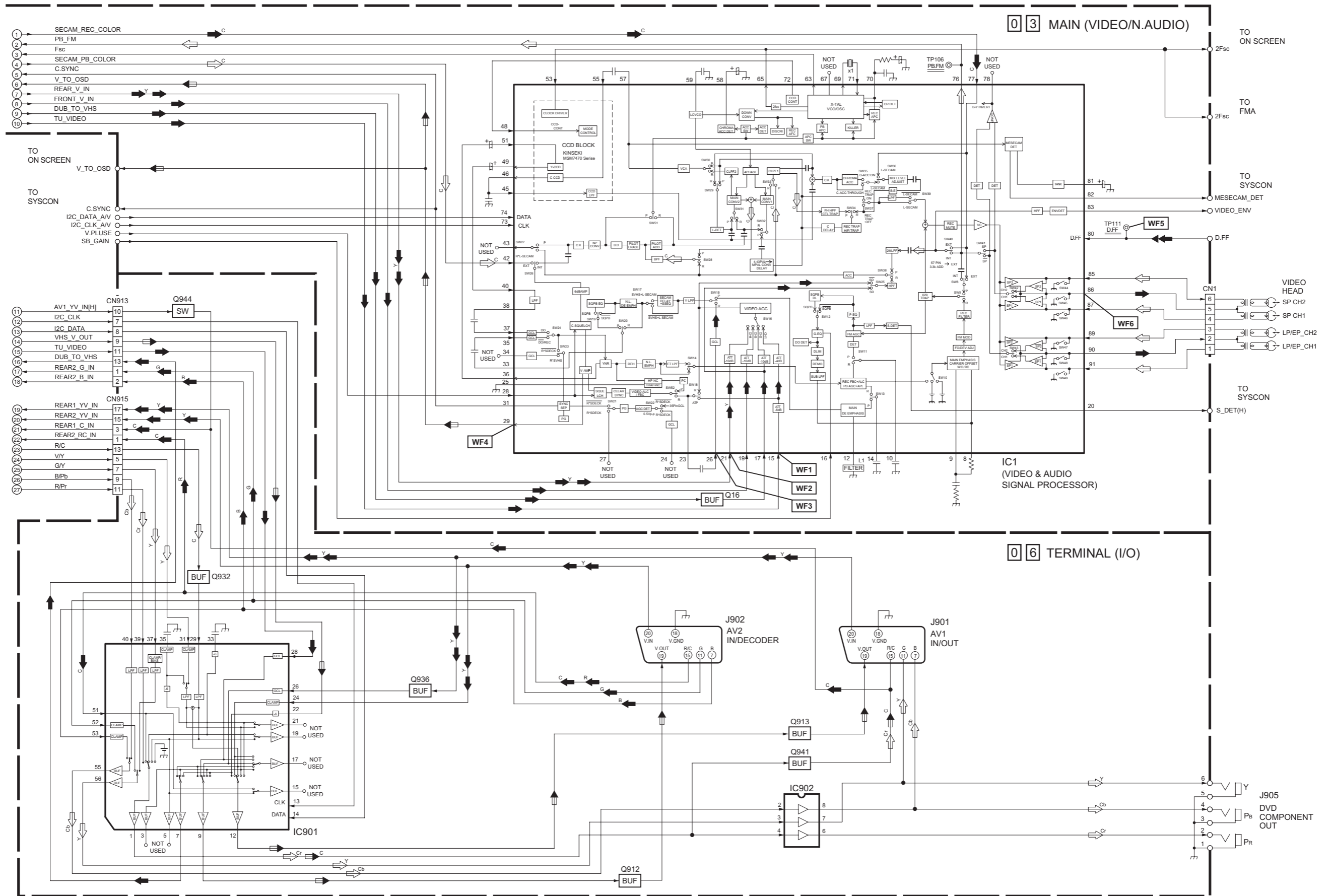

# AUDIO BLOCK DIAGRAM

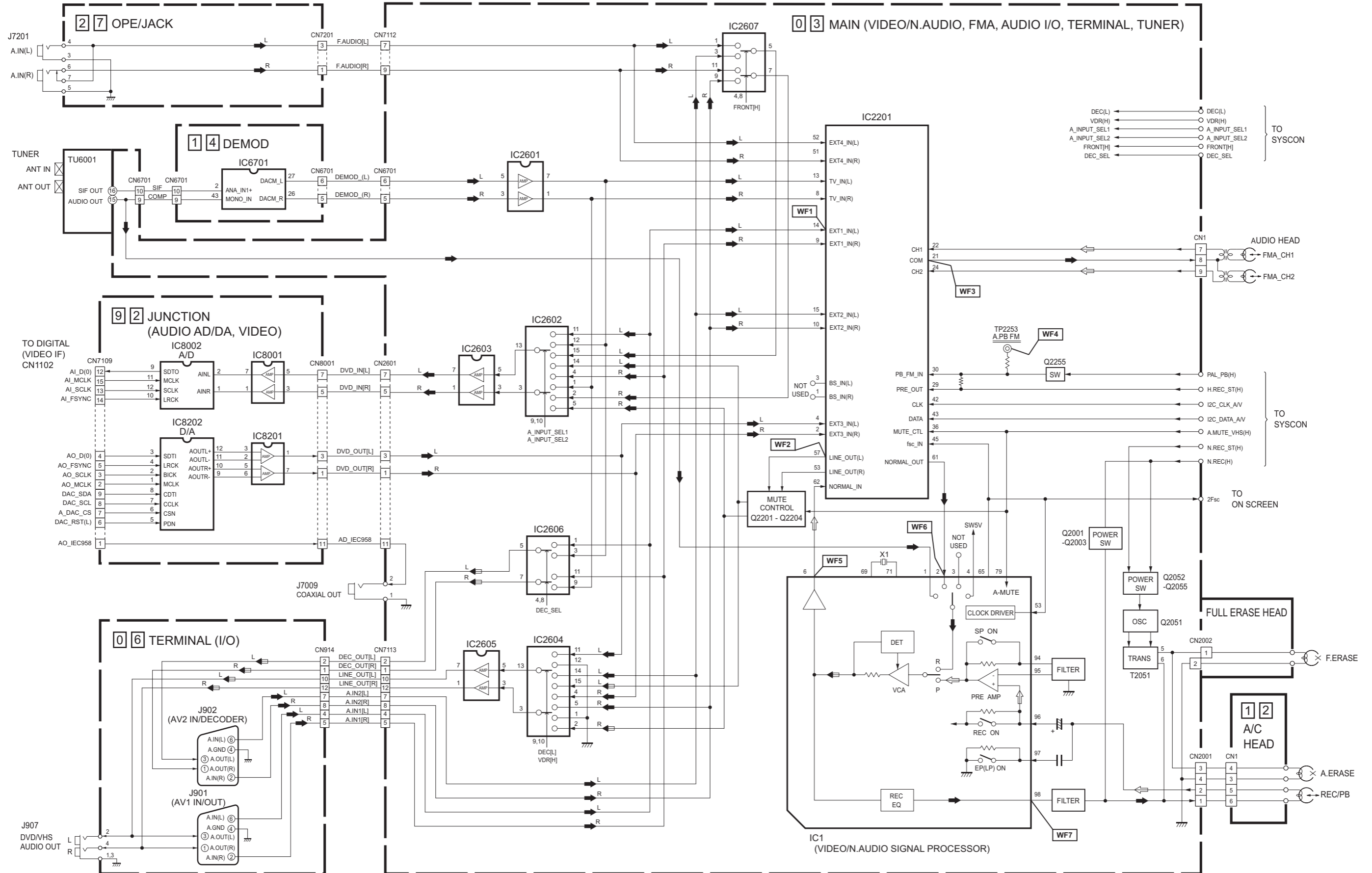

# SYSTEM CONTROL BLOCK DIAGRAM

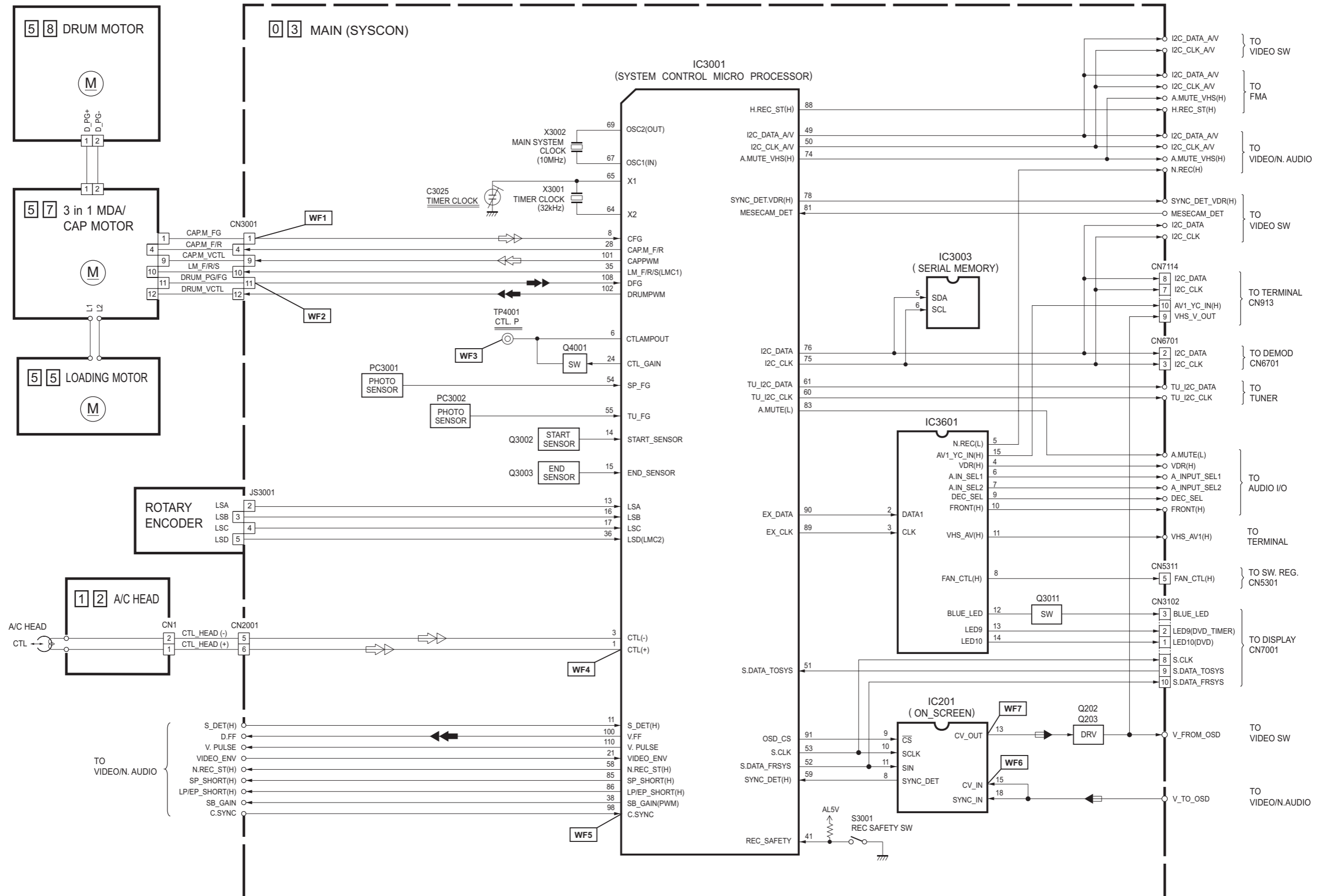

## CPU PIN FUNCTION

### <SYSCON IC3001>

PIN NO.	LABEL	IN/OUT	FUNCTION
1	CTL[+]	IN/OUT	CTL(+) SIGNAL
2	SVss	-	GND
3	CTL[-]	IN/OUT	CTL(-) SIGNAL
4	CTLBIAS	-	CTL BIAS VOLTAGE
5	CTLFB	IN	CTL PULSE FEEDBACK
6	CTLAMPOUT	OUT	CTL PULSE OUTPUT
7	CTLSMTIN	IN	CTL PULSE OUTPUT
8	CFG	IN	CAPSTAN FG PULSE INPUT
9	SVcc	-	SYSTEM POWER
10	Avcc	-	SYSTEM POWER
11	S_DET[H]	IN	NORMAL-H
12	SECAN_DET	IN	SECAN MODE DETECT
13	LSA	IN	MECHANISM MODE DETECT (A)
14	START_SENSOR	IN	START SENSOR
15	END_SENSOR	IN	END SENSOR
16	LSB	IN	MECHANISM MODE DETECT (B)
17	LSC	IN	MECHANISM MODE DETECT(C)
18	RF AGC	IN	CHANGES IN AT5+IC OUTPUT AS CAUSED BY CHANGES IN RECEIVER SENSITIVITY WHEN THE SAME CHANNEL IS RECEIVED MORE ARE INPUT.
19	SCR_ID	IN	SCRAMBLE CONTROL INPUT (SCRAMBLE : H)
20	AFC	IN	TUNING CHECK
21	VIDEO_ENV	IN	AUTO TRACKING DETECT/INPUT THE AVERAGE OF PLAYBACK VIDEO SIGNAL
22	A.ENV/ND[L]	IN	AUDIO PB FM ENV. INPUT/NON HIFI MODE:L
23	Avss	-	GND
24	CTL_GAIN	OUT	CONTROL AMP OUT FREQUENCY RESPONSE SWITCHIN
25	A.MUTE_VDR[H]	OUT	AUDIO MUTE CONTROL FOR VDR(MUTE:H)
26	P.MUTE_VDR[H]	OUT	PICTURE MUTE CONTROL FOR VDR(MUTE:H)
27	SECAM_DET_VDR[H]	IN	SECAM MODE DETECT CONTROL FOR VDR
28	CAP_M_F/R	OUT	CAPSTAN MOTOR REVERSE CONTROL (FWD:L/REV:H)
29	RC_IN	IN	REMOTE CONTROL DATA INPUT
30	PROTECT	IN	DETECTION SIGNAL FOR SWITCHING POWERSUPPLY
31	P50_IN	IN	CONTROL SIGNAL FOR TV LINK
32	TEST	-	CONNECTED TO GND
33	P.MUTE_VDR[L]	OUT	PICTURE MUTE CONTROL FOR VDR(MUTE:L)
34	P50_OUT	OUT	CONTROL SIGNAL FOR TV LINK
35	LM_F/R/S[LMC1]	OUT	LOADING MOTOR DRIVE
36	LSD[LMC2]	IN	MECHANISM MODE DETECT (D)
37	RGB[H]	OUT	RGB MODE : H
38	SB_GAIN[PWM]	OUT	VOLTAGE CONTROL SIGNAL FOR VIDEO FREQUENCY RESPONSE
39	STB/TEST	OUT	CLOCK OUTPUT PERMISSION
40	POWER_DET	IN	DETECTION SIGNAL FOR POWER DOWN OF AC POWER SUPPLY
41	REC_SAFETY	IN	REC SAFETY SWITCH DETECT (SW ON:L)
42	HDD_P_CTL[H]	-	NOT USED
43	Vss	-	GND
44	DVD_P_CTL[H]	OUT	DVD POWER ON/OFF CONTRPL (POWER ON:H)
45	Vcc	-	SYSTEM POWER
46	KBUS_DATA_IN	IN	SERIAL DATA TRANSFER INPUT FROM DVD CPU
47	KBUS_DATA_OUT	OUT	SERIAL DATA TRANSFER OUTPUT TO DVD CPU
48	KBUS_CLK	OUT	SERIAL DATA TRANSFERMER CLOCK FOR DVD CPU
49	I2C_DATA_AV	IN/OUT	SERIAL DATA TRANSFER OUTPUT FOR A/V IC
50	I2C_CLK_AV	OUT	SERIAL DATA TRANSFER CLOCK FOR A/V IC
51	S.DATA_TOSYS	IN	SERIAL DATA TRANSFER OUTPUT FROM THE ON-SCREEN TO THE FDP DRIVER
52	S.DATA_FRSYS	OUT	SERIAL DATA TRANSFER OUTPUT FROM THE FDP DRIVER TO THE ON-SCREEN
53	S.CLK	OUT	SERIAL DATA TRANSFERMER CLOCKFOR ONSCREEN IC
54	SP_FG	IN	DETECTION SIGNAL FOR SUPPLY REEL ROTATION/TAPE REMAIN
55	TU_FG	IN	DETECTION SIGNAL TAKE-UP REEL ROTATION/TAPE REMAIN
56	KBUS_REQ[IN]	OUT	SERIAL DATA TRANSFER REQUEST TO DVD CPU

PIN NO.	LABEL	IN/OUT	FUNCTION
57	P.ON_PULSE	OUT	POWER ON/OFF PULSE OUTPUT
58	N.REC_ST[H]	OUT	NORMAL AUDIO SOUND RECORDINGSTART
59	SYNC_DET[H]	IN	DETECTION OF VIDEO SYNC SIGNAL (DETECTED : H)
60	TU_I2C_CLK	OUT	CLOCK OUTPUT TO TUNER
61	TU_I2C_DATA	OUT	DATA OUT PUT TO TUNER
62	FWE	-	FLASH WRITE ENABLE
63	NMI	-	NOT USED
64	X2	-	TIMER CLOCK(32kHz)
65	X1	-	TIMER CLOCK(32kHz)
66	RES	-	RESET TERMINAL(RESET ON:L)
67	OSC1[IN]	IN	MAIN SYSTEM CLOCK(10MHz)
68	Vss	-	GND
69	OSC2[OUT]	IN	MAIN SYSTEM CLOCK(10MHz)
70	Vcc	-	SYSTEM POWER
71	MODE	-	NOT USED
72	AD_IN_MUTE[L]	OUT	MUTE CONTROL SIGNAL TO A/D CONVERTER IC
73	TU_V.MUTE[H]	OUT	TUNER VIDEO SIGNAL MUTE : H
74	A.MUTE_VHS[H]	OUT	AUDIO MUTE CONTROL FOR VHS(MUTE:H)
75	I2C_CLK	OUT	SERIAL DATA TRANSFER CLOCK FOR MEMORY IC
76	I2C_DATA	IN/OUT	SERIAL DATA TRANSFER OUTPUT FOR MEMORY IC
77	SECAN[H]	IN	SECAN MODE :H
78	SYNC_DET_VDR[H]	IN	DETECTION OF VIDEO SYNC SIGNAL FOR VDR (DETECTED : H)
79	PAL_PB[H]	IN	PAL FM (PB ON:H)
80	I.MUTE[L]	OUT	INTERLACE VIDEO SIGNAL MUTING CONTROL OUTPUT
81	MESECAN_DET	OUT	MESECAM:H
82	Vcc	-	SYSTEM POWER
83	A.MUTE[L]	OUT	AUDIO MUTE CONTROL (MUTE:L)
84	Vss	-	GND
85	SP_SHORT[H]	OUT	MODE SELECT
86	LP_SHORT[H]	OUT	MODE SELECT
87	DEC[L]	OUT	DECODER SELECT
88	H.REC_ST[H]	OUT	HIFI AUDIO SOUND RECORDING START
89	EXP_CLK	OUT	SERIAL DATA TRANSFER CLOCK FOR EXPANDER IC(IC3601)
90	EXP_DATA	IN/OUT	SERIAL DATA TRANSFER OUTPUT FOR EXPANDER IC(IC3601)
91	OSD_CS	OUT	ONSCREEN IC CHIP SELECT
92	E5_RESET	OUT	RESET OUTPUT TO IC1401
93	ADC_RST[L]	OUT	STEREO A/D CONVERTER RESET PULSE
94	SW1	OUT	TV RF SYSTEM SELECT-1
95	SW2	OUT	TV RF SYSTEM SELECT-2
96	P.SAVE[L]	OUT	POWER SAVE MODE : L
97	P_CTL[H]	OUT	POWER ON/OFF CONTRPL (POWER ON:H)
98	C_SYNC	IN	COMPOSITE SYNC INPUT
99	A_FF	OUT	AUDIO FF OUTPUT
100	V_FF	OUT	ROTATION DETECTION SIGNAL FOR DRUM MOTOR/TIMING CONTROL SIGNAL FOR REC
101	CAPPWM	OUT	CAPSTAN MOTOR CONTROL
102	DRUMPWM	OUT	DRUM MOTOR CONTROL
103	RAPID_IN	IN	RAPID CONTROL
104	RGB_IN[H]	OUT	RGB SIGNAL INPUT MODE : H
105	P.MUTE_VHS[L]	OUT	PICTURE MUTE CONTROL FOR VHS (MUTE ON:L)
106	SEPA_IN[L]	OUT	Y/C SEPARATE INPUT MODE
107	EE[L]	OUT	EE MODE:L
108	DFG	IN	DRUM FG PULSE INPUT
109	Vcc	-	SYSTEM POWER
110	V.PULSE	OUT	V.PULSE ADDITION TIMING CONTROL
111	Vss	-	GND
112	CTLREF	-	CTL REFERENCE VOLTAGE

## WAVEFORMS

### VIDEO BLOCK DIAGRAM(1)

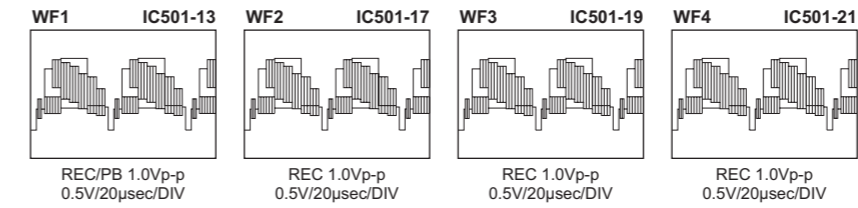

### VIDEO BLOCK DIAGRAM(2)

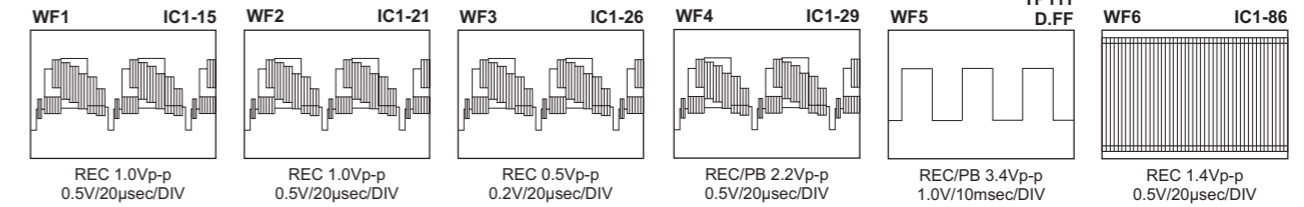

### AUDIO BLOCK DIAGRAM

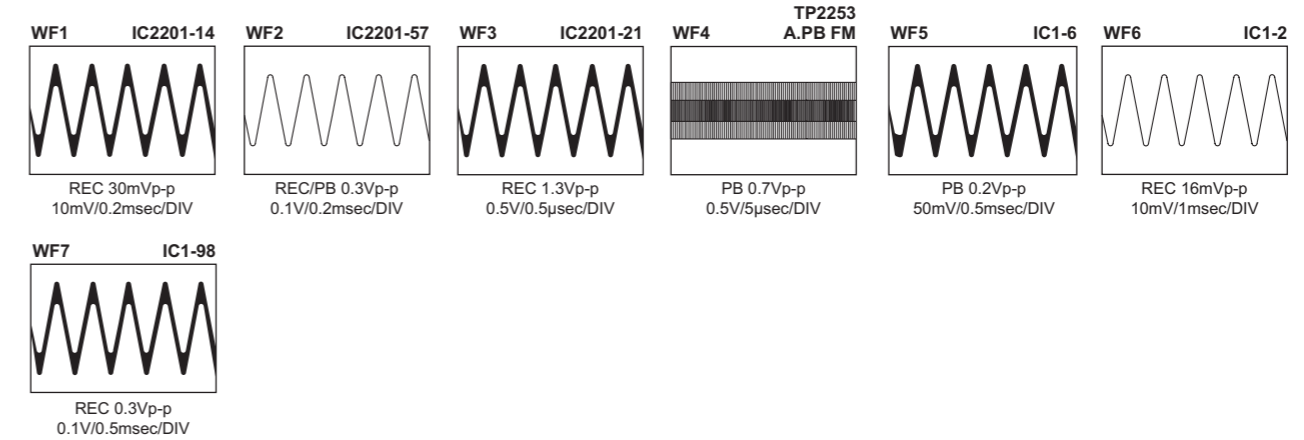

### SYSTEM CONTROL BLOCK DIAGRAM

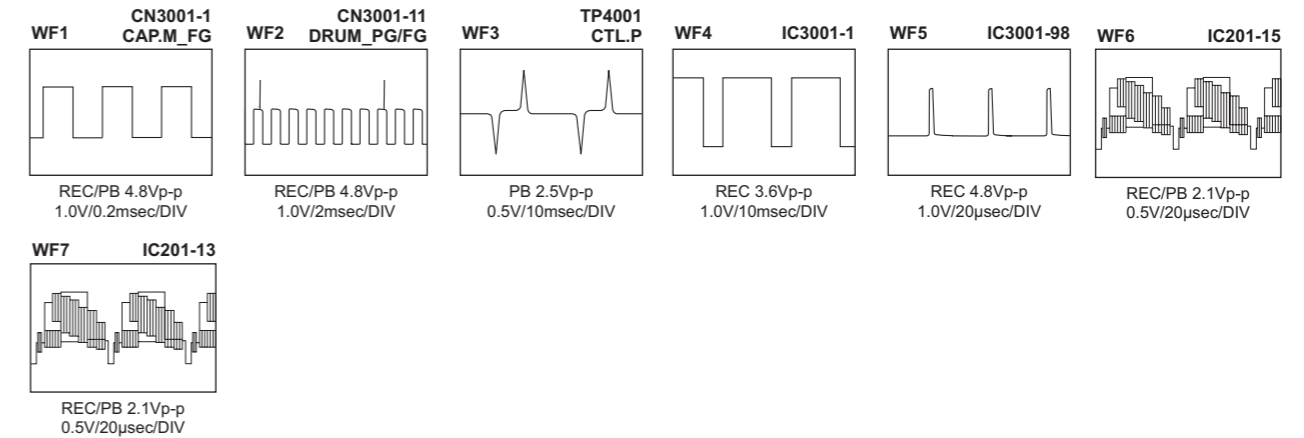



# VOLTAGE CHARTS

<SWITCHING REGULATOR>		
MODE PIN NO.	REC	PLAY
IC5101		
1	305.6	305.5
2	0	0
3	0	0
4	17.8	17.8
5	2.6	2.6
IC5301		
1	4.6	4.6
2	0	0
3	2.5	2.5
IC5302		
1	5.4	5.0
2	0	0
3	0	0
4	3.4	3.4
5	4.4	4.4
6	0	0
7	0	0
8	5.8	5.7
Q5303		
E	51.2	51.3
C	51.2	51.3
B	0	0
Q5304		
E	0	0
C	0	0
B	4.1	4.1
Q5305		
E	11.2	12
C	12.0	12
B	11.8	11.9
Q5306		
E	5.0	5.1
C	5.7	5.7
B	5.8	5.8
Q5307		
E	7.0	7.0
C	7.0	7.0
B	6.3	6.3
Q5308		
E	0	0
C	0	0
B	2.5	2.5
Q5313		
E	12	12
C	12	12
B	11.3	11.3
Q5315		
E	0	0
C	0	0
B	4.5	4.5
CN5001		
1	226	226
2	226	226
CN5301		
1	5.0	5.0
2	11.2	12.0
3	32.3	5.0
4	51.3	11.1
5	2.5	2.5
6	4.1	4.1
7	0	0
8	0	0
9	4.8	4.8
10	5.7	5.7
11	-7.1	-7.1
12	12.0	12.0
13	0	0
14	12.1	12.0
15	0	0
CN5302		
1	0	0
2	7.0	7.0
CN5303		
1	12.0	12.0
2	0	0
3	0	0
4	5.0	4.9
CN5304		
1	11.2	11.1
2	12.0	11.9
3	-7.2	-7.2
4	12.0	11.9
5	4.1	4.1
6	4.8	4.8
7	4.5	4.4
8	0	0
9	0	0
10	5.7	5.6
11	0	0
12	0	0
13	0	0
14	0	0
15	-15.9	-15.9
16	5.7	5.7
17	-19.4	-19.4
18	5.7	5.7

MODE PIN NO.	REC	PLAY
19	-30.8	-30.8

<MAIN>		
MODE PIN NO.	REC	PLAY
IC1		
1	0	0
2	0	0
3	0	0
4	5.0	5.0
5	2.1	2.1
6	2.6	2.6
7	2.8	2.9
8	0	1.4
9	1.9	1.3
10	2.3	2.0
11	2.6	3.0
12	1.5	0.6
13	0	0
14	2.8	2.3
15	2.8	2.8
16	0	3.3
17	2.8	2.8
18	2.0	1.8
19	2.8	2.8
20	0.1	0
21	2.8	2.8
22	5.0	5.0
23	2.3	2.3
24	0.1	0
25	0	0
26	3.0	2.8
27	0.1	0
28	0	0
29	2.4	2.4
30	2.9	2.9
31	0.4	0.4
32	2.3	2.3
33	2.1	0
34	1.8	1.8
35	3.0	3.0
36	2.3	2.3
37	3.0	3.0
38	2.2	2.2
39	1.5	1.5
40	2.1	2.1
41	2.6	2.6
42	2.0	2.0
43	2.1	2.1
44	0	0
45	3.0	3.0
46	3.1	3.1
47	5.0	5.0
48	0.1	0.1
49	3.3	3.3
50	5.0	5.0
51	2.0	2.0
52	5.0	5.0
53	2.7	2.7
54	0	0
55	1.9	1.4
56	0	0.1
57	2.2	2.2
58	2.3	2.3
59	5.0	5.0
60	4.9	5.0
61	0	0
62	2.3	2.2
63	2.2	2.2
64	2.5	2.7
65	2.3	2.3
66	2.7	2.6
67	0.1	0.1
68	1.3	1.2
69	2.0	2.0
70	2.8	1.8
71	2.2	2.2
72	0.1	0.1
73	4.7	4.7
74	4.7	4.7
75	2.8	2.9
76	2.3	2.2
77	2.9	2.9
78	0	0
79	0.6	2.5
80	2.6	2.4
81	4.9	4.8
82	0	0
83	0.1	0.9
84	4.9	4.9
85	2.4	2.3
86	2.4	2.3
87	2.4	2.3
88	0	0
89	0	0
90	0	0
91	0	0
92	5.0	5.0
93	0.2	0.2
94	2.6	2.5
95	2.6	2.5
96	2.5	2.5

MODE PIN NO.	REC	PLAY
97	0	0
98	2.4	2.6
99	0	0
100	2.6	2.6
IC201		
1	0	0
2	2.6	2.6
3	4.9	4.9
4	0	0
5	0	0
6	2.5	2.5
7	2.6	2.5
8	5.0	5.0
9	3.2	3.1
10	4.2	4.2
11	2.0	1.9
12	5.0	5.0
13	2.4	2.3
14	0	0
15	2.4	2.4
16	2.4	0.2
17	5.0	5.0
18	2.9	2.6
19	0	0
20	5.0	5.0
21	5.0	5.0
22	3.6	3.6
23	5.0	5.0
24	5.0	5.0
IC501		
1	0	0
2	2.9	2.9
3	5.0	4.9
4	2.9	2.9
5	0	0
6	0	0
7	2.9	2.8
8	2.9	2.9
9	2.9	2.9
10	0	0
11	1.3	1.3
12	5.0	4.9
13	1.8	1.8
14	0	0
15	1.3	1.3
16	0	0
17	1.8	1.8
18	0	0
19	2.8	2.8
20	4.9	4.9
21	0	1.2
22	0	2.2
23	2.2	2.2
24	0	5.0
25	1.2	1.2
26	0.8	0.7
27	1.7	1.7
28	2.3	2.3
29	0	4.6
30	0	4.9
31	0	0
32	0	0
33	0	1.2
34	0	0
35	4.7	4.7
36	4.7	4.7
37	0	5.0
38	2.9	2.9
39	0	0
40	1.3	1.3
41	5.0	5.0
42	1.6	1.6
43	5.0	5.0
44	1.3	1.3
45	0	0
46	1.8	1.8
47	4.9	5.0
48	1.4	1.4
49	0	0
50	0	2.9
51	0	0
52	0	0
53	0	0
54	0	0
55	0	0
56	0	0
57	0	0
58	0	1.9
59	4.9	4.9
60	2.4	2.3
61	2.4	2.3
62	2.4	2.3
63	0	0
64	0	0
65	0	0
66	0	0
67	0	0
68	0	0
69	0	0
70	0	0
71	0	0
72	0	0
73	0	0
74	0	0
75	0	0
76	0	0
77	0	0
78	0	0
79	0	0
80	0	0
81	0	0
82	0	0
83	0	0
84	0	0
85	0	0
86	0	0
87	0	0
88	0	0
89	0	0
90	0	0
91	0	0
92	0	0
93	0	0
94	0	0
95	0	0
96	0	0

MODE PIN NO.	REC	PLAY
15	0	0
16	2.5	2.5
17	9.7	0.7
18	2.5	2.5
19	2.5	2.5
20	2.5	0.5
21	2.5	0
22	2.5	0.7
23	0	0
24	2.5	0.7
25	4.9	5.0
26	2.6	0
27	0	2.7
28	4.2	2.6
29	4.1	1.8
30	3.9	1.7
31	1.0	2.0
32	2.5	2.5
33	2.5	2.5
34	0.5	0.6
35	2.5	2.5
36	0	0
37	1.7	1.7
38	0	0
39	0	0
40	5.0	5.0
41	0	0
42	4.7	4.7
43	4.7	4.7
44	3.3	3.3
45	0	0
46	4.8	4.8
47	2.5	2.5
48	2.5	2.5
49	0.1	0.2
50	0.3	0.2
51	0	0
52	0	0
53	4.4	4.4
54	0	0
55	0	0
56	0	0
57	4.5	4.4
58	11.1	11.1
59	4.5	4.5
60	0.1	0.1
61	2.5	2.5
62	2.4	2.4
63	4.4	4.4
64	4.5	4.5
IC2601		
1	0	0
2	0	0
3	0	0
4	-7.2	-7.2
5	0	0
6	0	0
7	0	0
8	0	0
9	0	0
10	5.0	5.0
11	0	0
12	0	0
13	0	0
14	4.8	4.6
15	4.8	4.8
16	0	4.9
17	0	0
18	3.9	3.9
19	0	0
20	4.4	4.5
21	0	1.8
22	0	2.5
23	0	0
24	4.8	4.9
25	0	0
26	0	0
27	0	0
28	0	0
29	0	0
30	4.5	4.6
31	4.9	4.9
32	0.1	0
33	4.9	4.9
34	6.7	0
35	2.5	2.4
36	5.0	5.0
37	0	0
38	0	0
39	0	0
40	0	0
41	4.9	4.9
42	4.8	4.9
43	0	0
44	4.8	4.9
45	0	0
46	0	0
47	0	0
48	0	0
49	0	0
50	0	0
51	0	0
52	0	0
53	0	0
54	0	0
55	0	0
56	0	0
57	0	0
58	0	0
59	0	0
60	0	0
61	0	0
62	0	0
63	0	0
64	0	0
65	0	0
66	0	0
67	0	0
68	0	0
69	0	0
70	0	0
71	0	0
72	0	0
73	0	0
74	0	0
75	0	0
76	0	0
77	0	0
78	0	0
79	0	0
80	0	0
81	0	0
82	0	0
83	0	0
84	0	0
85	0	0
86	0	0
87	0	0
8		

## ■ VOLTAGE CHARTS

<DEMOD>			<RGB YC>			<TERMINAL>			<SECAM>		
MODE PIN NO.	REC	PLAY	MODE PIN NO.	REC	PLAY	MODE PIN NO.	REC	PLAY	MODE PIN NO.	REC	PLAY
IC6701			IC4401			IC901			IC301		
1	4.2	4.2	1	0	0	1	2.4	2.5	1	0	0
2	0	1.5	2	2.2	2.3	2	0	0	2	2.0	2.0
3	1.5	1.4	3	0	2.2	3	2.3	2.3	3	4.0	4.0
4	0	0	4	2.2	2.2	4	0	0	4	0.5	0.4
5	2.0	1.9	5	0	0	5	2.4	2.4	5	0	0
6	0	0	6	2.0	2.0	6	1.0	0.8	6	3.0	3.0
7	0	0	7	0	0	7	2.3	2.4	7	0	0
8	0	0	8	4.3	4.3	8	0	0	8	2.5	2.5
9	0	0	9	0	0	9	2.4	2.1	9	2.5	2.5
10	3.6	3.6	10	4.6	4.6	10	4.0	0	10	2.3	2.3
11	0	0	11	4.0	4.1	11	0	0	11	2.6	0.1
12	4.1	3.6	12	5.0	5.0	12	1.8	1.8	12	4.4	4.4
13	3.9	3.9	13	0	0	13	3.8	4.1	13	2.5	2.6
14	0	0	14	0	0	14	4.1	3.8	14	3.1	2.0
15	0	0	15	2.4	2.3	15	2.3	2.3	15	2.7	2.7
16	0	0	16	1.6	1.6	16	0	5.0	16	0	5.0
17	0	0	17	1.5	1.5	17	2.3	2.2	17	0.8	2.6
18	0	0.2	18	0	0	18	0	2.2	18	2.2	2.2
19	5.0	5.0	19	5.0	5.0	19	2.4	2.4	19	2.4	2.4
20	0	0	20	1.5	1.5	20	0	0	20	2.5	2.5
21	0	0	21	1.8	1.8	21	2.3	2.3	21	2.5	2.5
22	4.3	4.3	22	1.7	1.8	22	1.7	1.8	22	5.0	5.0
23	0	0	23	1.8	1.8	23	4.2	4.2	23	3.0	2.9
24	0	0	24	0	0	24	1.7	1.7	24	3.0	2.9
25	0	0	IC4402			25	0.7	0	25	2.7	2.7
26	0	0	1	0.5	0.5	26	2.2	2.2	26	0.2	0.2
27	0	0	2	1.3	1.4	27	0	0	27	0.4	0.3
28	0	0	3	5.0	4.9	28	1.8	1.7	28	0.3	0
29	0	0	4	1.9	2.0	29	5.0	5.0	Q301		
30	2.3	2.3	5	0	0	30	5.0	5.0	E	2.5	2.5
31	2.3	2.3	6	2.1	2.2	31	2.1	2.1	C	2.4	2.5
32	0	0	IC4403			32	0	0	B	1.9	4.9
33	4.7	4.6	1	0	0	33	2.2	2.3	Q302		
34	3.7	3.8	2	4.7	4.8	34	0	0	E	5.0	4.9
35	0	0	3	5.0	5.0	35	1.6	2.8	C	5.0	0.5
36	2.3	2.3	4	0	0	36	2.8	2.7	B	0	4.9
37	0	0	5	0	0	37	2.2	2.1	CN301		
38	0	0	6	0.2	0.2	38	8.9	8.9	1	2.2	2.2
39	0	0	7	4.7	4.7	39	2.1	2.2	2	0.8	2.6
40	0	0	8	0	0	40	4.0	2.2	3	0.1	0.1
41	0	0	9	0.6	0.6	41	4.3	4.4	4	0	0
42	2.5	2.5	10	4.4	4.4	42	4.4	4.4	5	0.4	0.3
43	2.3	2.3	11	5.0	5.0	43	4.4	4.4	6	5.0	5.0
44	0	0	12	4.6	4.6	44	0	0	7	2.8	2.7
CN6701			13	5.0	5.0	45	4.4	4.5	8	0	4.9
1	0	0	14	1.9	1.9	46	4.4	4.4	9	0	0
2	3.6	3.6	15	0	0	47	0	0	10	2.6	0
3	4.0	3.9	16	5.0	5.0	48	4.4	4.4	11	2.3	2.1
4	0	0	IC4404			49	4.4	4.4	CN913		
5	0	0	1	0	0	50	0	0	1	0	0
6	0	0	2	2.0	1.9	51	2.2	2.2	2	0	0
7	4.9	4.9	3	0	0	52	1.9	1.8	3	0	0
8	0	0	4	1.9	1.9	53	1.9	1.8	4	0	0
9	0	0	5	0	0	54	0	0	5	0	0
10	2.1	2.1	6	0	0	55	1.5	1.5	6	0	0
			7	1.9	1.9	56	1.5	1.5	7	0	0
			8	0	0	IC902			8	0	0
			9	1.0	1.0	1	0	0	9	0	0
			10	1.0	1.0	2	1.6	1.6	10	0	0
			11	0	0	3	1.5	1.5	11	0	0
			12	1.0	1.0	4	2.4	2.4	12	0	0
			13	0.9	1.0	5	5.0	4.9	13	0	0
			14	1.0	1.0	6	2.3	2.4	CN914		
			15	1.0	1.0	7	1.5	1.5	1	0	0
			16	5.0	5.0	8	1.5	1.5	2	0	0
CN4402						Q901			3	6.1	6.3
1	0	0				E	0.2	0	4	0	0
2	1.4	1.4				C	0	11.1	5	0.5	0.6
3	0	0				B	0.8	0	6	0	0
4	0	0				Q902			7	0.6	0.6
5	4.6	4.6				E	0	10.7	8	0	0
6	0	0				C	11.2	11.2	9	0.5	0.6
7	4.5	4.5				B	0	11.1	10	0	0.2
8	2.0	2.0				Q903			11	0.5	0.6
9	5.0	5.0				E	0	0	12	0	0
10	0	0				C	0.2	11.2	13	0.4	0.7
11	0	0				B	0	0	14	5.1	5.0
12	0	0				Q904			15	0	0
						E	0	0	16	0	0
						C	0	0	17	0.2	0
						B	0	0	CN915		
						Q905			1	0	0
						E	0	0	2	0	0
						C	5.0	4.9	3	0	0
						B	0	0	4	0	0
						Q907			5	0.5	0.6
						E	0	0	6	0	0
						C	0	0	7	0.6	0.6
						B	0	0	8	0	0
						Q908			9	0.5	0.6
						E	3.8	3.8	10	0	0.2
						C	0	0	11	0.5	0.6
						B	4.0	4.1	12	0	0
						Q912			13	0.4	0.7
						E	3.0	3.0	14	5.1	5.0
						C	0	0	15	0	0



**JVC**

**Victor Company of Japan, Limited**

Digital Video Storage Category 12, 3-chome, Moriya-cho, kanagawa-ku, Yokohama, kanagawa-prefecture, 221-8528, Japan

No.YD084SCH



Printed in Japan  
VPT

# JVC

## SERVICE MANUAL

VHS & HDD & DVD VIDEO RECORDER

### DR-MX10SE, DR-MX10SEF, DR-MX10SEK



DR-MX10SE, DR-MX10SEF, DR-MX10SEK [D5VC21]

\*Since the whole mechanism assembly unit is replaced, the DVD recorder mechanism of this unit need not be adjusted.

\*For disassembling and assembling of VHS MECHANISM ASSEMBLY, refer to the SERVICE MANUAL No.86700 (MECHANISM ASSEMBLY).

#### TABLE OF CONTENTS

1	PRECAUTION	1-3
2	SPECIFIC SERVICE INSTRUCTIONS	1-8
3	DISASSEMBLY	1-11
4	ADJUSTMENT	1-14
5	TROUBLESHOOTING	1-18

# SPECIFICATION

	DR-MX10SEK	DR-MX10SE	DR-MX10SEF
<b>GENERAL</b>			
Power requirement	AC 220 V - 240 V, 50 Hz / 60 Hz		
Power consumption			
Power on	45 W		
Power off	6.7 W		
Temperature			
Operating	5°C to 35°C		
Storage	-20°C to 60°C		
Operating position	Horizontal only		
Dimensions (W × H × D)	435 mm × 96 mm × 384 mm		
Weight	6.9 kg		
<b>VIDEO/AUDIO (DVD Deck)</b>			
Recordable disc	DVD-RAM 12 cm (4.7 GB/9.4 GB*1), DVD-RAM 8 cm (1.4 GB/2.8 GB*2), DVD-R 12 cm (4.7 GB) DVD-R 8 cm (1.4 GB), DVD-RW 12 cm (4.7 GB), DVD-RW 8 cm (1.4 GB) *1 9.4 GB double-sided discs *2 2.8 GB double-sided discs		
Recording format	DVD-RAM : DVD Video Recording format DVD-R : DVD Video format, DVD Video Recording format DVD-RW : DVD Video format, DVD Video Recording format		
Recording time	Maximum 8 hours (with 4.7 GB disc) (XP): Approx. 1 hour, (SP): Approx. 2 hours, (LP): Approx. 4 hours (EP): Approx. 6 hours, (FR): Approx. 1 hour - 8 hours		
Audio recording system	Dolby Digital (2 ch), Linear PCM (XP mode only)		
Video recording compression system	MPEG2 (CBR/VBR)		
<b>VIDEO/AUDIO (HDD Deck)</b>			
Capacity	160 GB		
Recording time	(DV) : Approx. 11 hours, (XP) : Approx. 34 hours, (SP) : Approx. 69 hours (LP) : Approx. 138 hours, (EP) : Approx. 209 hours, (FR480) : Approx. 300 hours		
Audio recording system	Dolby Digital (2 ch), Linear PCM (XP mode only)		
Video recording compression system	MPEG2 (VBR)		
<b>VIDEO/AUDIO (VHS Deck)</b>			
Signal system	PAL colour signal and CCIR monochrome signal, 625 lines / 50 fields		
Recording system	DA4 (Double Azimuth) head helical scan system		
Format	VHS PAL standard		
Maximum recording time			
(SP)	240 min. with E-240 video cassette		
(LP)	480 min. with E-240 video cassette		
Signal-to-noise ratio	45 dB		
Horizontal resolution	230 lines		
Frequency range	70 Hz to 10,000 Hz (Normal audio) 20 Hz to 20,000 Hz (Hi-Fi audio)		
<b>INPUT/OUTPUT</b>			
21-pin SCART connectors	IN / OUT × 1, IN / DECODER × 1		
S-video input	Y: 1.0 Vp-p, 75 Ω, C: 0.3 Vp-p, 75 Ω		
Video input	1.0 Vp-p, 75 Ω (pin jack)		
Audio input	2 Vrms (pin jack)		
i.Link	4-pin for DV Input/Output		
Component video output	Y: 1.0 Vp-p, 75 Ω, Pb/Pr: 0.7 Vp-p, 75 Ω Corresponding to copy protection		
Digital audio output	Coaxial Corresponding to Dolby Digital and DTS Digital Surround, Bit stream Selectable in digital audio output setting menu		
G-LINK	Ø3.5 mm jack		
<b>TUNER/TIMER</b>			
Tuning system	Frequency synthesized tuner		
Signal system	PAL colour signal, 625 lines/50 fields	PAL/SECAM colour signal, 625 lines/50 field	
TV channel storage capacity	99 positions (+AUX position)		
Channel coverage (PAL B/G)	VHF : 44.5 MHz - 143 MHz/143 MHz - 470 MHz UHF : 470 MHz - 862 MHz	VHF : 47 MHz - 89 MHz/104 MHz - 300 MHz/302 MHz - 470 MHz UHF : 470 MHz - 862 MHz	VHF (LOW) : 47MHz-89MHz(E2-E4,X,Y,Z) VHF (HIGH) : 104MHz-300MHz(E5 - E12, S1-S20, M1 - M10, U1 - U10) Hyper: 302MHz - 470MHz (S21-S41) UHF: 470MHz - 862MHz (E21 - E69)
Channel coverage(SECAM-L)			VHF (LOW) : 49MHz - 65MHz (2-4) VHF (HIGH) : 104MHz-300 MHz(5-10,CATV) Hyper: 300MHz - 470MHz (CATV) UHF : 470MHz - 862MHz (21 - 69)
Clock reference	Quartz		
Memory backup time	Approx. 10 minutes		



- Specifications shown are for SP mode unless otherwise specified.
- E. & O.E. Design and specifications subject to change without notice.
- Manufactured under license from Dolby Laboratories. "Dolby" and the double-D symbol are trademarks of Dolby Laboratories.
- "DTS" and "DTS DIGITAL OUT" are trademarks of Digital Theater Systems, Inc.
- This product incorporates copyright protection technology that is protected by U.S. patents and other intellectual property rights. Use of this copyright protection technology must be authorized by Macrovision. Reverse engineering or disassembly is prohibited.
- GUIDE Plus+, SHOWVIEW, VIDEO Plus+, G-LINK are (1) registered trademarks or trademarks of, (2) manufactured under license from and (3) subject of various international patents and patent applications owned by, or licensed to, Gemstar-TV Guide International, Inc. and/or its related affiliates.
- GEMSTAR-TV GUIDE INTERNATIONAL, INC. AND/OR ITS RELATED AFFILIATES ARE NOT IN ANY WAY LIABLE FOR THE ACCURACY OF THE PROGRAM SCHEDULE INFORMATION PROVIDED BY THE GUIDE PLUS+ SYSTEM. IN NO EVENT SHALL GEMSTAR-TV GUIDE INTERNATIONAL, INC. AND /OR ITS RELATED AFFILIATES BE LIABLE FOR ANY AMOUNTS REPRESENTING LOSS OF PROFITS, LOSS OF BUSINESS, OR INDIRECT, SPECIAL, OR CONSEQUENTIAL DAMAGES IN CONNECTION WITH THE PROVISION OR USE OF ANY INFORMATION, EQUIPMENT, OR SERVICES RELATING TO THE GUIDE PLUS+ SYSTEM.
- i-LINK is a trademark of Sony Corp.

# SECTION 1 PRECAUTION

## 1.1 SAFTY PRECAUTIONS

Prior to shipment from the factory, JVC products are strictly inspected to conform with the recognized product safety and electrical codes of the countries in which they are to be sold. However, in order to maintain such compliance, it is equally important to implement the following precautions when a set is being serviced.

### 1.1.1 Precautions during Servicing

- (1) Locations requiring special caution are denoted by labels and inscriptions on the cabinet, chassis and certain parts of the product. When performing service, be sure to read and comply with these and other cautionary notices appearing in the operation and service manuals.
- (2) Parts identified by the  symbol and shaded (  ) parts are critical for safety. Replace only with specified part numbers.

#### NOTE :

**Parts in this category also include those specified to comply with X-ray emission standards for products using cathode ray tubes and those specified for compliance with various regulations regarding spurious radiation emission.**

- (3) Fuse replacement caution notice.  
Caution for continued protection against fire hazard.  
Replace only with same type and rated fuse(s) as specified.
- (4) Use specified internal wiring. Note especially:
  - Wires covered with PVC tubing
  - Double insulated wires
  - High voltage leads
- (5) Use specified insulating materials for hazardous live parts. Note especially:
  - Insulation Tape
  - PVC tubing
  - Spacers
  - Insulation sheets for transistors
  - Barrier
- (6) When replacing AC primary side components (transformers, power cords, noise blocking capacitors, etc.) wrap ends of wires securely about the terminals before soldering.

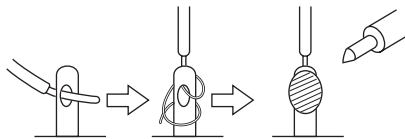

Fig. 1-1-1

- (7) Observe that wires do not contact heat producing parts (heatsinks, oxide metal film resistors, fusible resistors, etc.)
- (8) Check that replaced wires do not contact sharp edged or pointed parts.
- (9) When a power cord has been replaced, check that 10-15 kg of force in any direction will not loosen it.

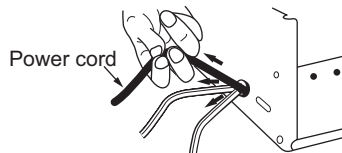

Fig. 1-1-2

- (10) Also check areas surrounding repaired locations.
- (11) Products using cathode ray tubes (CRTs) In regard to such products, the cathode ray tubes themselves, the high voltage circuits, and related circuits are specified for compliance with recognized codes pertaining to X-ray emission.

Consequently, when servicing these products, replace the cathode ray tubes and other parts with only the specified parts. Under no circumstances attempt to modify these circuits. Unauthorized modification can increase the high voltage value and cause X-ray emission from the cathode ray tube.

- (12) Crimp type wire connector In such cases as when replacing the power transformer in sets where the connections between the power cord and power transformer primary lead wires are performed using crimp type connectors, if replacing the connectors is unavoidable, in order to prevent safety hazards, perform carefully and precisely according to the following steps.

- **Connector part number** :E03830-001
- **Required tool** : Connector crimping tool of the proper type which will not damage insulated parts.
- **Replacement procedure**

- a) Remove the old connector by cutting the wires at a point close to the connector. Important : Do not reuse a connector (discard it).

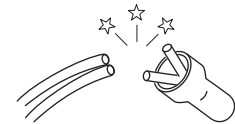

cut close to connector

Fig. 1-1-3

- b) Strip about 15 mm of the insulation from the ends of the wires. If the wires are stranded, twist the strands to avoid frayed conductors.

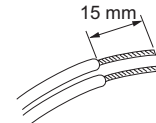

Fig. 1-1-4

- c) Align the lengths of the wires to be connected. Insert the wires fully into the connector.

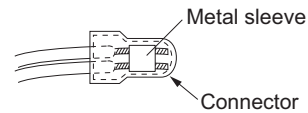

Fig. 1-1-5

- d) As shown in Fig. 1-1-6, use the crimping tool to crimp the metal sleeve at the center position. Be sure to crimp fully to the complete closure of the tool.

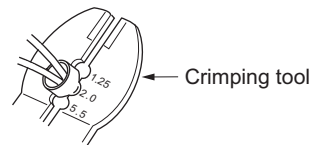

Fig. 1-1-6

- e) Check the four points noted in Fig. 1-1-7.

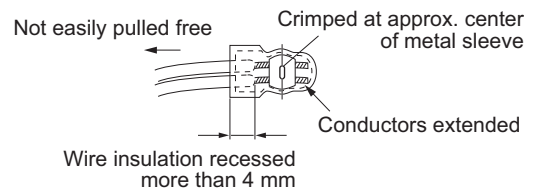

Fig. 1-1-7

### 1.1.2 Safety Check after Servicing

Examine the area surrounding the repaired location for damage or deterioration. Observe that screws, parts and wires have been returned to original positions. Afterwards, perform the following tests and confirm the specified values in order to verify compliance with safety standards.

#### (1) Insulation resistance test

Confirm the specified insulation resistance or greater between power cord plug prongs and externally exposed parts of the set (RF terminals, antenna terminals, video and audio input and output terminals, microphone jacks, earphone jacks, etc.). See table 1 below.

#### (2) Dielectric strength test

Confirm specified dielectric strength or greater between power cord plug prongs and exposed accessible parts of the set (RF terminals, antenna terminals, video and audio input and output terminals, microphone jacks, earphone jacks, etc.). See Fig.1-1-11 below.

#### (3) Clearance distance

When replacing primary circuit components, confirm specified clearance distance (d), (d') between soldered terminals, and between terminals and surrounding metallic parts. See Fig.1-1-11 below.

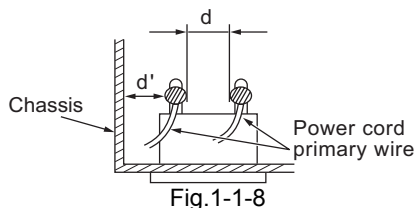

#### (4) Leakage current test

Confirm specified or lower leakage current between earth ground/power cord plug prongs and externally exposed accessible parts (RF terminals, antenna terminals, video and audio input and output terminals, microphone jacks, earphone jacks, etc.).

Measuring Method : (Power ON) Insert load Z between earth ground/power cord plug prongs and externally exposed accessible parts. Use an AC voltmeter to measure across both terminals of load Z. See Fig.1-1-9 and following Fig.1-1-12.

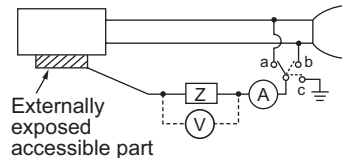

#### (5) Grounding (Class 1 model only)

Confirm specified or lower grounding impedance between earth pin in AC inlet and externally exposed accessible parts (Video in, Video out, Audio in, Audio out or Fixing screw etc.). Measuring Method:

Connect milli ohm meter between earth pin in AC inlet and exposed accessible parts. See Fig.1-1-10 and grounding specifications.

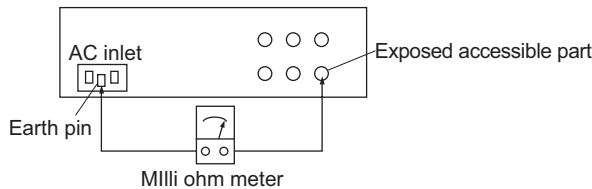

#### Grounding Specifications

Region	Grounding Impedance (Z)
USA & Canada	$Z \leq 0.1 \text{ ohm}$
Europe & Australia	$Z \leq 0.5 \text{ ohm}$

AC Line Voltage	Region	Insulation Resistance (R)	Dielectric Strength	Clearance Distance (d), (d')
100 V	Japan	$R \geq 1 \text{ M}\Omega/500 \text{ V DC}$	AC 1 kV 1 minute	$d, d' \geq 3 \text{ mm}$
100 to 240 V			AC 1.5 kV 1 minute	$d, d' \geq 4 \text{ mm}$
110 to 130 V	USA & Canada	$1 \text{ M}\Omega \leq R \leq 12 \text{ M}\Omega/500 \text{ V DC}$	AC 1 kV 1 minute	$d, d' \geq 3.2 \text{ mm}$
110 to 130 V 200 to 240 V	Europe & Australia	$R \geq 10 \text{ M}\Omega/500 \text{ V DC}$	AC 3 kV 1 minute (Class II) AC 1.5 kV 1 minute (Class I)	$d \geq 4 \text{ mm}$ $d' \geq 8 \text{ mm}$ (Power cord) $d' \geq 6 \text{ mm}$ (Primary wire)

Fig.1-1-11

AC Line Voltage	Region	Load Z	Leakage Current (i)	a, b, c
100 V	Japan		$i \leq 1 \text{ mA rms}$	Exposed accessible parts
110 to 130 V	USA & Canada		$i \leq 0.5 \text{ mA rms}$	Exposed accessible parts
110 to 130 V 220 to 240 V	Europe & Australia		$i \leq 0.7 \text{ mA peak}$ $i \leq 2 \text{ mA dc}$	Antenna earth terminals
			$i \leq 0.7 \text{ mA peak}$ $i \leq 2 \text{ mA dc}$	Other terminals

Fig.1-1-12

#### NOTE :

These tables are unofficial and for reference only. Be sure to confirm the precise values for your particular country and locality.



## 1.2 Hard Disk Drive (HDD) Handling Precautions

The HDD is a precision device for use in reading and writing a large amount of data on or from a disk rotating at a high speed. If it is not handled carefully, either abnormal operation may result or it may not be possible to read data. The HDD is sensitive to the following items and special care is required in safeguarding against them when handling an HDD. Also take care in handling a set incorporating an HDD.

- (1) Vibrations and impacts
- (2) Static electricity
- (3) Rough handling

### 1.2.1 Handling in transport, etc.

- Be sure to place the HDD in the manufacturer's specified package carton before transport.
- When receiving a package containing an HDD, check that the package carton is not damaged (such as having holes in the carton, crushed corners, etc.).
- Do not impact the packaging carton when loading or unloading it.
- It is not permitted to use the inner package carton only for transporting an HDD.
- Do not stack package cartons one upon another.

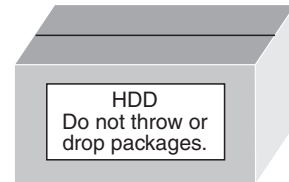

Be sure to package and transport the HDDs correctly.

### 1.2.2 Handling an HDD in the stand-alone status

- When handling an HDD on a hard workbench, place an anti-static mat (rubber sheet) or similar object on the hard surface (to prevent any impacts occurring between the HDD and bench).
- Do not stack the HDDs one upon another.
- Do not knock an HDD with a hard object (such as a screwdriver).
- Do not place an HDD on its side panel without using a support (do not place an HDD in an unstable position).



### 1.2.3 Handling the installation of an HDD

- Place antistatic mats or similar sheets on all of the surfaces on which work is conducted or when the HDD is transported.
- Do not permit the HDD to knock against the set's brackets.
- When screwing the brackets, be careful not to knock the HDD. When using a power screwdriver, use a low-shock model and arrange the tightening torque properly.
- When mounting an HDD in a main body, take care not to apply excessive force to the brackets.

### 1.3 Preventing static electricity

Electrostatic discharge (ESD), which occurs when static electricity stored in the body, fabric, etc. is discharged, can destroy the laser diode in the traverse unit (optical pickup). Take care to prevent this when performing repairs.

#### 1.3.1 Grounding to prevent damage by static electricity

Static electricity in the work area can destroy the optical pickup (laser diode) in devices such as DVD players or recorder.

Be careful to use proper grounding in the area where repairs are being performed.

(1) Ground the workbench

Ground the workbench by laying conductive material (such as a conductive sheet) or an iron plate over it before placing the traverse unit (optical pickup) on it.

(2) Ground yourself

Use an anti-static wrist strap to release any static electricity built up in your body.

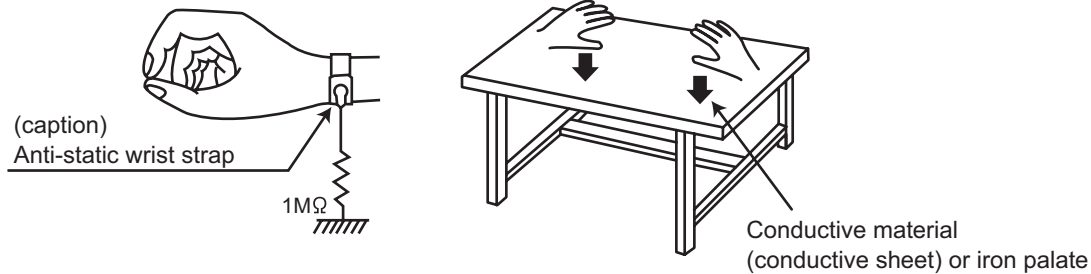

(3) Handling the optical pickup

- In order to maintain quality during transport and before installation, both sides of the laser diode on the replacement optical pickup are shorted. After replacement, return the shorted parts to their original condition. (Refer to the text.)
- Do not use a tester to check the condition of the laser diode in the optical pickup. The tester's internal power source can easily destroy the laser diode.

#### 1.4 Handling the traverse unit (optical pickup)

- (1) Do not subject the traverse unit (optical pickup) to strong shocks, as it is a sensitive, complex unit.
- (2) Cut off the shorted part of the flexible cable using nippers, etc. after replacing the optical pickup. For specific details, refer to the replacement procedure in the text. Remove the anti-static pin when replacing the traverse unit. Be careful not to take too long a time when attaching it to the connector.
- (3) Handle the flexible cable carefully as it may break when subjected to strong force.
- (4) It is not possible to adjust the semi-fixed resistor that adjusts the laser power. Do not turn it.

## 1.5 Important for laser products

### 1.CLASS 1 LASER PRODUCT

**2.DANGER** : Invisible laser radiation when open and interlock failed or defeated. Avoid direct exposure to beam.

**3.CAUTION** : There are no serviceable parts inside the Laser Unit. Do not disassemble the Laser Unit. Replace the complete Laser Unit if it malfunctions.

**4.CAUTION** : The CD,MD and DVD player uses invisible laser radiation and is equipped with safety switches which prevent emission of radiation when the drawer is open and the safety interlocks have failed or are defeated. It is dangerous to defeat the safety switches.

**5.CAUTION** : If safety switches malfunction, the laser is able to function.

**6.CAUTION** : Use of controls, adjustments or performance of procedures other than those specified here in may result in hazardous radiation exposure.

**CAUTION** Please use enough caution not to see the beam directly or touch it in case of an adjustment or operation check.

**CAUTION** : Visible and invisible laser radiation when open and interlock failed or defeated.

AVOID DIRECT EXPOSURE TO BEAM.

**ADVARSEL** : Synlig og usynlig laserstråling når maskinen er åben eller interlocken fejler. Undgå direkte eksponering til stråling.

**VARNING** : Synlig och osynlig laserstråling när den öppnas och spärren är urkopplad. Betrakta ej strålen.

**VARO** : Avattaessa ja suojalukitus ohitettuna tai viallisena olet alltiina näkyvälle ja näkymättömälle lasersäteilylle. Vältä säteen kohdistumista suoraan itseesi.

## REPRODUCTION AND POSITION OF LABEL

**CAUTION** CLASS 3B VISIBLE AND INVISIBLE LASER RADIATION WHEN OPEN. AVOID EXPOSURE TO THE BEAM.  
**ADVARSEL** KLASSE 3B SYNLIG OG USYNLIG LASERSTRÅLING VED ÅBNING. UNDGÅ UDSÆTTELSE FOR STRÅLING.  
**ADVARSEL** KLASSE 3B SYNLIG OG USYNLIG LASERSTRÅLING NÅR DEKSEL ÅPENS. UNNGÅ EKSPONERING FOR STRÅLEN.  
**VARNING** KLASSE 3B SYNLIG OCH OSYNLIG LASERSTRÅLNING NÅR DENNA DEL ÄR ÖPPNAD. STRÅLEN ÄR FARLIG.  
**VARO!** KURSSI 3B NÄKYVÄ JA NÄKYMÄTÖN AVATTAESSA OLET ALLTIINA LASERSÄTEILYLLE. ÄLÄ KATSO SÄTEESÄN.

On mechaim assembly

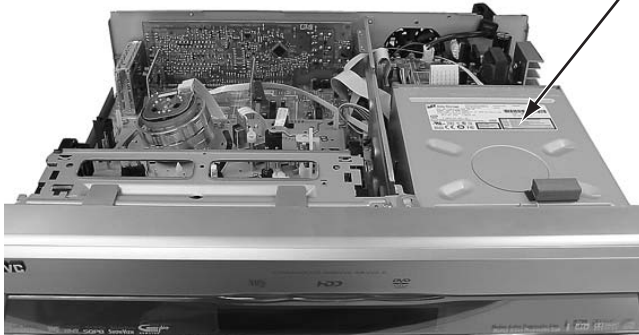

The photograph might be different from the actual thing.

## SECTION 2

### SPECIFIC SERVICE INSTRUCTIONS

#### 2.1 Different table of features

The following table indicates main different points between models DR-MX10SEK, DR-MX10SE and DR-MX10SEF.

ITEM	DR-MX10SEK	DR-MX10SE	DR-MX10SEF
POWER PLUG	3PIN	CEE	←
VHS	PAL VHS	PAL/MESECAM VHS	PAL/MESECAM/SECAM VHS
BROADCASTING STANDARD	I	B/G, D/K	L, L', B/G
STEREO DECODER	NICAM	NICAM/A2	NICAM/A2
VCR PLUS+	-	-	-
EPG	GUIDE PLUS+	←	←
VPS/PDC	X/O	O/O	X/O

#### Note:

Mark ← as same as left.

#### 2.2 Service position

This unit has been designed so that the Mechanism and Main board assemblies can be removed together from the bottom chassis. Before diagnosing or servicing the circuit boards, take out the major parts from the bottom chassis.

##### 2.2.1 How to set the "Service position"

- (1) Refer to the disassembly procedure and perform the disassembly of the major parts before removing the Mechanism assembly.
- (2) Remove the screws that fix the Mechanism, Main board assembly to the bottom chassis. If any other screws are used to fix the boards, remove them also.
- (3) Remove the combined Mechanism, HDD, DVD unit, switching regulator, digital, junction and Main board assemblies.
- (4) If any other major parts are used, remove them also.
- (5) Connect the wires and connectors of the major parts that have been removed in steps (1) to (4). (Refer to Fig. 2-2a.)
- (6) Place the combined Mechanism, Main board and other board assemblies upside down.
- (7) Insert the power cord plug into the power outlet and then proceed with the diagnostics and servicing of the board assembly.

#### Notes:

- Before inserting the power cord plug into the power outlet, make sure that none of the electrical parts are able to short-circuit between the workbench and the board assembly.
- For the disassembly procedure of the major parts and details of the precautions to be taken, see "Removing the major parts".
- If there are wire connections from the Main board and Mechanism assemblies to the other major parts, be sure to remove them (including wires connected to the major parts) first before performing step (2).
- When carrying out diagnosis and repair of the Main board assembly in the "Service position", be sure to ground both the Main board and Mechanism assemblies. If they are improperly grounded, there may be noise on the playback picture or FDP counter display may move even when the mechanism is kept in an inoperative status.

- In order to diagnose the playback or recording of the cassette tape, set the Mechanism assembly to the required mode before placing it upside down. If the mechanism mode is changed (including ejection) while it is in an upside down position the tape inside may be damaged.
- For some models, the mechanism and board assemblies are attached by connectors only. When carrying out a diagnosis or repair of the boards in the "Service position", make sure that the connectors are not disconnected.

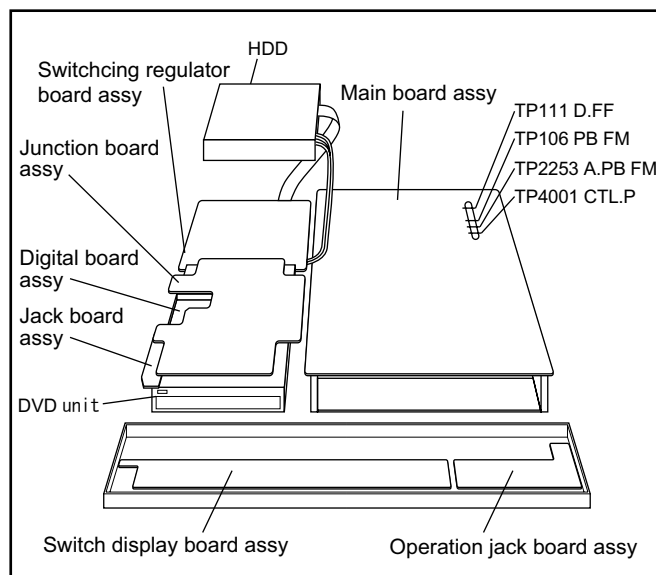

Fig.2-2a

### 2.3 Jig RCU mode

This unit uses the following two modes for receiving remote control codes.

- (1) User RCU mode: Ordinary mode for use by the user.
- (2) Jig RCU mode: Mode for use in production and servicing.

When using the Jig RCU, it is required to set the unit to the Jig RCU mode (the mode in which codes from the Jig RCU can be received). As both of the above two modes are stored in the EEPROM, it is required to set the unit back to the User RCU mode each time that an adjustment is made or to check that the necessary operations have been completed. These modes can be set by the operations described below.

#### Note:

- When the unit is set to Jig RCU mode and when the unit is under Jig RCU mode, the remote control unit attached to product operates only in "Remote Control Code 1". Since the unit is in "Remote Control Code 3" when it is shipped and just after its batteries are changed, "Remote Control Code 3" needs to be changed to "Remote Control Code 1."
- Confirm the RCU mode when exchanged parts. Since some SERVICE PARTS sets the unit to the Jig RCU mode as initial setting. Therefore please set the unit to the user RCU mode after replacing the EEPROM.

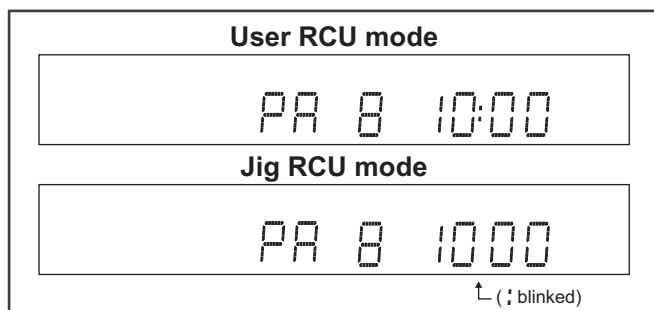

Fig.2-3a User/Jig RCU mode

#### 2.3.1 Changing Remote Control Code

- (1) Slide the TV/CABLE/SAT/DVD switch to DVD.
- (2) Press the numeric button "1" of the remote control unit while pressing the "SET UP" button of the remote control unit. Then, press the "ENTER" button, and then release the "SET UP" button.
- (3) Press the "POWER" button on the unit to turn off the unit.
- (4) Press the "PLAY" button on the unit for over 5 seconds while the unit is turned off. The code currently set appears on the front display panel.
- (5) Press the "STOP" button on the remote control to change the unit's code. When FDP indicator displays "DVD1," it means that the Remote Control Code has been changed to "1."

#### 2.3.2 Setting the Jig RCU mode

- (1) Turn on the power.
- (2) Press the "VHS/HDD/DVD SELECT" button repeatedly on the unit so that the VHS lamp lights up on the unit.
- (3) Press the following remote keys continuously within 2 seconds "SET UP" → "2" → "8" → "ENTER".  
When the unit is set to the Jig RCU mode, the symbols ( " : " ) in the time display of the FDP are blinked.  
(Refer to Fig.2-3a User/Jig RCU mode)

#### 2.3.3 Setting the User RCU mode

- (1) Turn off the power.

- (2) Press the "REC" and "PAUSE" buttons of the VCR simultaneously. Alternatively, transmit the code "43-9D" from the Jig RCU.

### 2.4 Mechanism service mode

This model has a unique function to enter the mechanism into every operation mode without loading of any cassette tape. This function is called the "Mechanism service mode".

#### 2.4.1 How to set the "Mechanism service mode"

- (1) Set the unit to the Jig RCU mode (the mode in which codes from the Jig RCU can be received)
- (2) Transmit the code "43-E5" from the Jig RCU.
- (3) Release the lug of the Cassette holder and then slide the Cassette holder toward the direction where the Cassette holder is loaded by manually.
- (4) The cassette holder lowers and, when the loading has completed, the mechanism enters the desired mode.  
When the unit is set to the Mechanism service mode, the symbols ("TIMER") in the FDP (LED) are blinked.

#### 2.4.2 How to exit from the "Mechanism service mode"

- (1) Unplug the power cord plug from the power outlet.

### 2.5 Maintenance and inspection

#### 2.5.1 Cleaning

Regular cleaning of the transport system parts is desirable but practically impossible. So make it a rule to carry out cleaning of the tape transport system whenever the machine is serviced. When the video head, tape guide and/or brush get soiled, the playback picture may appear inferior or at worst disappear, resulting in possible tape damage.

#### Note:

- Absolutely avoid sweeping the upper drum vertically as this will cause damage to the video head.
- (1) When cleaning the upper drum (especially the video head), soak a piece of closely woven cloth with alcohol and while holding the cloth onto the upper drum by the fingers, turn the upper drum counterclockwise.
  - (2) To clean the parts of the tape transport system other than the upper drum, use a piece of closely woven cloth or a cotton swab soaked with alcohol.
  - (3) After cleaning, make sure that the cleaned parts are completely dry before using the cassette tape.

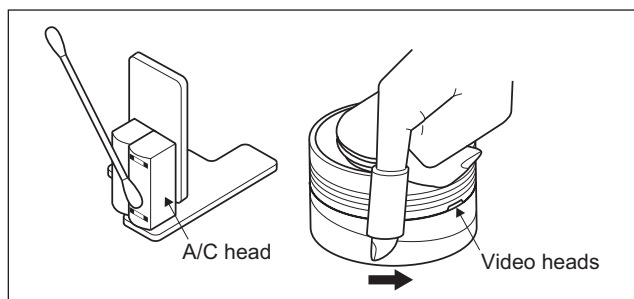

Fig.2-5a

#### 2.5.2 Lubrication

With no need for periodical lubrication, you have only to lubricate new parts after replacement. If any oil or grease on contact parts is soiled, wipe it off and newly lubricate the parts.

#### Note:

- See the "mechanism assembly" diagram of the "parts list" for the lubricating or greasing spots, and for the types of oil or grease to be used.

### 2.5.3 Suggested servicing schedule for main components

The following table indicates the suggested period for such service measures as cleaning, lubrication and replacement. In practice, the indicated periods will vary widely according to environmental and usage conditions. However, the indicated components should be inspected when a set is brought for service and the maintenance work performed if necessary. Also note that rubber parts may deform in time, even if the set is not used.

System	Parts name	Operation hours	
		1000H	2000H
Tape transport	Drum assembly	C,X	X
	A/C head	C,X	C,X
	Pinch roller arm assembly	C	C
	Full erase head	C	C
	Tension arm assembly	C	C
	Capstan motor (Shaft)	C	C
	Guide arm assembly	C	C
Drive	Capstan motor		X
	Capstan brake assembly		X
	Main brake assembly		X
	Belt (Capstan)	X	X
	Loading motor		X
	Clutch unit		X
	Worm gear		X
	Control plate		X
Other	Rotary encoder		X

C : Cleaning

X : Inspection or Replacement if necessary

# SECTION 3 DISASSEMBLY

## 3.1 Removing the major parts

### 3.1.1 Destination of connectors

Two kinds of double-arrows in connection tables respectively show kinds of connector/wires.

↔ : Flat wire   ↔ : Wire   ↔ : Board to board (B-B)

▬ : The connector of the side to remove

CONN. No.	CONNECTOR				PIN No.	
WR2a	Main	CN101	↔	Digital	CN761	40
WR2b	Main	CN103	↔	Digital	CN762	10

### Destination of connectors

CONN. No.	CONNECTOR				PIN No.	
WR2a	Main	CN7112	↔	Operation/jack	CN7201	9
WR2b	Main	CN3102	↔	Switch/display	CN7001	15
WR3a	Main	CN2001	↔	A/C head		6
WR3b	Drum assembly		↔	Main	CN1	7
WR4a	DVD unit		↔	Digital	CN2201	40
WR4b	DVD unit		↔	SW. REG.	CN5303	4
WR5a	HDD		↔	Digital	CN2101	40
CN7108 (CN1101)	Junction	CN7108	↔	Digital	CN1101	15
CN7109 (CN1102)	Junction	CN7109	↔	Digital	CN1102	15
CN4104 (CN1801)	Jack	CN4104	↔	Digital	CN1801	9
WR7a	Junction	CN7104	↔	Video switch	CN501	4
WR7b	Main	CN3103	↔	Junction	CN7102	19
WR7c	Main	CN2601	↔	Junction	CN8001	11
WR7d	Junction	CN7107	↔	Main	CN7111	13
WR7e	SW. REG.	CN5304	↔	Junction	CN5501	19
WR7f	Digital	CN1103	↔	Junction	CN7110	19
WR8a	SW. REG.	CN5301	↔	Main	CN5311	15
WR8b	SW. REG.	CN5302	↔	Fan motor		2
WR8c	Junction	CN5504	↔	HDD		4
WR8d	SW. REG.	CN5303	↔	DVD unit		4

### 3.1.2 How to read the procedure table

This table shows the steps for disassembly of the externally furnished parts and board assemblies. Reverse these steps when re-assembling them.

Step/LocNo.	Part Name	Fig. No.	Point	Note
[1]	Top cover	3-1a	4(S1a),(S1b),3(L1a), 2(SD1a),(P1a),(W1a), CN1(WR1a), 2(S1c)	<Note 1a>
	Bracket			

↑ (1)            ↑ (2)            ↑ (3)            ↑ (4)            ↑ (5)

#### (1) Order of steps in Procedure

When reassembling, perform the step(s) in the reverse order.

These numbers are also used as the identification (location) No. of parts Figures.

#### (2) Part name to be removed or installed.

#### (3) Fig. No. showing procedure or part location.

(4) Identification of part to be removed, unhooked, unlocked, released, unplugged, unclamped or unsoldered.

P= Spring, W= Washer, S= Screw, L= Locking tab, SD= Solder, CN\*\*(WR\*\*)= Remove the wire (WR\*\*) from the connector (CN\*\*).

#### Note:

- The bracketed ( ) WR of the connector symbol are assigned nos. in priority order and do not correspond to those on the spare parts list.

(5) Adjustment information for installation

### 3.1.3 Disassembly procedure

Step/LocNo.	Part Name	Fig. No.	Point	Note
[1]	Top cover	3-1e	8(S1a)	
[2]	Front panel assembly (Operation/jack board assembly) (Switch/display board assembly)	3-1a 3-1d 3-1e	3(L2a),5(L2b) CN7112(WR2a) CN3102(WR2b)	<Note2a> <Note2b>
[3]	Mechanism assembly (Drum assembly)	3-1b 3-1c 3-1d 3-1e	CN2001(WR3a) 3(S3a),(S3b) CN1(WR3b) 3(S3c),(S3d),(S3e)	<Note2a> <Note3a> <Note3b>
[4]	DVD unit (Bracket)	3-1e 3-1d	4(S4a),4(S4b) (WR4a),(WR4b)	<Note2a>
[5]	Digital board assembly and Jack board assembly	3-1d 3-1e	4(S5a),CN2101(WR5a)(S5b) CN7108(CN1101),CN7109(CN1102)	<Note2a>
[7]	Junction board assembly	3-1d 3-1e	(S7a),CN7104(WR7a), CN3103(WR7b),CN2601 (WR7c),CN7104(WR7d), CN5304(WR7e),CN5504(WR8c)	<Note2a>
[8]	Switching Regulator board assembly	3-1d 3-1e	4(S8a) CN5301(WR8a), CN5302(WR8b), CN5303(WR8c), CN5304(WR7e)	<Note2a>
[9]	Rear cover	3-1e	(S9a),7(S9b),2(S9c),3(L9a)	
[10]	HDD(Bracket, sheet)	3-1e	4(S10a),4(S10b)	
[11]	Main board assembly	3-1e	3(S11a)	

#### < Note 2a >

- Be careful not to damage the connector and wire etc. during connection and disconnection.
- When connecting the flat wire to the connector, be careful with the flat wire direction.

< Note 2b >

- When reattaching the Front panel assembly, make sure that the door opener of the Side frame (R) is lowered in position prior to the reinstallation.
- When reattaching the Front panel assembly, pay careful attention to the switch lever of the Front panel assembly not to make it touch the switch knob of the Main board assembly from the side.
- When reattaching the Front panel assembly, lift the Cassette door slightly.

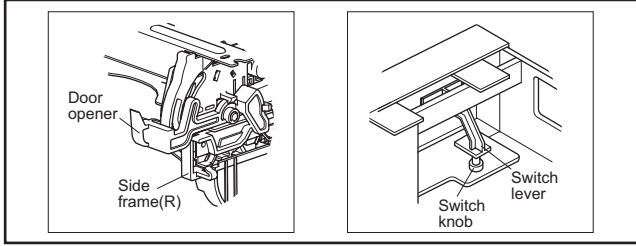

Fig.3-1a

< Note 3a >

- When reattaching the Mechanism assembly, secure the screws (S3a to S3b) in the order of 1,2,3.

< Note 3b >

- When reattaching the Mechanism assembly, be sure to align the phase of the Rotary encoder on the Main board assembly.
- When reattaching the Mechanism assembly, set the "Mechanism assembling mode". [See "MECHANISM ASSEMBLY SERVICE MANUAL (No. 86700)".]

- When reattaching the Mechanism assembly to the Main board assembly, take care not to damage the sensors and switch on the Main board assembly.

< Note 3c >

- When reattaching the Drum assembly, secure the screws (S3c to S3e) in the order of c, d, e.

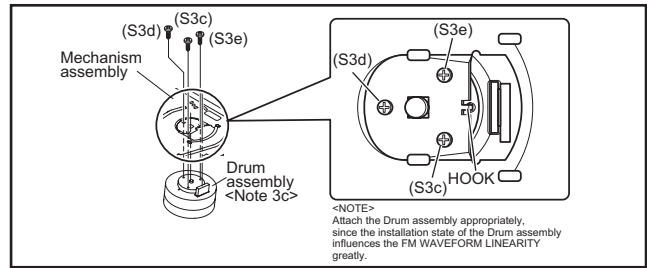

Fig.3-1b

- When handling the drum assembly alone, hold it by the motor or shaft. Be careful not to touch other parts, especially the video heads. Also take care not to damage the connectors.

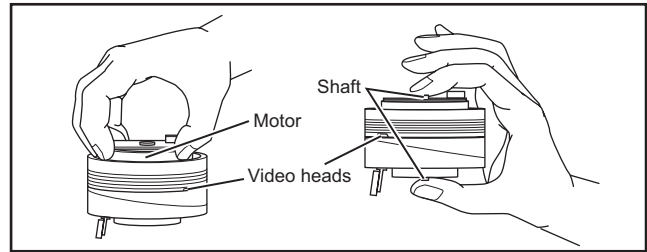

Fig.3-1c

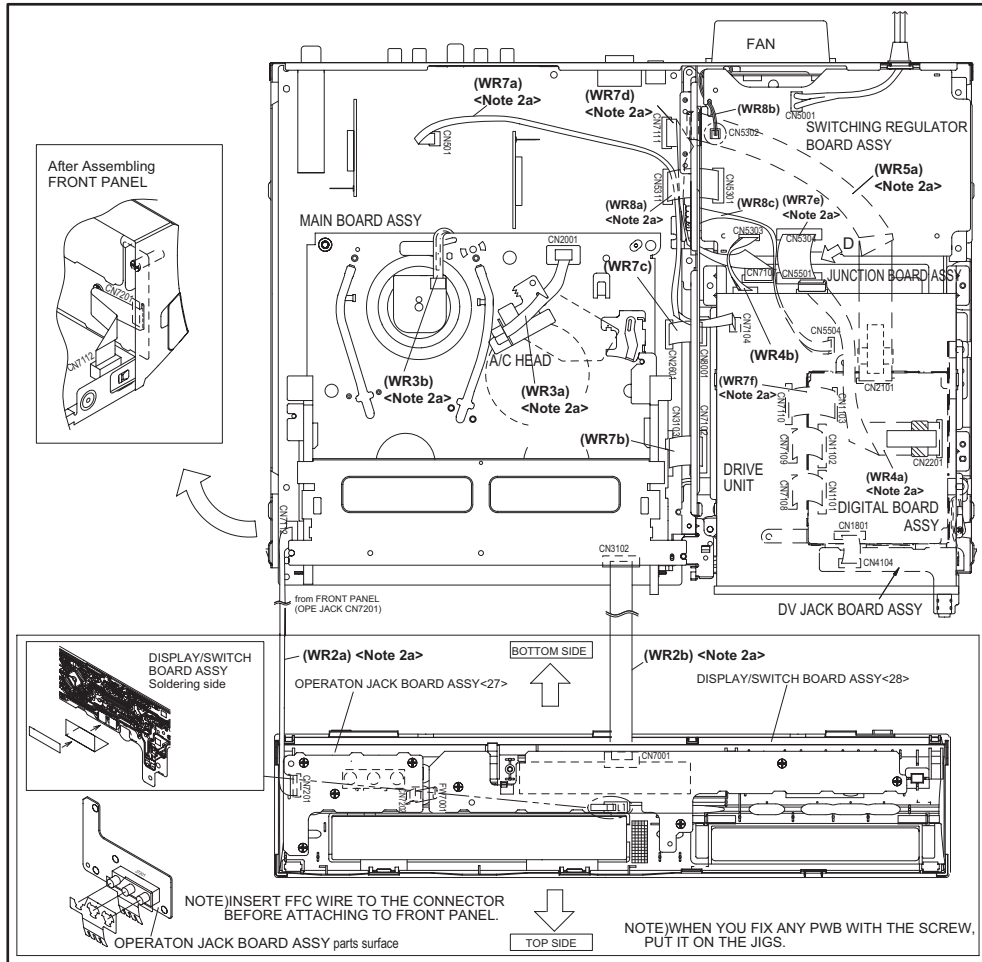

Fig.3-1d



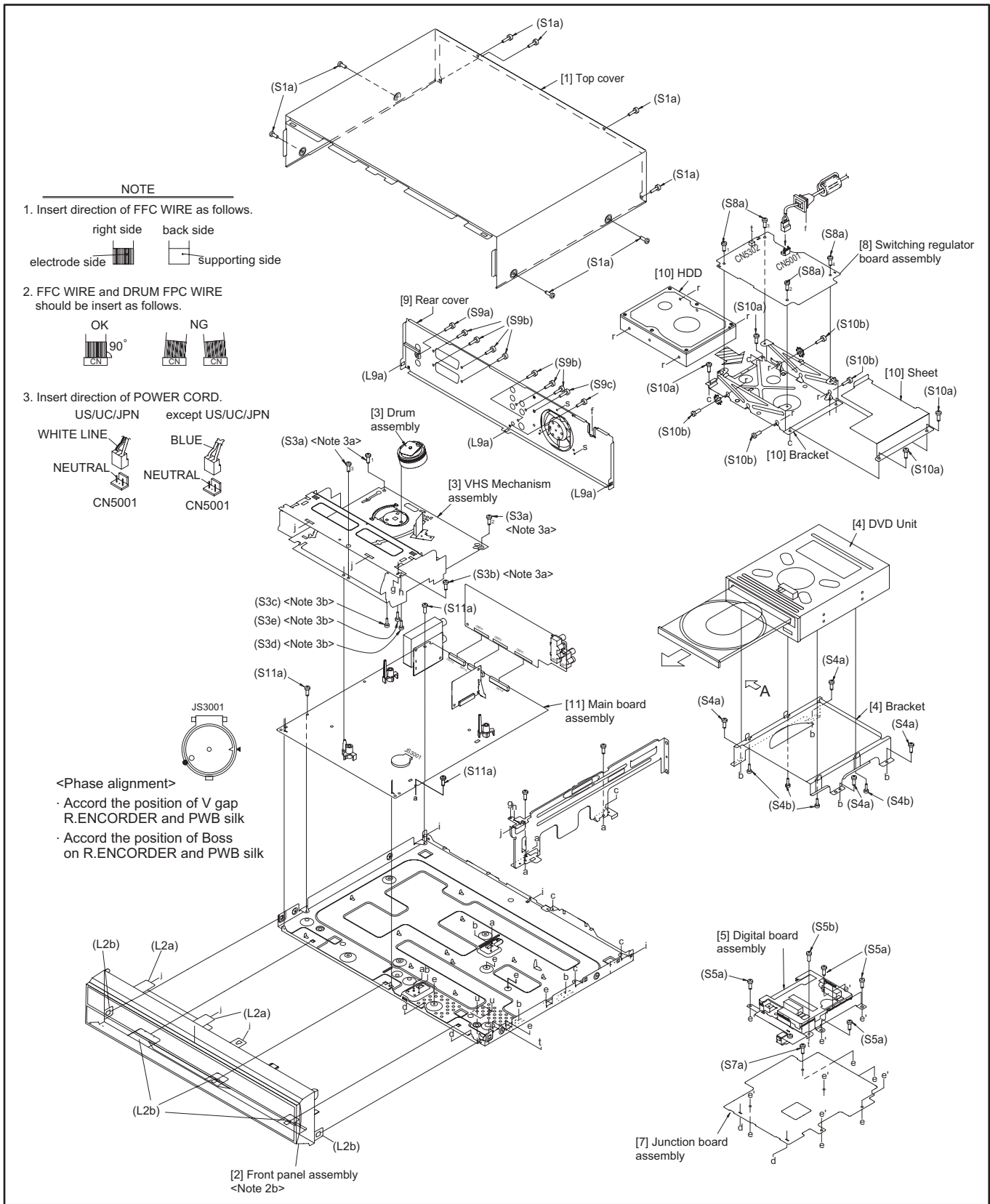

Fig.3-1e

# SECTION 4 ADJUSTMENT

## 4.1 Before adjustment

### 4.1.1 Precaution

- The adjustments of this unit include the mechanism compatibility and electrical adjustments. During the performance of this work, be sure to observe the precautions for each type of adjustment.
- If there is a reference to a signal input method in the signal column of the adjustment chart, "Ext. S-input" means the Y/C separated video signal and "Ext. input" means the composite video signal input.
- Unless otherwise specified, all measuring points and adjustment parts are located on the Main board.

### 4.1.2 Required test equipments

- Color (colour) television or monitor
- Oscilloscope: wide-band, dual-trace, triggered delayed sweep
- Signal generator: RF / IF sweep / marker
- Signal generator: stairstep, color (colour) bar [PAL]
- Recording tape
- Digit-key remote controller(provided)

### 4.1.3 Required adjustment tools

● : Used --- : Not used

	Mechanism compatibility adjustment	Electrical adjustment
Roller driver	●	---
Jig RCU	---	●
Back tension cassette gauge	●	---
Alignment tape(MHPE)	●	---
Alignment tape(MHPE-L)	●	●

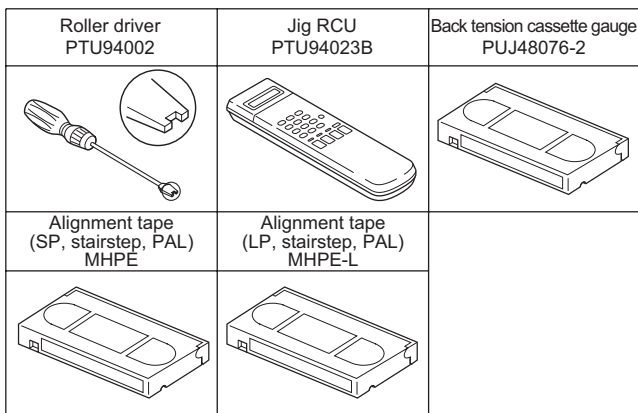

### 4.1.4 Color (colour) bar signal, Color (colour) bar pattern

#### • Colour bar signal [PAL]

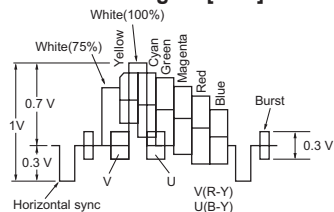

#### • Colour bar pattern [PAL]

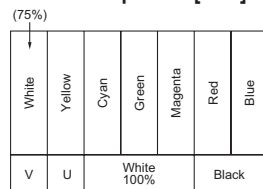

### 4.1.5 Switch settings

When adjusting this unit, set the VCR mode and switches as described below.

- When using the Jig RCU, it is required to set the unit to the Jig RCU mode (the mode in which codes from the Jig RCU can be received). (See "section 2 SPECIFIC SERVICE INSTRUCTIONS".)

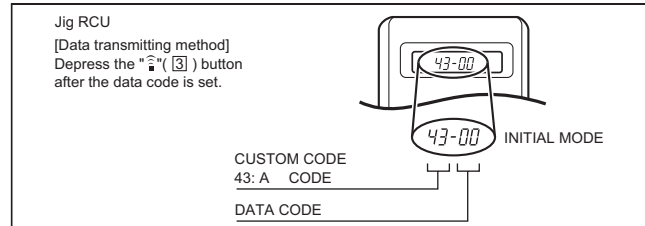

Fig.4-1a Jig RCU [PTU94023B]

- Set the switches as shown below unless otherwise specified on the relevant adjustment chart. The switches that are not listed below can be set as desired.

If the VCR is not equipped with the functions detailed below, setup is not required.

AUTO PICTURE/VIDEO CALIBRATION/ B.E.S.T./D.S.P.C.	OFF
PICTURE CONTROL/SMART PICTURE	NORMAL/NATURAL
VIDEO STABILIZER	OFF
TBC	ON
Digital 3R	ON
VIDEO NAVIGATION/TAPE MANAGER	OFF
BLUE BACK	OFF

### 4.1.6 Manual tracking mode (Auto tracking ON/OFF) setting

- (1) In order to set to the manual tracking mode during tape playback, press the "CHANNEL +/-" button on the unit simultaneously.
  - When the manual tracking mode is set, the tracking is placed at the center position.
- (2) Press "CHANNEL +/-" to adjust the tracking manually.

### 4.1.7 EVR Adjustment

Some of the electrical adjustments require the adjustment performed by the EVR system. The main unit have EEPROMs for storing the EVR adjustment data and user setups.

#### Notes:

- In the EVR adjustment mode, the value is varied with the channel buttons (+, -). The adjusted data is stored when the setting mode changes (from PB to STOP, when the tape speed is changed, etc.). Take care to identify the current mode of each adjustment item when making an adjustment.
- When changing the address setting in the EVR adjustment mode, use the Jig RCU or the remote controller having numeric keypad with which a numeric code can be directly input.  
The remote control code of the Jig RCU corresponds to each of the digit keys on the remote controller as follows.

Digit-key	0	1	2	3	4	5	6	7	8	9
Code	20	21	22	23	24	25	26	27	28	29

- As the counter indication and remaining tape indication are not displayed FDP during the EVR adjustment mode, check them on the TV monitor screen.
- When performing the EVR adjustment, confirm that the FDP indication is changed to the EVR mode.

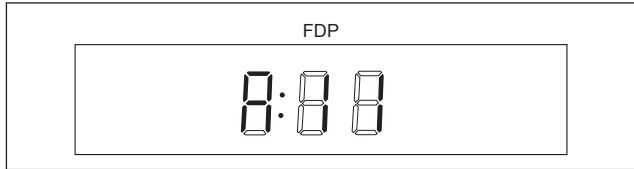

Fig.4-1b EVR mode

#### 4.2 Mechanism compatibility adjustment (VHS SECTION)

##### Notes:

- Although compatibility adjustment is very important, it is not necessary to perform this as part of the normal servicing work. It will be required when you have replaced the A/C head, drum assembly or any part of the tape transport system.
- To prevent damaging the alignment tape in the compatibility adjustment, prepare a cassette tape (for self-recording/playback), perform a test on it by transporting it and making sure that the tape is not bent by the tape transport mechanisms such as in the guide rollers. (See Fig.4-2b.)

##### 4.2.1 Tension pole position

##### Notes:

- This adjustment must be performed every time the tension band is replaced.

Signal	(A)	• Back tension cassette gauge [PUJ48076-2]
Mode	(B1) (B2)	• PB • Eject end
Adjustment part	(F)	• Adjust pin [Mechansim assembly]
Specified value	(G)	• 25 - 51 gf·cm (2.45 - 5 x 10 <sup>-3</sup> Nm)

- (1) Play back the back tension cassette gauge (A).
- (2) Check that the indicated value on the left side gauge is within the specified value (G).
- (3) If the indicated value is not within the specified value (G), perform the adjustment in a following procedure. (See Fig.4-2a.)
  - a) Remove the top frame, cassette holder and side frames (L/R) all together. (Refer to the SERVICE MANUAL No.86700 [MECHANISM ASSEMBLY].)
  - b) Rotate the loading motor gear to move the control plate so that the triangular stamping to the left of the "P" stamping is aligned with the stamping (a) on the main deck. This positioning is mode (B1).
  - c) Adjust by turning the adjustment pin so that the tip of the tension arm is aligned with the stamping (b) on the main deck.
  - d) Rotate the reel disk (S) by about one turn clockwise and make sure that the round hole of the adjustment pin is located in the "OK" range. If it is outside this range, restart the adjustment from the beginning.

After completion of the adjustment, rotate the loading gear motor to return it to the mode (B2) position.

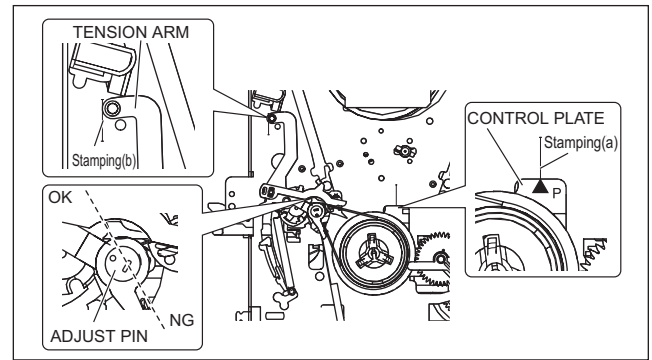

Fig.4-2a

##### 4.2.2 FM waveform linearity

Signal	(A1) (A2)	• Alignment tape(SP, stairstep, PAL) [MHPE] • Alignment tape(LP, stairstep, PAL) [MHPE-L]
Mode	(B)	• PB
Equipment	(C)	• Oscilloscope
Measuring point	(D)	• TP106 (PB, FM)
External trigger	(E)	• TP111 (D,FF)
Adjustment part	(F)	• Guide roller [Mechanism assembly]
Specified value	(G)	• Flat V.PB FM waveform
Adjustment tool	(H)	• Roller driver [PTU94002]

- (1) Play back the alignment tape (A1).
- (2) Apply the external trigger signal to D.FF (E), to observe the V.PB FM waveform at the measuring point (D).
- (3) Set the VCR to the manual tracking mode.
- (4) Make sure that there is no significant level drop of the V.PB FM waveform caused by the tracking operation, with its generally parallel and linear variation ensured. Perform the following adjustments when required. (See Fig. 4-2c.)
- (5) Reduce the V.PB FM waveform by the tracking operation. If a drop in level is found on the left side, turn the guide roller of the pole base assembly (supply side) with the roller driver to make the V.PB FM waveform linear. If a drop in level is on the right side, likewise turn the guide roller of the pole base assembly (take-up side) with the roller driver to make it linear. (See Fig. 4-2c.)
- (6) Make sure that the V.PB FM waveform varies in parallel and linearly with the tracking operation again. When required, perform fine-adjustment of the guide roller of the pole base assembly (supply or take-up side).
- (7) Unload the cassette tape once, play back the alignment tape (A1) again and confirm the V.PB FM waveform.
- (8) After adjustment, confirm that the tape wrinkling does not occur at the roller upper or lower limits. (See Fig. 4-2b.) [Perform adjustment step (9) only for the models equipped with SP mode and EP (or LP) mode.]

**[Perform adjustment step (9) only for the models equipped with SP mode and EP (or LP) mode.]**

- (9) Repeat steps (1) to (8) by using the alignment tape (A2).

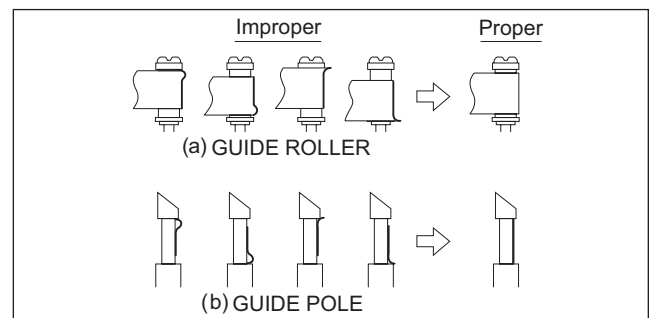

Fig.4-2b

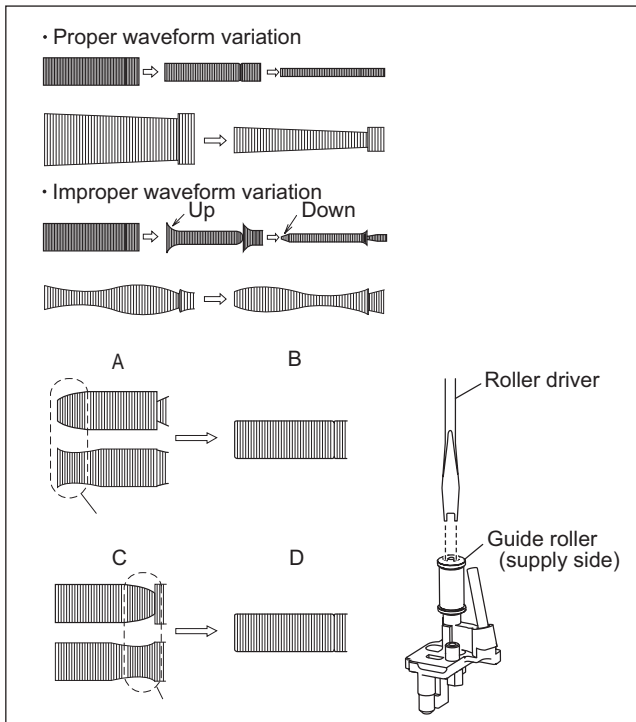

Fig.4-2c

#### 4.2.3 Height and tilt of the A/C head

**Note:**

- Set a temporary level of the height of the A/C head in advance to make the adjustment easier after the A/C head has been replaced. (Refer to the SERVICE MANUAL No.86700 [MECHANISM ASSEMBLY].)

Signal	(A)	• Alignment tape(SP, stairstep, PAL) [MHPE]
Mode	(B)	• PB
Equipment	(C)	• Oscilloscope
Measuring point	(D1)	• TP106 (PB, FM)
	(D2)	• TP4001 (CTL, P)
External trigger	(E)	• TP111 (D,FF)
Adjustment part	(F)	• A/C head [Mechanism assembly]
Specified value	(G)	• Maximum waveform

- (1) Play back the alignment tape (A).
- (2) Apply the external trigger signal to D.FF (E), to observe the AUDIO OUT waveform and Control pulse waveform at the measuring points (D1) and (D2) in the ALT mode.
- (3) Set the unit to the manual tracking mode.
- (4) Adjust the AUDIO OUT waveform and Control pulse waveform by turning the screws (1), (2) and (3) little by little until both waveforms reach maximum. The screw (1) and (3) are for adjustment of tilt and the screw (2) for azimuth.

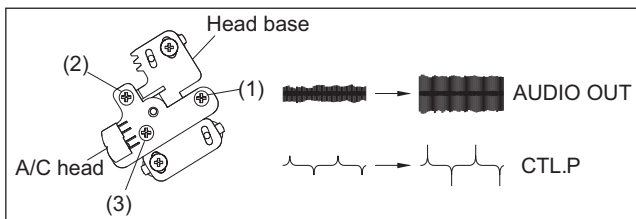

Fig.4-2d

#### 4.2.4 A/C head phase (X-value)

Signal	(A1)	• Alignment tape(SP, stairstep, PAL) [MHPE]
	(A2)	• Alignment tape(LP, stairstep, PAL) [MHPE-L]
Mode	(B)	• PB
Equipment	(C)	• Oscilloscope
Measuring point	(D)	• TP106 (PB, FM)
External trigger	(E)	• TP111 (D,FF)
Adjustment part	(F)	• A/C head base [Mechanism assembly]
Specified value	(G)	• Flat V.PB FM waveform
Adjustment tool	(H)	• Roller driver [PTU94002]

- (1) Play back the alignment tape (A1).
- (2) Apply the external trigger signal to D.FF (E), to observe the V.PB FM waveform at the measuring point (D).
- (3) Set the VCR to the manual tracking mode.
- (4) Loosen the screws (4) and (5), then set the Roller driver to the innermost projected part of the A/C head. (See Fig. 4-2e.)
- (5) Rotate the roller driver so that the A/C head comes closest to the capstan. From there, move the A/C head back gradually toward the drum until the point where the FM waveform is maximized for the second time, and then tighten the screws (4) and (5) temporarily.
- (6) Play an alignment tape (A2) and set to the manual-tracking mode.
- (7) Fine-adjust A/C head base position to maximize the FM waveform, and then tighten the screws (4) and (5) firmly.
- (8) Play alignment tapes (A1) and (A2) and confirm that the FM waveforms are maximized when the tracking is at the center position.

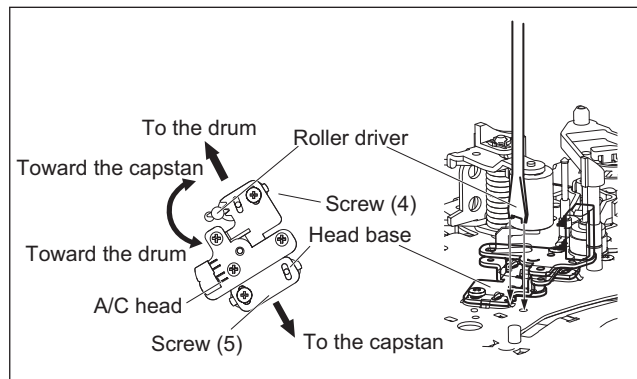

Fig.4-2e

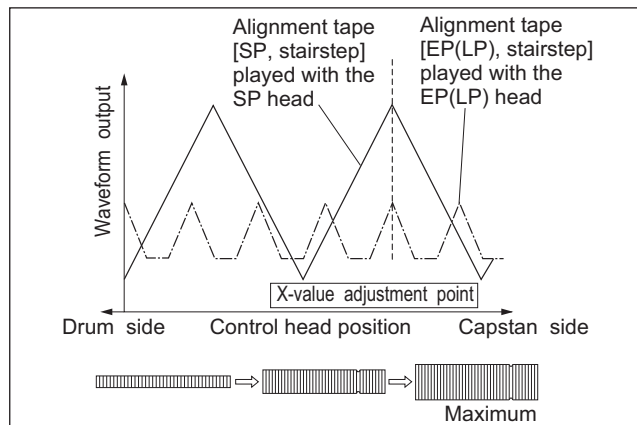

Fig.4-2f

### 4.3 Electrical adjustment

#### Note:

The following adjustment procedures are not only necessary after replacement of consumable mechanical parts or board assemblies, but are also provided as references to be referred to when servicing the electrical circuitry.

In case of trouble with the electrical circuitry, always begin a service by identifying the defective points by using the measuring instruments as described in the following electrical adjustment procedures. After this, proceed to the repair, replacement and/or adjustment. If the required measuring instruments are not available in the field, do not change the adjustment parts (variable resistor, etc.) carelessly.

#### 4.3.1 Servo circuit

##### 4.3.1.1 Switching point

Signal	(A1) (A2)	• Stairstep signal • Alignment tape(LP, stairstep, PAL) [MHPE-L]
Mode	(B)	• PB
Equipment	(C)	• Oscilloscope
Measuring point	(D)	• VIDEO OUT terminal (75 ohm terminated) • TP106 (PB, FM)
External trigger	(E)	• TP111 (D.FF)
Adjustment part	(F)	• Jig RCU: Code "43-5A"
Specified value	(G)	• 6.5 ± 0.5H
Adjustment tool	(H)	• Jig RCU [PTU94023B]

- (1) Play back the signal (A1) of the alignment tape (A2).
- (2) Apply the external trigger signal to D.FF (E) to observe the VIDEO OUT waveform and V.PB FM waveform at the measuring points (D1) and (D2).
- (3) Set the VCR to the manual tracking mode.
- (4) Adjust tracking so that the V.PB FM waveform becomes maximum.
- (5) Set the VCR to the Auto adjust mode by transmitting the code (F) from the Jig RCU. When the VCR enters the stop mode, the adjustment is completed.
- (6) If the VCR enters the eject mode, repeat steps (1) to (5) again.
- (7) Play back the alignment tape (A2) again, confirm that the switching point is the specified value (G).

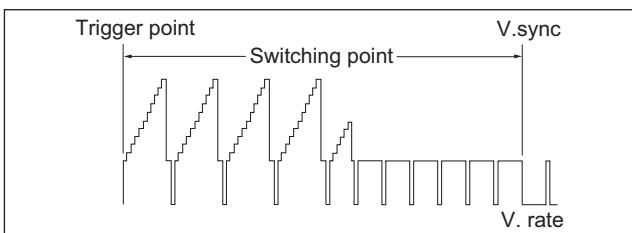

Fig.4-3a Switching point

##### 4.3.1.2 Slow tracking preset

Signal	(A1) (A2)	• Ext. input • Color (colour) bar signal [PAL]
Mode	(B1) (B2)	• VHS SP • VHS LP
Measuring point	(D)	• TV-Monitor
Adjustment part	(F)	• Jig RCU: Code "43-71" or "43-72"
Specified value	(G)	• minimum noise
Adjustment tool	(H)	• Jig RCU [PTU94023B]

- (1) Record the signal (A2) in the mode (B1), and play back the recorded signal.
- (2) Set the VCR to the manual tracking mode.
- (3) Set the VCR to the FWD slow (+1/6x) mode.
- (4) Transmit the code (F) from the Jig RCU to adjust so that the noise bar becomes the specified value (G) on the TV monitor in the slow mode.
- (5) Set the VCR to the Stop mode.
- (6) Confirm that the noise bar is (G) on the TV monitor in the slow mode.
- (7) Repeat steps (3) to (6) in the REV slow (+1/6x) mode.
- (8) Repeat steps (1) to (7) in the mode (B2).

#### Note:

- For FWD slow (+1/6x) playback, transmit the code "43-08" from the Jig RCU to enter the slow playback mode, and transmit the code "43-D0" for REV slow (-1/6x) mode.

#### 4.3.2 Syscon circuit

##### 4.3.2.1 Timer clock

Signal	(A)	• No signal
Mode	(B)	• EE
Equipment	(C)	• Frequency counter
Measuring point	(D1) (D2) (D3)	• IC3001 pin 61 • IC3001 pin 24 • C3026 + and -
Adjustment part	(F)	• C3025 (TIMER CLOCK)
Specified value	(G)	• 1024.008 ± 0.01 Hz (976.5549 ± 0.0010 usec)

- (1) Connect the frequency counter to the measuring point (D1).
- (2) Connect the short wire between the short point (D2) and Vcc (5V).
- (3) Short the leads of capacitor (D3) once in order to reset the microprocessor of the Syscon.
- (4) Disconnect the short wire between the short point (D2) and Vcc then connect it again.
- (5) Adjust the Adjustment part (F) so that the output frequency becomes the specified value (G).

## SECTION 5 TROUBLESHOOTING

### 5.1 Manually removing the cassette tape

If you cannot remove the cassette tape which is loaded because of any electrical or mechanical failures, manually remove it by taking the following steps.

- (1) Unplug the power cord plug from the power outlet.
- (2) Refer to the disassembly procedure of the unit and perform the disassembly of the major parts before removing the mechanism assembly. (See Fig. 5-1a)

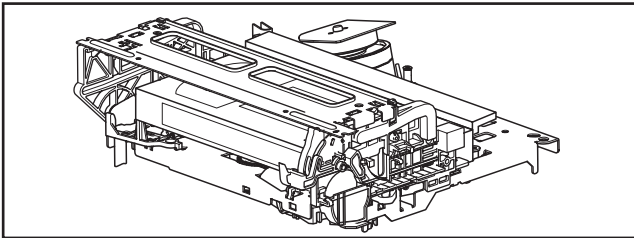

Fig.5-1a

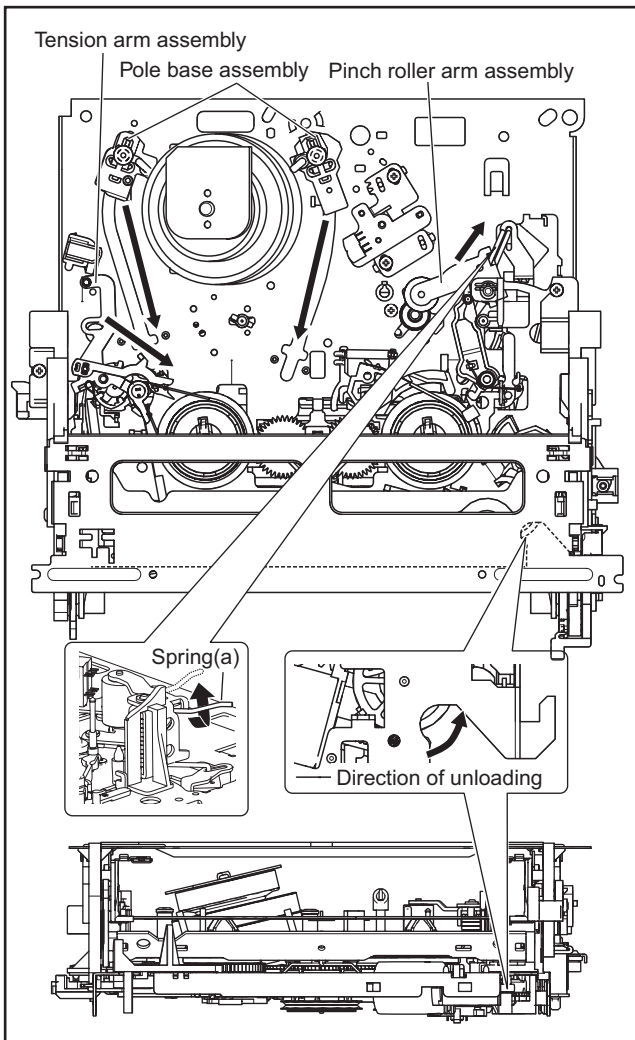

Fig.5-1b

- (3) Unload the pole base assembly by manually turning the gear of the loading motor until the pole base assembly is hidden behind the cassette lid. In doing so, hold the tape by the hand to keep the slack away from any grease. (See Fig.5-1b )

**In case of mechanical failures, while keeping the ten-**

**sion arm assembly free from tension, pull out the tape on the pole base assembly. Take the spring(a) of the pinch roller arm assembly off the hook, and detach it from the tape.**

- (4) Remove the screw (a) of the side frame (L/R).
- (5) Hold the slack tape and cassette cover together, lift the cassette tape, top frame, cassette holder and side frames (L, R) together from the rear and remove them by dis-engaging the hooks (a) and (b).

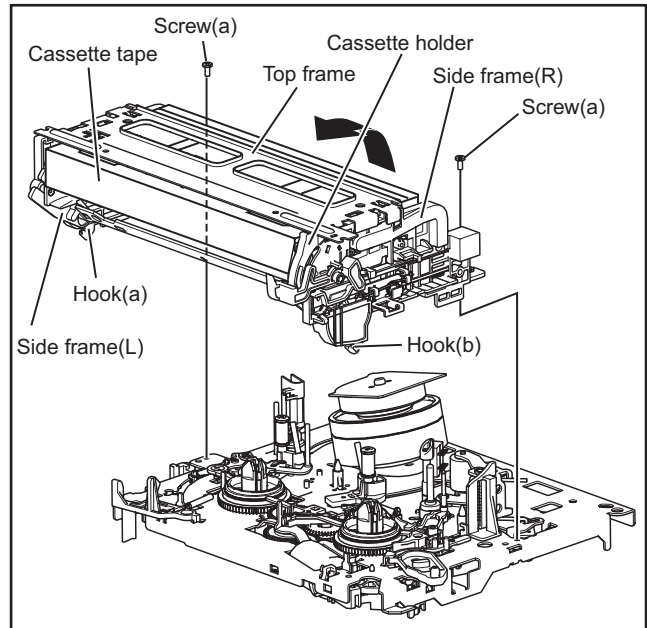

Fig.5-1c

- (6) Take up the slack of the tape into the cassette. This completes removal of the cassette tape.

### 5.2 Manually removing the disk(DVD/CD)

If you cannot remove the disk which is loaded because of any electrical or mechanical failures, manually remove it by taking the following steps.

#### 5.2.1 Method 1

- (1) AC Plug is pulled out at once and inserted again.
- (2) It is displayed on FDP as "PLEASE" and "WAIT" alternately, and while it blinks, pushing the OPEN/CLOSE button is continued.
- (3) After a while, a tray opens (About 20 seconds).
- (4) After removed a disk, press the OPEN/CLOSE button again to close the tray. The tray closes at about five seconds.
- (5) The "PLEASE" and "WAIT" alternately blink display of FDP disappears and it will be in a standby mode.
- (6) If the POWER button is pushed, it will usually be operating.

#### 5.2.2 Method 2

- (1) Unplug the AC power cord from the AC outlet.
- (2) Remove the top cover and front panel assembly. (Refer to the disassembly procedure and perform the dis-assembly of the major parts before removing)
- (3) Pass a thin wire through a hole in the DVD unit.
- (4) The disc tray comes out slightly. Take out the disc tray manually. (See Fig.5-2a)

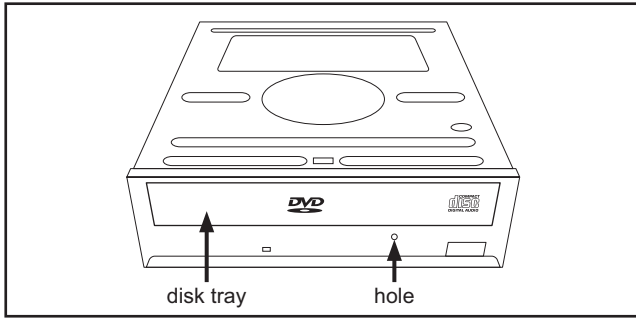

Fig.5-2a

### 5.3 Emergency display function (VHS SECTION)

This unit saves details of the last two emergencies as the EMG history and allows the status of the unit and the mechanism of each emergency to be shown both on the display and as OSD information.

When using the emergency function, it is required to set the unit to the Jig RCU mode.

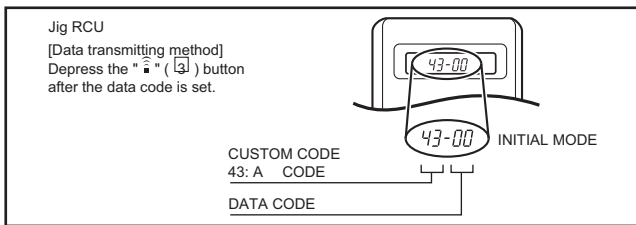

Fig.5-3a Jig RCU [PTU94023B]

#### 5.3.1 Displaying the EMG information

The EMG detail of information can be displayed by transmitting the code "43-59" from the Jig RCU.

##### Note:

- Press VHS/HDD/DVD SELECT button on the unit repeatedly first so that the VHS lamp lights up on the unit.
- The EMG detail information < 1 > < 2 > show the information on the latest EMG. It becomes " - : - : - : - " when there is no latest EMG record.

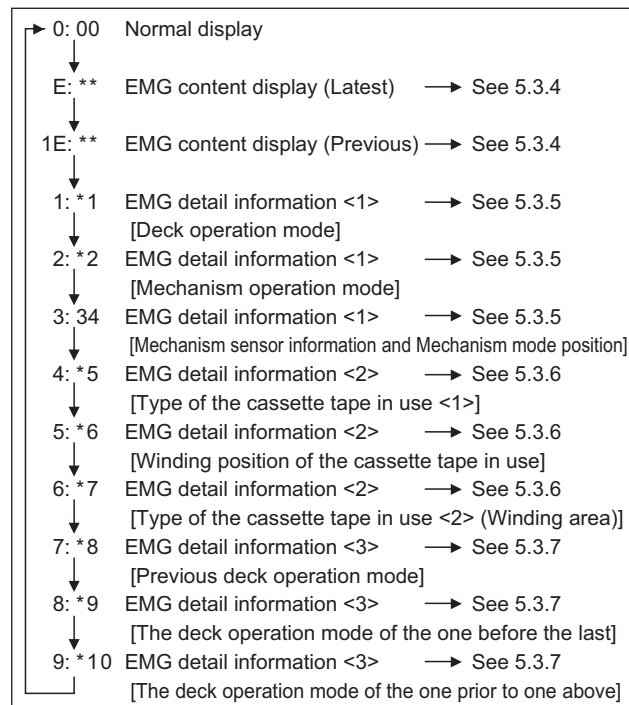

EMG display of 7 FDP display model

Fig.5-3b

#### EMG display of FDP display mode

- (1) Transmit the code "43-59" from the Jig RCU.

The FDP shows the EMG content in the form of "E:\*\*:\*\*".

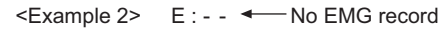
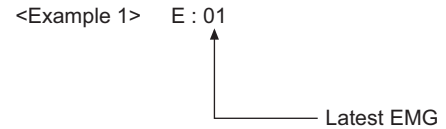

- (2) Transmit the code "43-59" from the Jig RCU again. The FDP shows the EMG detail information < 1 > in the form of "\*1 : \*2 : 34".

- \*1 : Deck operation mode at the moment of EMG
- \*2 : Mechanism operation mode at the moment of EMG
- 3- : Mechanism sensor information at the moment of EMG
- 4 : Mechanism mode position at the moment of EMG

- (3) Transmit the code "43-59" from the Jig RCU once again. The FDP shows the EMG detail information < 2 > in the form of "\*5 : \*6 : \*7".

- \*5 : Type of the cassette tape in use < 1 > .
- \*6 : Winding position of the cassette tape in use
- \*7 : Type of the cassette tape in use < 2 > (Winding area)

- (4) Transmit the code "43-59" from the Jig RCU once again. The FDP shows the EMG detail information < 3 > in the form of "\*8 : \*9 : \*10".

- \*8 : Previous deck operation mode at the moment of EMG
- \*9 : The deck operation mode of the one before the last at the moment of EMG
- \*10: The deck operation mode of the one prior to one above at the moment of EMG

- (5) Transmit the code "43-59" from the Jig RCU once again to reset the display.

#### 5.3.2 Clearing the EMG history

- (1) Display the EMG history.
- (2) Transmit the code "43-36" from the Jig RCU.
- (3) Reset the EMG display.

#### 5.3.3 Details of the OSD display in the EMG display mode

During the EMG display, the OSD shows the data on the deck mode, etc. The details of the display contents are as follows.

##### Notes:

- The display is variable depending on the part No. of the System Control microcomputer (IC3001) built into the VCR. In the following, refer to the figure carrying the same two characters as the top two characters of the part number of your IC.
- The sensor information in the OSD display contents is partially different from the mechanism sensor information in EMG detail information < 1 >.

[For MN\* only]

AA	BB	CC	DD	EE
FF	GG	HH	II	JJ
KK	LL	MM	NN	OO
PP	QQ	RR	SS	TT
UU	VV	WW	XX	YY

- AA : Deck operation mode (See EMG detail information < 1 >.)
- BB : Mechanism operation mode  
(See EMG detail of information < 1 >.)
- CC : Mechanism transition flag
- DD : Capstan motor control status
- EE : Loading motor control status
- FF : Sensor information (See sensor information details.)
- GG : Capstan motor speed
- HH : Key code (JVC code)
- II : Supply reel winding diameter data higher 8 bits.
- JJ : Supply reel winding diameter data lower 8 bits.
- KK : Mechanism sensor information & mechanism mode position(See EMG detail of information < 1 >.)
- LL : Tape speed data higher 8 bits.
- MM : Tape speed data lower 8 bits.
- NN : Cassette tape type < 2 > higher 8 bits.  
(See EMG detail of information < 2 >.)
- OO : Cassette tape type < 2 > lower 8 bits.  
(See EMG detail of information < 2 >.)
- PP : General data display area
  
- YY : General data display area

**\*FF:Sensor information details**

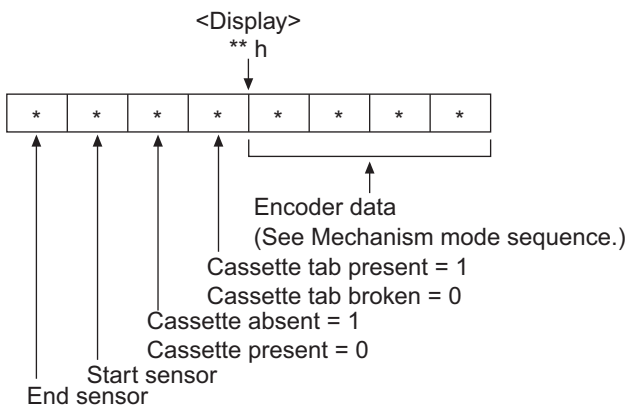

**[For \*HD only]**

AA	BB	CC
DD	EE	FF
GGGG	HHHH	
II	JJJJ	
KKKK	LLLL	MMMM
ROM No.		

- AA : Key code (JVC code)
- BB : Deck operation mode(See EMG detail information < 1 >.)
- CC : Mechanism operation mode (See EMG detail information < 1 >.)
- DD : Sensor information (See sensor information details.)
- EE : Capstan motor speed (Search, double speed)
- FF : Tracking value
- GGGG : Cassette tape type < 2 >, 16 bits.  
(See EMG detail information < 2 >.)
- HHHH : Supply reel winding diameter data
- II : Capstan motor speed (FF/REW, double speed)
- JJJJ : Tape speed data, lower 8 bits.
- KKKK : General data display area
- LLLL : General data display area
- MMMM : General data display area

**\*DD:Sensor information details**

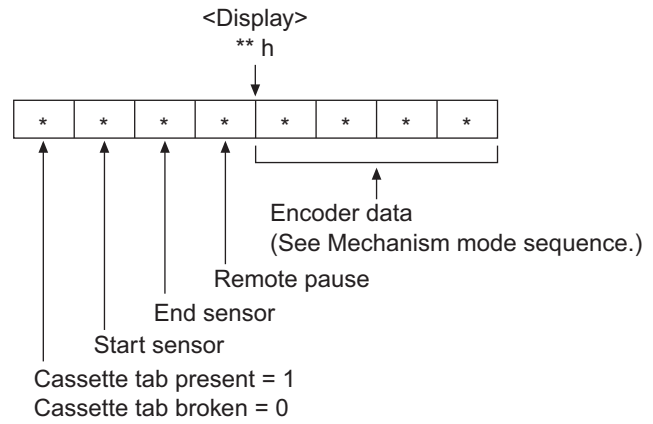

**[For both MN\*/HD\*]  
Mechanism mode sequence**

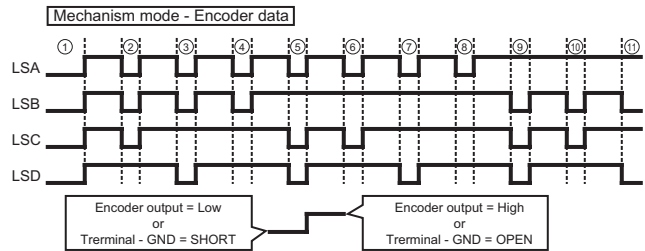

No.	Position	Encoder data
①	EJECT	0 h = 0000
②	EJECT1	1 h = 0001
③	EJECT2	2 h = 0010
④	ULSTOP	3 h = 0011
⑤	UPPER	4 h = 0100
⑥	ONSTOP(PLAY)	5 h = 0101
⑦	FWD/SS	6 h = 0110
⑧	REV/SS	7 h = 0111
⑨	OFFSTOP	8 h = 1000
⑩	FFREW-BRAKE	9 h = 1001
⑪	FFREW	A h = 1010
⑫	MIDDLE	F h = 1111

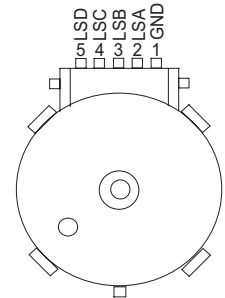



### 5.3.4 EMG content description

**Note:**

**EMG contents "E09" are for the model with Dynamic Drum (DD).**

FDP	CONTENT	CAUSE
E01: Loading EMG	If the mechanism mode does not change to the next mode within 4 seconds after the loading motor starts rotating in the loading direction, while the mechanism is in the after-loading position (with the tape up against the pole base), [E:01] is identified and the power is switched OFF. However, if the tape loading is not completed within 4 seconds after the loading motor starts rotating in the loading direction, the tape is simply unloaded and ejected. No EMG data is recorded in this case.	<ol style="list-style-type: none"> <li>The mechanism is locked in the middle of the mode transition during a tape loading operation.</li> <li>The mechanism overruns during the tape loading operation because the SYSCON cannot recognize the mechanism mode normally. This problem is due to a cause such as a rotary encoder failure.</li> <li>Power is not supplied to the loading MDA. (M12V/Vcc/Vref/ICP are disconnected in the middle.)</li> </ol>
E02: Unloading EMG	When the mechanism mode cannot be changed to another mode even when the loading motor has rotated for more than 4 seconds in the unloading direction, [E:02] is identified and the power is turned off.	<ol style="list-style-type: none"> <li>The mechanism is locked in the middle of mode transition.</li> <li>Without an eject signal being sent from the SYSCON, unloading is attempted (i.e. Ejection is attempted while the tape is still inside the mechanism.) because the SYSCON cannot recognize the mechanism mode normally. This is due to a cause such as a rotary encoder failure. (Mechanism position: UPPER)</li> <li>Power is not supplied to the loading MDA. (M12V/Vcc/Vref/ICP are disconnected in the middle.)</li> </ol>
E03: Take Up Reel Pulse EMG	When the falling edge of the take-up reel pulse has not been generated for more than 4 seconds in the capstan rotating mode, [E:03] is identified, the pinch rollers are turned off and stopped, and the power is turned off. In this case, however, the mechanism should be in position after tape loading. Note that the reel EMG is not detected during Slow/Frame advance operations.	<ol style="list-style-type: none"> <li>The take-up reel pulse is not generated in the FWD transport modes (PLAY/FWD SEARCH/FF, etc.) because; <ol style="list-style-type: none"> <li>The idler gear is not meshed with the take-up reel gear because the mechanism mal-functions for some reason.</li> <li>The idler gear is meshed with the take-up reel gear, but incapable of winding due to too large mechanical load (abnormal tension);</li> <li>The reel is rotating normally but an FG pulse is not generated due to the take-up reel sensor failure.</li> </ol> </li> <li>The supply reel pulse is not generated in the REV transport modes (REV SEARCH/REW, etc.) because; <ol style="list-style-type: none"> <li>The idler gear is not meshed with the supply reel gear because the mechanism mal-functions for some reason.</li> <li>The idler gear is meshed with the supply reel gear, but incapable of winding due to too large a mechanical load (abnormal tension);</li> <li>The reel rotates normally but the FG pulse is not generated due to a supply reel sensor failure.</li> </ol> </li> <li>Power(SW5V) is not supplied to the reel sensor on the tape winding side.</li> </ol>
E04: Drum FG EMG	When the drum FG pulse has not been input for more than 3 seconds in the drum rotating mode, [E:04] is identified, the pinch rollers are turned off and stopped, and the power is turned off.	<ol style="list-style-type: none"> <li>The drum could not start or the drum rotation has stopped due to too large a load on the tape, because; <ol style="list-style-type: none"> <li>The tape tension is abnormally high;</li> <li>The tape is damaged or a foreign object (grease, etc.) adheres to the tape.</li> </ol> </li> <li>The drum FG pulse did not reach the System controller CPU because; <ol style="list-style-type: none"> <li>The signal circuit is disconnected in the middle;</li> <li>The FG pulse generator (hall device) of the drum is faulty.</li> </ol> </li> <li>The drum control voltage (DRUM CTL V) is not supplied to the MDA.</li> <li>Power (M12V) is not supplied to the drum MDA.</li> </ol>
E05: Cassette Eject EMG	If the cassette does not reach the eject position within about 0.7 seconds after the cassette housing has started the cassette ejection operation, [E:05] is identified, the drive direction is reversed to load the tape, the mode is switched to STOP mode with the pinch roller OFF, and the power is switched OFF. During the cassette insertion process, the drive direction is reversed and the cassette is ejected if the tape is not up against the pole base within about 3 seconds after the start of the cassette pulling-in operation. If the cassette does not reach the eject position within about 0.7 seconds after the drive mode reversal operation, [E:05] is identified and the power is switched OFF immediately.	<ol style="list-style-type: none"> <li>The cassette cannot be ejected due to a failure in the drive mechanism of the housing.</li> <li>When the housing load increases during ejection, the loading motor is stopped because of lack of headroom in its drive torque. <ul style="list-style-type: none"> <li>Housing load increasing factors: Temperature environment (low temperature, etc.), mechanism wear or failure.</li> </ul> </li> <li>The sensor/switch for detecting the end of ejection are not functioning normally.</li> <li>The loading motor drive voltage is lower than specified or power (M12V) is not supplied to the motor (MDA).</li> <li>When the user attempted to eject a cassette, a foreign object (or perhaps the user's hand) was caught in the opening of the housing.</li> </ol>
E06: Capstan FG EMG	When the capstan FG pulse has not been generated for more than 1 second in the capstan rotating mode, [E:06] is identified, the pinch rollers are turned off and stopped, and the power is turned off. However, the capstan EMG is not detected in SLOW/STILL modes. Note that, if the part number of the System Control IC begins with "MN" or "M3", the capstan EMG is not detected even during the FF/REW operation.	<ol style="list-style-type: none"> <li>The capstan could not start or the capstan rotation has stopped due to too large a load on the tape, because; <ol style="list-style-type: none"> <li>The tape tension is abnormally high (mechanical lock);</li> <li>The tape is damaged or a foreign object (grease, etc.) is adhered to the tape (occurrence of tape entangling, etc.).</li> </ol> </li> <li>The capstan FG pulse did not reach the System controller CPU because; <ol style="list-style-type: none"> <li>The signal circuit is disconnected in the middle;</li> <li>The FG pulse generator (MR device) of the capstans is faulty.</li> </ol> </li> <li>The capstan control voltage (CAPSTAN CTL V) is not supplied to the MDA.</li> <li>Power (M12V, SW5V) are not supplied to the capstan MDA.</li> </ol>
E07: SW Power Short-Circuit EMG	When short-circuiting of the SW power supply with GND has lasted for 0.5 second or more, [E:07] is identified, all the motors are stopped and the power is turned off.	<ol style="list-style-type: none"> <li>The SW 5 V power supply circuit is shorted with GND.</li> <li>The SW 12 V power supply circuit is shorted with GND.</li> </ol>
E08: DVD EMG	When communication with a system computer of VHS side is not carried out because of the defective DVD unit, or when the DVD unit must be reset	<ol style="list-style-type: none"> <li>The DVD unit is defective.</li> <li>Contact failure of the wires in the DVD unit or VHS side.</li> </ol>
E09: DD FG EMG	When the DD FG pulse is not generated within 2.5 seconds, [E:09] is identified, the tilt motor is stopped and the power is turned off.	<ol style="list-style-type: none"> <li>The FG sensor is defective. (The soldered parts have separated.)</li> <li>The pull-up resistor at the FG sensor output is defective. (The soldered parts have separated.)</li> <li>Contact failure or soldering failure of the pins of the connector (board-to-board) to the FG sensor.</li> <li>The power (5V) to the sensor is not supplied. (Connection failure/soldering failure)</li> <li>The FG pulse is not sent to the System Controller CPU.</li> <li>The tilt motor is defective. (The soldered parts have separated.)</li> <li>The drive power to the tilt motor is not supplied. (Connection failure/soldering failure)</li> <li>The tilt motor drive MDA - IC is defective.</li> <li>Auto-recovery of the DD tilting cannot take place due to overrun.</li> </ol>
E0A: Supply Reel Pulse EMG	When the falling edge of the supply reel pulse has not been generated for more than 10 seconds in the capstan rotating mode, [E:0A] is identified and the cassette is ejected (but the power is not turned off). In this case, however, the mechanism should be in the position after tape loading (with the tape up against the pole base). Also note that the reel EMG is not detected during Slow/Frame advance operations.	<ol style="list-style-type: none"> <li>The supply reel pulse is not generated in the FWD transport mode (PLAY/FWD SEARCH/FF, etc.) because; <ol style="list-style-type: none"> <li>PLAY/FWD or SEARCH/FF is started while the tape in the inserted cassette is cut in the middle;</li> <li>A mechanical factor caused tape slack inside and outside the supply reel side of the cassette shell. In this case, the supply reel will not rotate until the tape slack is removed by the FWD transport, so the pulse is not generated until then;</li> <li>The reel is rotating normally but the FG pulse is not generated due to a supply reel sensor failure.</li> </ol> </li> <li>The take-up reel pulse is not generated in the REV transport mode (REV SEARCH/REW, etc.). <ol style="list-style-type: none"> <li>REV SEARCH/REW is started when the tape in the inserted cassette has been cut in the middle;</li> <li>A mechanical factor caused tape slack inside and outside the take-up reel side of the cassette shell. In this case, the take up will not rotate until the tape slack is removed by the REV transport, so the pulse will not be generated until that time;</li> <li>The reel is rotating normally but the FG pulse is not generated due to a take-up reel sensor failure.</li> </ol> </li> <li>The power (SW 5V) to a reel sensor is not supplied.</li> </ol>
EU1: Head clog warning history	Presupposing the presence of the control pulse output in the PLAY mode, when the value obtained by mixing the two V.FM output channels (without regard to the A.FM output) has remained below a certain threshold level for more than 10 seconds, [E:U1] is identified and recorded in the emergency history. During the period in which the head clog is detected, the FDP shows "U:01" and the OSD repeats the "3 seconds of warning display" and the "7 seconds of noise picture display" alternately. EMG code : "E:C1" or "E:U1" / FDP : "U:01" / OSD : "Try cleaning tape." or "Use cleaning cassette." The head clog warning is reset when the above-mentioned threshold has been exceeded for more than 2 seconds or the mode is changed to another mode than PLAY.	

### 5.3.5 EMG detail information < 1 >

The status (electrical operation mode) of the VCR and the status (mechanism operation mode/sensor information) of the mechanism in the latest EMG can be confirmed based on the figure in EMG detail information < 1 > .

[FDP/OSD display] \*1 : \*2 : 34

- \*1 : Deck operation mode at the moment of EMG
- \*2 : Mechanism operation mode at the moment of EMG
- 3- : Mechanism sensor information at the moment of EMG
- 4 : Mechanism mode position at the moment of EMG

#### Note:

- For EMG detailed information < 1 >, the content of the code that is shown on the display (or OSD) differs depending on the parts number of the system control microprocessor (IC3001) of the VCR. The system control microprocessor parts number starts with two letters, refer these to the corresponding table.

#### \*1 : Deck operation mode

[Common table of MN\* and HD]

Display		Deck operation mode
MN*	HD*	
00	-	Mechanism being initialized
01	00	STOP with pinch roller pressure off (or tape present with P.OFF)
02	01	STOP with pinch roller pressure on
03	-	POWER OFF as a result of EMG
04	04	PLAY (Normal playback)
0C	0E	REC
10	11	Cassette ejected
20	22	FF
21	-	Tape fully loaded, START sensor ON, short FF
22	-	Cassette identification FWD SEARCH before transition to FF (SPx7-speed)
24	26	FWD SEARCH (variable speed) including x2-speed
2C	2E	INSERT REC
40	43	REW
42	-	Cassette identification REV SEARCH before transition to REW (SPx7-speed)
44	47	REV SEARCH (variable speed)
4C	4C	AUDIO DUB
6C	6E	INSERT REC (VIDEO + AUDIO)
84	84	FWD STILL / SLOW
85	85	REV STILL / SLOW
8C	8F	REC PAUSE
8D	-	Back spacing
8E	-	Forward spacing (FWD transport mode with BEST function)
AC	AF	INSERT REC PAUSE
AD	-	INSERT REC back spacing
CC	CD	AUDIO DUB PAUSE
CD	-	AUDIO DUB back spacing
EC	EF	INSERT REC (VIDEO + AUDIO) PAUSE
ED	-	INSERT REC (VIDEO + AUDIO) back spacing

### \*2 : Mechanism operation mode

[Table of MN\*]

Display	Mechanism operation mode
00	Command standby (No command to be executed)
01	Immediate Power OFF after EMG occurrence
02	Loading from an intermediate position during mechanism initialization
03	Unloading due to EMG occurrence during mechanism initialization
04	Ejecting cassette (ULSTOP to EJECT)
05	Inserting cassette (EJECT to ULSTOP)
06	Loading tape (ULSTOP to PLAY)
07	Unloading tape (PLAY to ULSTOP)
08	Transition from pinch roller ON to STOP
09	Transition from pinch roller OFF to STOP (PLAY to OFFSTOP)
0A	Transition from pinch roller OFF to STOP at power OFF
0B	Transition from pinch roller ON to STOP at power ON
0C	Transition to PLAY
0D	Transition to Search FF
0E	Transition to REC
0F	Transition to FWD STILL/SLOW
10	Transition to REV STILL/SLOW
11	Transition to Search REV
12	Transition from FF/REW to STOP
13	Transition to FF
14	Transition to REW
15	Tape end detection processing during loading
16	Short FWD/REV at tape sensor ON during unloading
17	Transition to FF/REW brake mode

[Table of HD\*]

Display	Mechanism operation mode
00	STOP with pinch roller pressure off
01	STOP with pinch roller pressure on
02	U/L STOP (or tape being loaded)
04	PLAY (Normal playback)
05	PLAY (x1-speed playback using JOG)
0E	REC
11	Cassette ejected
22	FF
26	FWD SEARCH (variable speed) including x2-speed
2E	INSERT REC
43	REW
47	REV SEARCH
4C	AUDIO DUB
6E	INSERT REC (VIDEO + AUDIO)
84	FWD STILL/SLOW
85	REV STILL/SLOW
8F	REC PAUSE
AF	INSERT REC PAUSE
C7	REV SEARCH (x1-speed reverse playback using JOG)
CD	AUDIO DUB PAUSE
EF	INSERT REC (VIDEO + AUDIO) PAUSE
F0	Mechanism being initialized
F1	POWER OFF as a result of EMG
F2	Cassette being inserted
F3	Cassette being ejected
F4	Transition from STOP with pinch roller pressure on to STOP with pinch roller pressure off
F5	Transition from STOP with pinch roller pressure on to PLAY
F6	Transition from STOP with pinch roller pressure on to REC
F7	Cassette type detection SEARCH before FF/REW is being executed
F8	Tape being unloaded
F9	Transition from STOP with pinch roller pressure off to STOP with pinch roller pressure on
FA	Transition from STOP with pinch roller pressure off to FF/REW
FB	Transition from STOP with pinch roller pressure off to REC.P (T.REC,etc.)
FC	Transition from STOP with pinch roller pressure off to cassette type detection SEARCH
FD	Short REV being executed after END sensor on during unloading
FE	Tension loosening being executed after tape loading (STOP with pinch roller pressure on)
FF	Tape being unloaded

### 3- : Mechanism sensor information

[Common table of MN\* and HD\*]

Display	Mechanism sensor information			
	REC safety SW	Start sensor	End sensor	Mechanism position sensor
0-	Tab broken	ON	ON	ON
1-	Tab broken	ON	ON	OFF
2-	Tab broken	ON	OFF	ON
3-	Tab broken	ON	OFF	OFF
4-	Tab present	OFF	ON	ON
5-	Tab present	OFF	ON	OFF
6-	Tab present	OFF	OFF	ON
7-	Tab present	OFF	OFF	OFF
8-	Tab broken	ON	ON	ON
9-	Tab broken	ON	ON	OFF
A-	Tab broken	ON	OFF	ON
B-	Tab broken	ON	OFF	OFF
C-	Tab present	OFF	ON	ON
D-	Tab present	OFF	ON	OFF
E-	Tab present	OFF	OFF	ON
F-	Tab present	OFF	OFF	OFF

Tab broken = 0      Sensor ON = 0      Sensor ON = 0  
 Tab present = 1      sensor OFF = 1      Sensor OFF = 1

### -4 : Mechanism mode position

[Common table of MN\* and HD\*]

Mechanism sensor information	Display	Deck operation mode	
Even number (0, 2, 4, 6, 8, A, C, E)	-0	Not established	
	-1	EJECT	EJECT position
	-2	EJECT-EJECT1	Intermodal position
	-3	EJECT1	EJECT1 position
	-4	EJECT1-EJECT2	Intermodal position
	-5	EJECT2	EJECT2 position
	-6	EJECT2-ULSTOP	Intermodal position
	-7	ULSTOP	ULSTOP position
	-8	ULSTOP-UPPER	Intermodal position
	-9	UPPER	Loading (unloading) tape
	-A	UPPER-ONSTOP	Intermodal position
	-B	ONSTOP	PLAY position
	-C	PLAY-FWD/SS	Intermodal position
	-D	FWD/SS	FWD (FWD Still/Slow) position
	-E	FWD/SS-REV	Intermodal position
-F	REV	REV (REV Still/Slow) position	
Odd number (1, 3, 5, 7, 9, B, D, F)	-0	REV-OFFSTOP	Intermodal position
	-1	OFFSTOP	Pinch roller OFF position
	-2	OFFSTOP-FFREWB	Intermodal position
	-3	FFREWB	FF/REW Brake position
	-4	FFREWB-FFREW	Intermodal position
-5	FFREW	FF/REW position	

#### 5.3.6 EMG detail information < 2 >

The type of the cassette tape and the cassette tape winding position can be confirmed based on the figure in EMG detail information < 2 > .

Note:

- EMG detail information < 2 > is the reference information stored using the remaining tape detection function of the cassette tape. As a result, it may not identify cassette correctly when a special cassette tape is used or when the tape has variable thickness.

### \*5 : Cassette tape type < 1 >

Display	Cassette tape type <1>
00	Cassette type not identified
16	Large reel/small reel (T-0 to T-15/T-130 to T-210) not classified
82	Small reel, thick tape (T-120) identified/thin tape (T-140) identified
84	Large reel (T-0 to T-60) identified
92	Small reel, thick tape (T-130) identified/thin tape (T-160 to T-210) identified
93	Small reel, thick tape/C cassette (T-0 to T-100/C cassette) not classified
C3	Small reel, thick tape/C cassette (T-0 to T-100/C cassette) being classified
D3	Small reel, thick tape/C cassette (T-0 to T-100/C cassette) being classified
E1	C cassette, thick tape (TC-10 to TC-20) identified
E2	Small reel, thick tape (T-0 to T-100) identified
E9	C cassette, thin tape (TC-30 to TC-40) identified
F1	C cassette, thick tape/thin tape (TC-10 to TC-40) not classified

Notes:

- Cassette tape type < 1 > is identified a few times during mode transition and the identification count is variable depending on the cassette tape type. If an EMG occurs in the middle of identification, the cassette tape type may not be able to be identified.
- If other value than those listed in the above table is displayed, the cassette tape type is not identified.

### \*6 : Cassette tape winding position

The cassette tape winding position at the moment of EMG is displayed by dividing the entire tape (from the beginning to the end) in 21 sections using a hex number from "00" to "14".

00 : End of winding

14 : Beginning of winding

FF : Tape position not identified

### \*7 : Cassette tape type < 2 > (Winding area)

Display	Cassette tape type <2>	(Reference) Word data (Beginning) (End)
00	Cassette type not identified	
04 - 08	C cassette, thick tape TC-10	(0497 - 0506)(0732 - 0858)
05 - 06	Small reel, thick tape T-20	(05A9 - 0661)
05 - 0C	C cassette, thick tape TC-20P	(0599 - 05FF)(0AA1 - 0C07)
06 - 0C	C cassette, thin tape TC-40	(0623 - 063D)(0C41 - 0CC3)
06 - 0C	C cassette, thin tape TC-30	(0611 - 0638)(0C0C - 0CB2)
07 - 08	Small reel, thick tape T-40	(07CC - 08E5)
09 - 0B	Small reel, thick tape T-60	(09FD - 0B78)
0C - 0D	Small reel, thick tape T-80(DF-160)	(0C20 - 0DFC)
0D - 0F	Small reel, thick tape T-90(DF-180)	(0D31 - 0F3E)
0E - 10	Small reel, thick tape T-100	(0E43 - 107F)
10 - 12	Small reel, thin tape T-140	(10E1 - 120C)
10 - 13	Small reel, thick tape T-120(DF-240)	(1073 - 1313)
11 - 14	Small reel, thick tape T-130	(1185 - 1429)
12 - 14	Small reel, thin tape T-160	(12D3 - 141F)
13 - 14	Small reel, thin tape T-210(DF-420)	(1373 - 14C3)
13 - 14	Small reel, thin tape T-180(DF-360)	(1357 - 14C0)
13 - 14	Small reel, thin tape T-168	(1395 - 14EE)
13 - 14	Small reel, thick tape DF-300	(13A8 - 14CE)
15 - 16	Large reel T-20	(1536 - 1618)
16 - 17	Large reel T-30	(1647 - 175A)
17 - 18	Large reel T-40	(1759 - 189C)
19 - 1B	Large reel T-60	(1989 - 1B2F)

Note:

- The values of cassette tape type < 2 > in the above table are typical values with representative cassette tapes.

### 5.3.7 EMG detail information < 3 >

Three deck operation modes preceding the deck operation mode in which the EMG occurs may be confirmed based on the figures in the EMG information detail < 3 > . For the contents of the displayed information, see the table "Deck operation mode" in section "5.3.5 EMG detail information < 1 >".

## 5.4 Display function of DVD section

### 5.4.1 Displaying SYSTEM INFO

SYSTEM INFO contains information on firmware version of the unit and the mechanism drive, and an initialize execution menu.

- (1) Set the unit to the Jig RCU mode.
- (2) Press VHS/HDD/DVD SELECT button on the unit repeatedly so that the HDD lamp lights up on the unit.
- (3) Transmit "43-8b" from the Jig RCU.(Please end a setting menu pushing " SET UP" button of the remote control unit appended to the commodity beforehand when a setting menu is displayed.)
- (4) SYSTEM INFORMATION menu is displayed in the screen.
- (5) To move cursor in SYSTEM INFO, use the " ▲ ", " ▼ ", " ◀ ", and " ▶ " buttons of a remote control unit attached to product.
- (6) To quit the SYSTEM INFO menu, transmit "43-8b" from the Jig RCU..
- (7) Cancel Jig RCU mode.

#### The example of a display < Version Info 1 >

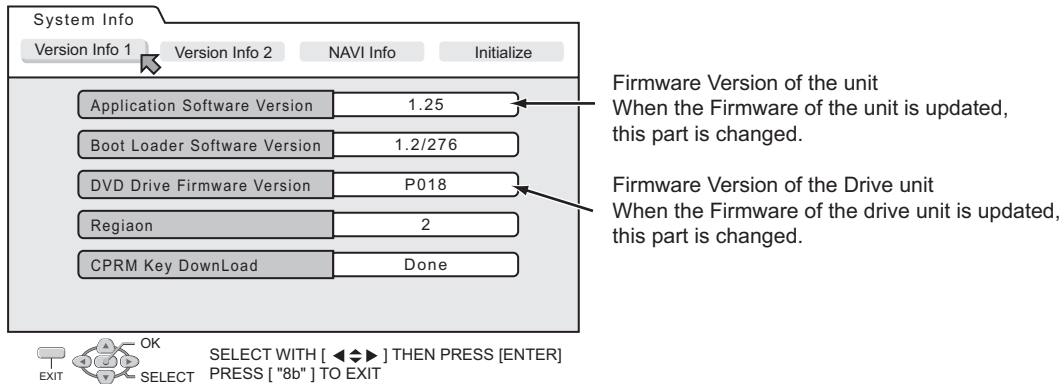

#### NOTE:

Items other than the ones described above are not used in service work.

### 5.4.2 Displaying the firmware version of the main body in the user mode

- The version information of the main body firmware can be displayed in the normal mode (user mode) without using the Jig mode.
- The version can be checked by the user operation when it is required to check the version when there are failure inquiries from the users.

- (1) Turn the power of the main body ON.
- (2) Press the "SET UP" button of the supplied remote control unit to display the setting menu screen.
- (3) Move the arrow to the "INITIAL SET UP" tab, keep pressing the "STOP" button of the main body for 10 seconds in that condition.
- (4) The screen changes to the display shown in the below diagram, and the firmware version of the main body is indicated.

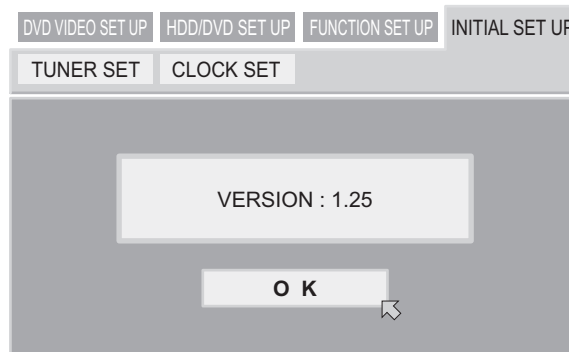

### 5.4.3 Updating the firmware of the unit

- Firmware update disc supports CD-R media.
- When firmware update is necessary, information is available from the website of DIGITAL VIDEO STORAGE CATEGORY, CS group.

#### 5.4.3.1 Creating an update disc

Please check the details of the update disc creation method by JS-NET.

- (1) Down load the update file from JS-NET.
  - (2) Write the update file into CD-R. Pay attention in the following points when writing the update disc.
- Make sure to write in "Disc at Once".
  - Set the file compatibility to "ISO9660 format". (ROMEO, JOLIET are disapproved.)  
If the writing method is not correct, the update results in an error.

#### 5.4.3.2 Update procedure

- There are two methods of updating firmware, using JIG RCU mode < method 1 > or not using JIG mode(User update mode) < method 2 >. Both methods can be used to update the firmware.

##### < Method 1 >

- (1) Set to the Jig RCU mode.
- (2) Press VHS/HDD/DVD SELECT button on the unit repeatedly so that the DVD lamp lights up on the unit.
- (3) Load the update disc on the tray, and then close the tray.
- (4) When the disc reading operation is completed, transmit "43-70" with the Jig remote control unit.  
If the update disc is not correct, FDP indicator displays an "ERROR" after transmitting "43-70". Transmit "43-70" once and make the FDP indicator to normal display, and then reload the disc then transmit "43-70" again.
- (5) "UPDATE" is displayed in the FDP indicator, and the FDP indicator changes to "FW UPDATE" afterwards. It takes approx. 2 minutes for the change.
- (6) Remove the disc as the tray is ejected, and then transmit "43-70" with the Jig remote control unit. Then the FDP indicator changes from "UPDATE" to the normal display.
- (7) Close the tray and turn the unit OFF. Pull out the power cord from the wall socket, then plug the power cord into the wall socket again.
- (8) When "PLEASE" and "WAIT" blink alternately in the FDP indicator disappears, turn the unit ON.
- (9) Display the SYSTEM INFO menu, and check the version of the firmware.
- (10) Cancel the Jig RCU mode.

##### < Method 2 >

- (1) Turn the power ON. Load the update disc on the tray and close the tray.  
Press VHS/HDD/DVD select button on the unit repeatedly so that the DVD lamp lights up on the unit.
- (2) When the disc reading operation is completed, Keep pressing the "STOP" button on the unit for 5 seconds.(Until FDP indicator changes to "UPDATE").
- (3) In approx. 2 minutes the tray is ejected. Remove the disc and close the tray.
- (4) Reset operation is carried out automatically, and it becomes standby condition.
- (5) Then, display the SYSTEM INFO menu in the Jig RCU mode and check the version.

### 5.4.4 Updating the firmware of the drive unit

- Firmware update disc supports only DVD-RAM media.
  - When firmware update is necessary, written discs are distributed by DIGITAL VIDEO STORAGE CATEGORY, CS group.
- (1) Turn the unit ON.
  - (2) Press VHS/HDD/DVD SELECT button on the unit repeatedly so that the DVD lamp lights up on the unit.
  - (3) Load the update DVD-RAM disc on the tray and close the tray.
  - (4) "READING" is displayed in the FDP indicator and the update is started.
  - (5) In a short while "READING" in the FDP indicator disappears, open the tray to remove the disc and close the tray.
  - (6) Turn the power OFF and pull out the power cord from the wall socket, then plug the power cord into the wall socket again.
  - (7) Set to the Jig RCU mode and check the firmware version of the drive.

#### 5.4.5 Exchanging the fitting

As the fitting that comes with the service drive unit cannot be used, make sure to attach a service fitting when the drive unit is exchanged. The fitting that is removed from the old drive unit can be attached to the new drive unit. The fitting can be removed by pulling upwards while opening out the lower part of the fitting outwards.

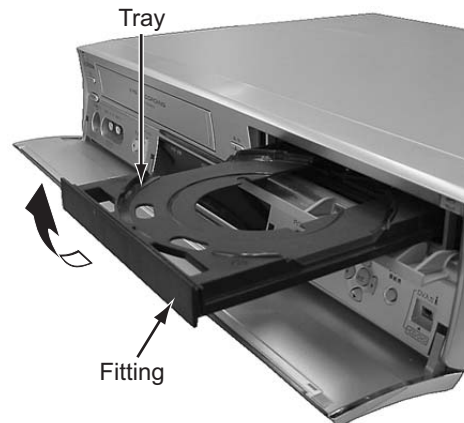

#### 5.4.6 Initialization to the factory shipment state

When the initialization is operated, internal information changes as follows. It is essential to obtain the client's permission before the operation.

- All DVD library is all deleted.
- All the DVD initial settings go back to the initial status.
  - (1) Set to the Jig RCU mode.
  - (2) Press VHS/HDD/DVD SELECT button on the unit repeatedly so that the DVD lamp lights up on the unit.
  - (3) Transmit "43-6F" with the Jig remote control unit.
  - (4) FDP indicator displays "FACTORY", and changes to "CHECK OK" after blinking for a short while.
  - (5) Pull out the power code from the wall socket.
  - (6) The Jig RCU mode is forced to cancel at the same time with the initialization, check whether the Jig RCU mode is canceled by plugging the power code into the wall socket again. (The colon ":" in time display should be continuously ON, not blinking.)  
If the Jig RCU mode is not canceled, transmit "43-9D" with Jig remote control unit to cancel the Jig RCU mode.

#### 5.4.7 Setting after the drive unit replacement

When the drive unit is replaced, it is necessary to set a region code. Service drive units for replacement are not set for any region code, and they are in an indefinite condition.

Make sure to set region code after attaching the drive unit to the unit.

**Without the setting of the region code, discs that have regions cannot be played back.**

##### 5.4.7.1 Creating a region setting disc.

Please check the details of the region setting disc creation method by JS-NET.

- (1) Download the region setting file from JS-NET.
- (2) Write the region setting file into CD-R. Pay attention in the following points when writing the file into CD-R.
  - Make sure to write in "Disc at Once".
  - Set the file compatibility to "ISO9660 format". (ROMEO, JOLIET are disapproved).If the writing method is not correct, the normal setting cannot be performed.

##### 5.4.7.2 Setting the region

- (1) Set for the Jig RCU mode.
- (2) Press VHS/HDD/DVD SELECT button on the unit repeatedly so that the DVD lamp lights up on the unit.
- (3) Load the region setting disc on the tray, and then close the tray.
- (4) When the disc reading operation is completed, transmit "43-70" with the Jig remote control unit.
- (5) FDP indicator changes to "UPDATE". Remove the disc as the tray will open for a few seconds.
- (6) Then, check whether the FDP indicator is "REGION 2", and then close the tray.
- (7) Turn the power OFF, and pull out the power code, and then plug the power code in again.
- (8) Cancel the Jig RCU mode.

#### 5.4.8 When it is displayed in FDP, 'RESETTING'

- When the following operations are carried out, "RESETTING" is displayed in the FDP of the main body.
  - (1) When the "POWER" button and the "STOP" button of the main body are pressed at the same time
  - (2) When the code "9B" is transmitted to the main body by using JIG remote control unit
  - (3) When transmission failure occurs between the main CPU and the DVD host CPU due to defect  
If "RESETTING" is displayed in the FDP after the power code is plugged into the outlet, check the followings.
- The peripheral circuitry of each microcomputer
- Whether the wire between the DVD drive and the board is properly connected
- Whether the wire between the main board and the digital board is properly connected





**JVC**

Victor Company of Japan, Limited  
DIGITAL VIDEO STORAGE CATEGORY 12, 3-chome, Moriya-cho, kanagawa-ku, Yokohama, kanagawa-prefecture, 221-8528, Japan

(No.YD084)



# PARTS LIST

[DR-MX10SE,DR-MX10SEF,DR-MX10SEK]

**\* SAFETY PRECAUTION**

Parts identified by the  $\triangle$  symbol are critical for safety. Replace only with specified part numbers.

**\* BEWARE OF BOGUS PARTS**

Parts that do not meet specifications may cause trouble in regard to safety and performance. We recommend that genuine JVC parts be used.

\* (x\_) in a description column shows the number of the used part.

**Area Suffix**

E	-----	Continental Europe Northern Europe
EF	-----	France
EK	-----	U.K.

**- Contents -**

Exploded view of general assembly and parts list	-----	3-2
VHS mechanism assembly and parts list	-----	3-6
Electrical parts list	-----	3-9
Packing materials and accessories parts list	-----	3-25

# Exploded view of general assembly and parts list

Block No. M1MM

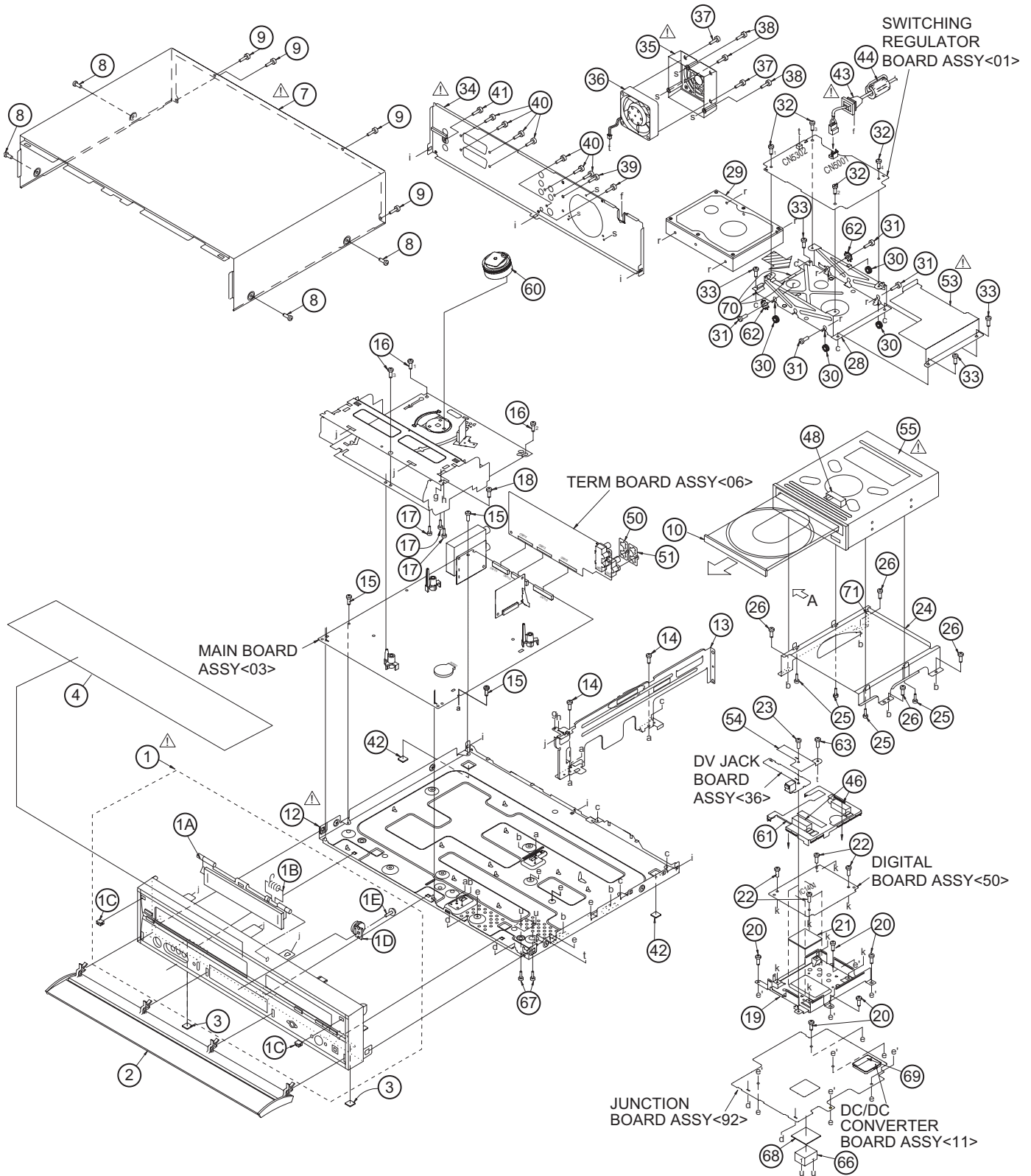

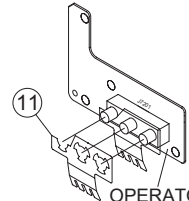
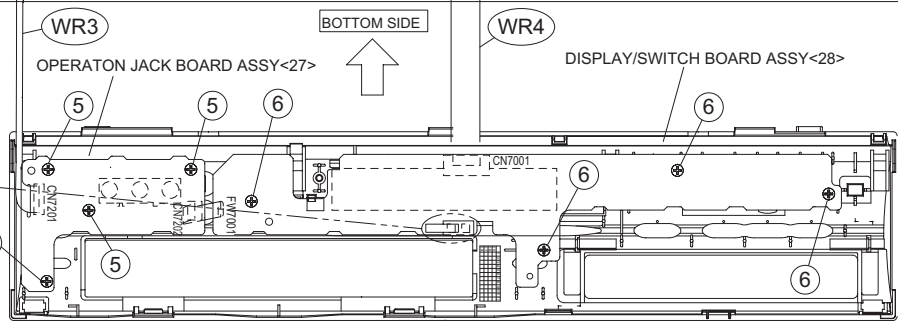
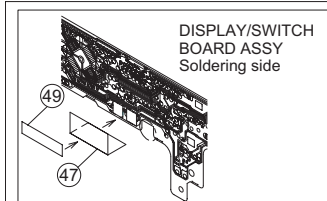
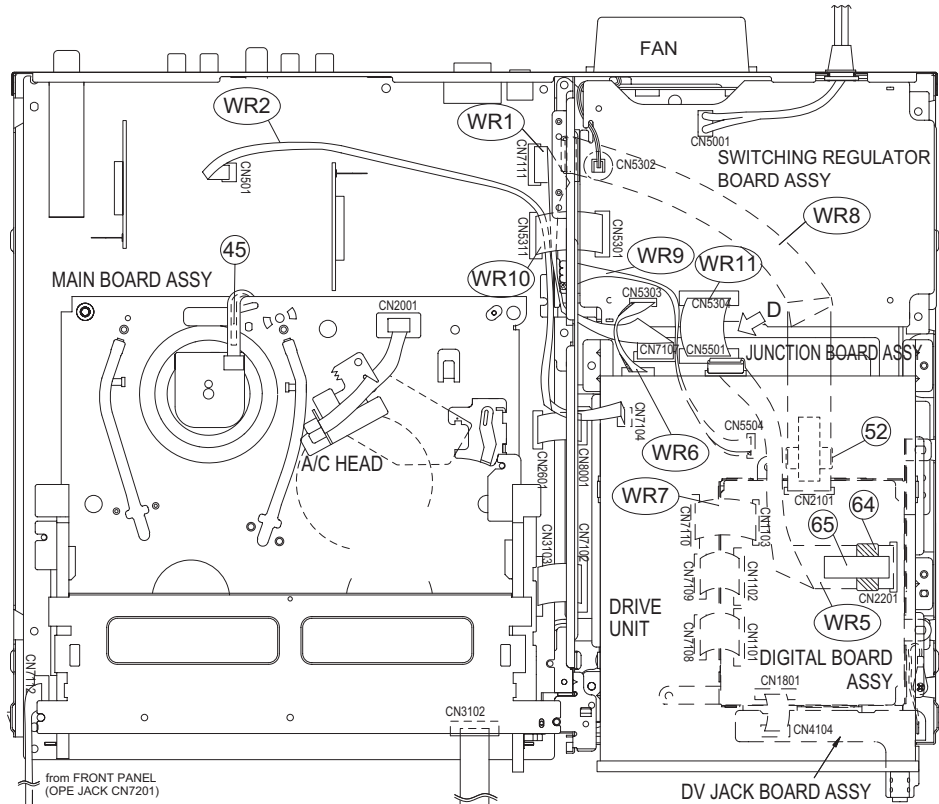
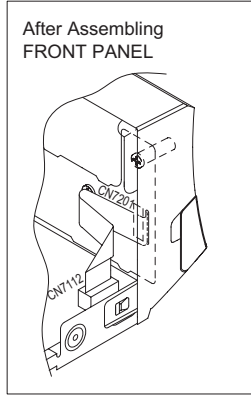

NOTE) INSERT FFC WIRE TO THE CONNECTOR BEFORE ATTACHING TO FRONT PANEL.

NOTE) WHEN YOU FIX ANY PWB WITH THE SCREW, PUT IT ON THE JIGS.

NOTE) Push down FERRITE CORE of DVD DRIVER ATAPI WIRE between DVD DRIVE and SW REG PWB as follows.

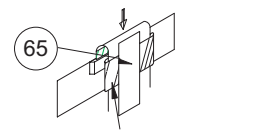

DRAWING FROM DIRECTION D

DRIVE UNIT REAR SIDE HDD REAR SIDE  
 NOTE) Push both ends of connector when it is inserted to DRIVE UNIT/HDD. Or, insert the connector evenly pushing the lead of part . When connector is removed, add power right and left evenly.

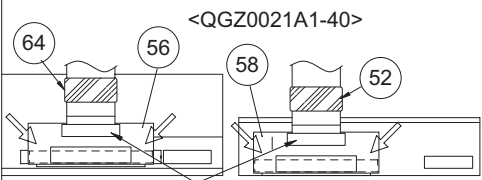

NOTE) Lock the connector after inserting FFC WIRE in the root of the connector.

NOTE) Lock the connector after inserting FFC WIRE in the root of the connector.

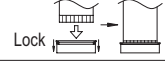

<HOW TO REMOVE>

NOTE) Replace the attached FITTING.

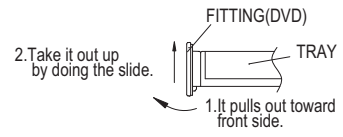

DRAWING FROM DIRECTION A

# General assembly

Block No. [M][1][M][M]

△ Symbol No.	Part No.	Part Name	Description	Local
△ 1	LP10594-002B	FRONT PANEL ASSY		
1A	LP21410-001A	CASSETTE DOOR		
1B	PQ46448	TORSION SPRING		
1C	QZW0063-001	MAGNET LATCH	(x2)	
1D	QZW0055-005	DAMPER		
1E	LP31491-001A	ASSY SCREW		
2	LP10596-003A	DOOR ASSY		E
2	LP10596-005A	DOOR ASSY		EF
2	LP10596-004A	DOOR ASSY		EK
3	LP31348-001A	FOOT	(x2)	
4	QPH00704705	POLY SHEET	DOOR	
5	QYTDSF2608ZA	TAP SCREW	OPERATON JACK (x4)	
6	QYTDSF2608ZA	TAP SCREW	DISPLAY/SWITCH(x4)	
△ 7	LP10460-020A	TOP COVER	(SERVICE)	
8	QYSBSG3006NA	TAP SCREW	TOP SIDE(x4)	
9	QYSBSG3006NA	TAP SCREW	TOP REAR(x4)	
10	LP21348-001B	FITTING(DVD)		
11	LP31337-002A	EARTH PLATE	FOR J7201	
△ 12	LP10525-002B	BOTTOM CHASSIS		
13	LP21406-001B	BRACKET(CENTER)		
14	LP31391-001A	SPECIAL SCREW	BKT(CTR)(x2)	
15	LP31391-001A	SPECIAL SCREW	MAIN PWB(x3)	
16	LP31391-002A	SPECIAL SCREW	MECHA(x3)	
17	QYSPSPD3008ZA	SCREW	DRUM(x3)	
18	LP31391-001A	SPECIAL SCREW	HOUSING	
19	LP21408-001B	SHIELD FRAME(DIGI.)		
20	QYTDST3006ZA	TAP SCREW	JPWB&SFRM(x5)	
21	LP41270-001A	COOLING SHEET		
22	QYSBSGG3006ZA	TAP SCREW	DIGI PWB(x4)	
23	LP31391-001A	SPECIAL SCREW	I-LNK PWB	
24	LP21299-001D	LOADER BKT		
25	QYTDST3006ZA	TAP SCREW	DVD DRIVE(x4)	
26	LP31391-001A	SPECIAL SCREW	LOAD BKT(x4)	
28	LP21407-001C	BRACKET(HDDREG)		
29	LPH40278-008A	HDD	(SERVICE)	
30	LP41257-001A	DAMPER	HDD(x4)	
31	LP41220-001A	SPECIAL SCREW	HDD(x4)	
32	LP31391-001A	SPECIAL SCREW	REG PWB(x4)	
33	QYTDST3006ZA	TAP SCREW	BKT(H/R)(x4)	
△ 34	LP21295-013A	REAR COVER		
△ 35	LP21296-001B	COVER(FAN)		
36	QAR0349-001	COOLING FAN		
37	QYTDSF3010MA	TAP SCREW	FAN(x2)	
38	QYSBSG3006MA	TAP SCREW	COVER(FAN)(x3)	
39	QYSBSG3006NA	TAP SCREW	R.COVER(x2)	
40	QYTDSF3008MA	TAP SCREW	JACK(x7)	
41	QYSBST3004MA	TAP SCREW	TUNER	
42	LP31348-001A	FOOT	(x2)	
△ 43	QMPK340-170-JC	POWER CORD(JP)	1.7m BLACK	E,EF
△ 43	QMPN330-170-K	POWER CORD(JP)	1.7m BLACK	EK
44	QQR0918-001	CORE FILTER	AC CORD	
45	LP30002-0H8A	SPACER	DRUM FFC	
46	LP41171-001A	SHIELD TIGHT	FOR D.SLD(x2)	
47	LP41206-001A	SHEET		
48	LP41171-001A	SHIELD TIGHT	FOR DRIVE	
49	LP30002-0A9A	SPACER	FRNT SHEET	
50	LP31345-001A	EARTH PLATE		
51	LP31345-001A	EARTH PLATE		
52	QQR1634-001	FERRITE CORE	HDD ATAPII(x2)	
△ 53	LP31556-001B	SHEET(HDD)		
54	LP31560-001A	S.PLATE(I LINK)	DV JACK	
△ 55	QAL0704-002	DRIVE UNIT		
56	QGZ0025A1-40	CONNECTOR	ATAPI CN	
58	QGZ0025A1-40	CONNECTOR	(1-40)	
60	PDV2541A	DRUM FINAL ASSY		EF
60	PDV2625A	DRUM FINAL ASSY		E,EK
61	LP21409-001C	S.COVER(DIGI.)		
62	LP41279-001A	SPRING	HDDREG BKT(x2)	
63	LP31391-001A	SPECIAL SCREW	S.PLATE(DV)	
64	QQR1634-001	FERRITE CORE	DRIV ATAPI(x2)	
65	LP30002-0A9A	SPACER	FERRITE(x2)	
66	LP41283-001A	HEAT SINK		
67	QYTDST3006ZA	TAP SCREW	HEAT SINK(x2)	
68	LP41270-001A	COOLING SHEET		
69	LP30002-0A9A	SPACER	DD CONV	
70	LP30002-0A9A	SPACER	BKT(HDD)(x3)	
71	LP30002-0A9A	SPACER	LOADER BKT	
WR 1	QUQ112-1318CG-E	FFC WIRE	JUNCTION CN7107-MAIN CN7111	
WR 2	QUQ212-0434CG-E	FFC WIRE	JUNCTION CN7104-MAIN CN501	

△ Symbol No.	Part No.	Part Name	Description	Local
WR 3	QUQ112-0910CG-E	FFC WIRE	OPERATON JACK CN7201-MAIN CN7112	
WR 4	QUQ112-1510CG-E	FFC WIRE	DISPLAY/SWITCH CN7001-MAIN CN3102	
WR 5	QUQL05-4024AH-E	FFC WIRE	DRIVE UNIT-DIGITAL CN2201	
WR 6	QJJ032-040804-E	SIN CR C-C WIRE	DRIVE UNIT-JUNCTION CN5303	
WR 7	QUQ210-1910CJ-E	FFC WIRE	DIGITAL CN1103-JUNCTION CN7110	
WR 8	QUQL05-4032AH-E	FFC WIRE	HDD-DIGITAL CN2101	
WR 9	QJJ032-042204-E	SIN CR C-C WIRE	HDD-JUNCTION CN5504	
WR10	QUQ212-1512CG-E	FFC WIRE	SWITCHING REGULATOR CN5301-MAIN CN5311	
WR11	QUQ212-1912CG-E	FFC WIRE	SWITCHING REGULATOR CN5304-JUNCTION CN5501	

# VHS mechanism assembly and parts list

Block No. M2MM

PMD0049A-C

Classification	Part No.	Symbol in drawing
Grease	KYODO-SH-JB	AA
Oil	COSMO-HV56	BB

NOTE: The section marked in AA and BB indicate lubrication and greasing areas.

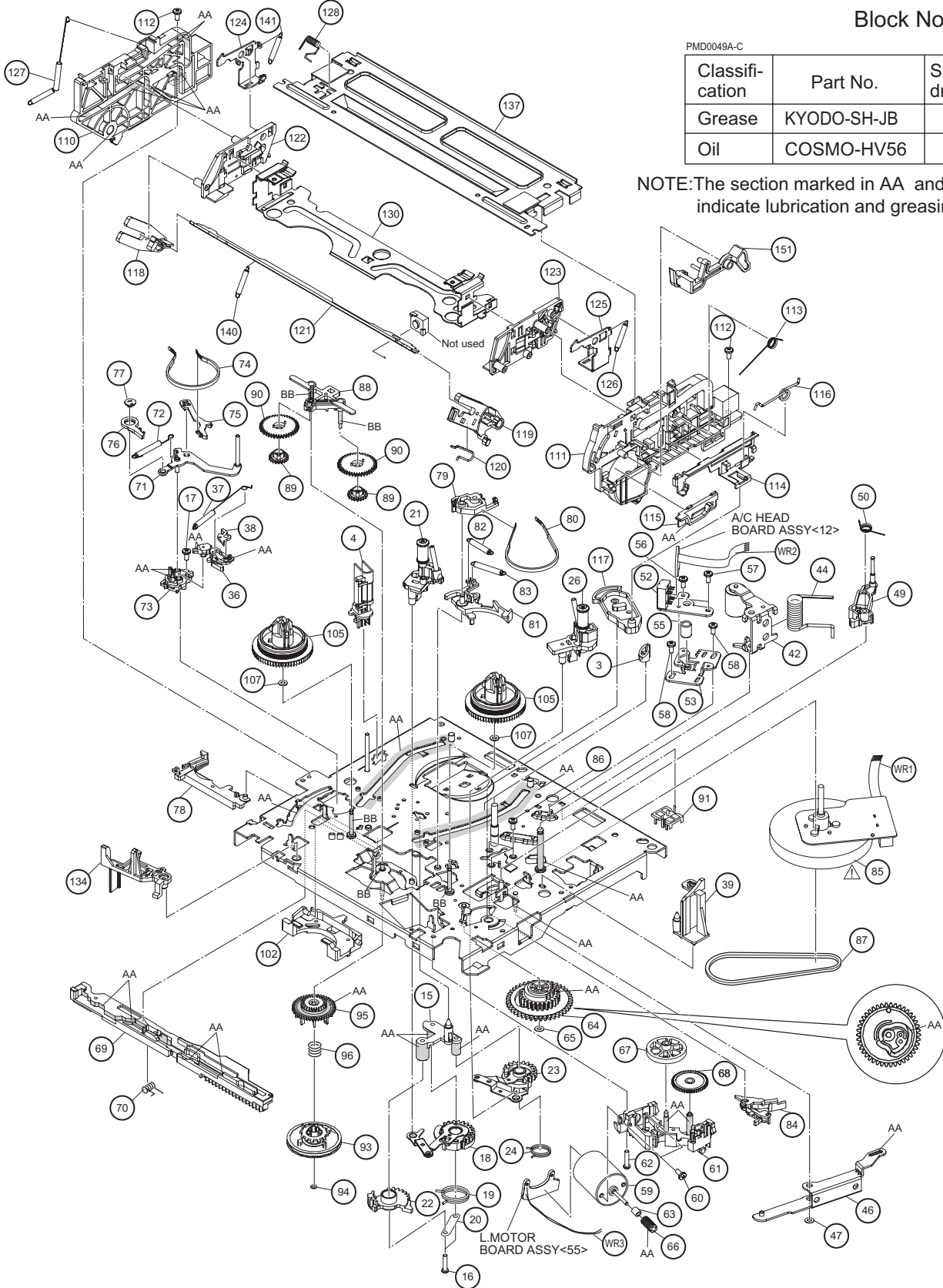

# VHS mechanism

Block No. [M][2][M][M]

△ Symbol No.	Part No.	Part Name	Description	Local
3	LP40097-002E	GUIDE POLE CAP		
4	NAH0004-001	FULL ERASE HEAD		
15	LP30958-001B	LOADING GEAR BASE		
16	QYTPST2620ZA	TAP SCREW	M2.6 x 20mm(x2)	
17	QYTDST2606ZA	TAP SCREW	M2.6 x 6mm	
18	LP40798-002A	LOADING GEAR(SUPPLY) ASSY		
19	LP40837-001A	TORSION SPRING(SUPPLY)		
20	LP40903-004A	FIXING PLATE		
21	LP40806-001D	POLE BASE ASSY(SUPPLY)		
22	LP30959-001B	LOADING GEAR		
23	LP40802-002A	LOADING GEAR(TAKE UP) ASSY		
24	LP40838-001A	TORSION SPRING(TAKE UP)		
26	LP40808-001E	POLE BASE ASSY(TAKE UP)		
36	LP21055-001G	TAKE UP LEVER		
37	LP40943-001A	TENSION SPRING		
38	LP40859-001D	T-UP HEAD		
39	LP30961-001C	LID GUIDE		
42	LP40810-003A	PINCH ROLLER ARM ASSY		
44	LP40840-001E	TORSION SPRING		
46	LP30963-002A	PRESS LEVER		
47	PQM30017-24	SLIT WASHER		
49	LP40813-001D	GUIDE ARM ASSY		
50	LP40841-001A	TORSION SPRING		
52	NAH0005-001	AC HEAD		
53	LP30965-003A	HEAD BASE		
55	LP40842-001D	COMPRESSION SPRING		
56	QYTDST2006MA	TAP SCREW	M2 x 6mm	
57	LP41036-002A	A/C ADJ.SCREW	(x2)	
58	QYTDST2606ZA	TAP SCREW	M2.6 x 6mm(x2)	
59	QAR0289-001	LOADING MOTOR		
60	QYTPSP3003ZA	SCREW	M3 x 3mm(x2)	
61	LP21056-002J	MOTOR BRACKET		
62	QYTPST2620ZA	TAP SCREW	M2.6 x 20mm	
63	LP40814-001B	WORM BEARING		
64	LP21044-001E	CONTROL CAM		
65	PQM30017-24	SLIT WASHER		
66	LP40815-001A	WORM GEAR		
67	LP40816-001B	HELICAL GEAR		
68	LP40817-001A	CONNECT GEAR		
69	LP10400-001N	CONTROL PLATE		
70	LP40843-001A	TORSION SPRING		
71	LP40818-002A	TENSION ARM ASSY		
72	LP40844-001F	TENSION SPRING		
73	LP21045-001E	TENSION ARM BASE		
74	LP40821-001A	TENSION BAND ASSY		
75	LP30967-001B	BAND HOLDER-1		
76	LP30968-001C	BAND HOLDER-2		
77	LP40822-002B	ADJUST PIN		
78	LP31000-005E	TENSION ARM LEVER		
79	LP21046-001C	MAIN BRAKE(TAKE UP)		
80	LP40824-001A	BAND BRAKE ASSY		
81	LP30969-002B	BRAKE LEVER		
82	LP30003-033C	TENSION SPRING		
83	LP30003-035C	TENSION SPRING		
84	LP40825-001B	CAPSTAN BRAKE ASSY		
△ 85	QAR0267-003	CAPSTAN MOTOR		
86	QYTPSG2606ZA	TAP SCREW	M2.6 x 6mm(x3)	
87	LP30005-010A	BELT	CAPSTAN MOTOR	
88	LP30970-001B	IDLER ARM		
89	LP40828-004A	IDLER GEAR 1	(x2)	
90	LP40829-003A	IDLER GEAR 2	(x2)	
91	LP31014-002A	WIRE HOLDER		
93	LP40934-001B	CLUTCH UNIT		
94	PQM30017-47	SLIT WASHER		
95	LP30973-001A	DIRECT GEAR		
96	LP40939-001A	COMPRESSION SPRING		
102	LP30974-001C	CHANGE LEVER		
105	LP21049-001A	REEL DISK	(x2)	
107	LP30017-004A	SPACER	REEL DISK(x2)	
110	LP10401-001L	SIDE FRAME(L)		
111	LP10402-001M	SIDE FRAME(R)		
112	QYTDST2606ZA	TAP SCREW	M2.6 x 6mm(x2)	
113	LP40917-001D	TORSION SPRING		
114	LP30976-002B	SIDE PLATE		
115	LP30977-002E	LIMIT PLATE		
116	LP40846-001C	LIMIT SPRING		
117	LP31100-002A	DRIVE LEVER		
118	LP30978-001B	DRIVE ARM(L)		
119	LP30979-001S	DRIVE ARM(R)		

Symbol No.	Part No.	Part Name	Description	Local
120	LP40847-001B	TORSION SPRING		
121	LP30980-002A	CONNECT PLATE		
122	LP10403-001C	SIDE HOLDER(L)		
123	LP10404-001F	SIDE HOLDER(R)		
124	LP30983-002A	LOCK LEVER(L)		
125	LP30984-002A	LOCK LEVER(R)		
126	LP40924-001D	TENSION SPRING		
127	LP40972-001A	EARTH SPRING(1)		
128	LP40857-001B	EARTH SPRING(2)		
130	LP30981-003B	CASSETTE HOLDER ASSY		
134	LP21051-002C	REC SAFETY LEVER		
137	LP21052-002A	TOP FRAME		
140	LP41153-001A	EARTH SPRING(3)		
141	LP40924-001D	TENSION SPRING		
151	LP30985-002M	DOOR OPENER		
WR1	WJT0117-001A-E	E-CARD WIRE	DRUM	
WR2	WJT0067-001B-E	E-CARD WIRE	A/C HEAD CN2001	
WR3	WJW0023-001A-E	E-TWISTED ASSY		



# Electrical parts list

## Switching regulator board

Block No. [0][1]

Symbol No.	Part No.	Part Name	Description	Local
PW1	LPA10298-03B1	SWITCHING REGULATOR BOARD ASSY		
IC5101	STR-G6653-F9	IC		
IC5301	UTCTL431-T	IC		
IC5301	or TL431/A-T	IC		
IC5302	MM1665AH-X	IC		
Q5303	UN211E-X	DIGI TRANSISTOR		
Q5303	or DTC144WKA-X	DIGI TRANSISTOR		
Q5303	or RT1P44HC-X	DIGI TRANSISTOR		
Q5304	UN2211-X	TRANSISTOR		
Q5304	or DTC114EKA-X	DIGI TRANSISTOR		
Q5304	or RT1N141C-X	DIGI TRANSISTOR		
Q5305	2SC3576-JVC-T	TRANSISTOR		
Q5305	or 2SD2144S/VW-T	TRANSISTOR		
Q5306	2SC6007/F	POW TRANSISTOR		
Q5307	2SA1585S/QR-T	TRANSISTOR		
Q5308	UN2211-X	TRANSISTOR		
Q5308	or DTC114EKA-X	DIGI TRANSISTOR		
Q5308	or RT1N141C-X	DIGI TRANSISTOR		
Q5313	2SA1585S/QR-T	TRANSISTOR		
Q5315	UN2211-X	TRANSISTOR		
Q5315	or DTC114EKA-X	DIGI TRANSISTOR		
Q5315	or RT1N141C-X	DIGI TRANSISTOR		
D5001	GBJ4J	BRIDGE DIODE		
D5001	or D3SBA60	DIODE		
D5001	or KBJ4J	BRIDGE DIODE		
D5101	SARS01-T2	SI DIODE		
D5103	1F4G-T2	FR DIODE		
D5103	or 10ERB20-T2	FR DIODE		
D5103	or 1F4G-G-T2	FR DIODE		
D5104	1SS133-T2	SI DIODE		
D5104	or 1SS270A-T2	SI DIODE		
D5105	1F4G-T2	FR DIODE		
D5105	or 10ERB20-T2	FR DIODE		
D5105	or 1F4G-G-T2	FR DIODE		
D5106	1F4G-T2	FR DIODE		
D5106	or 10ERB20-T2	FR DIODE		
D5106	or 1F4G-G-T2	FR DIODE		
D5202	RS1G-X	FR DIODE		
D5202	or 1SR156-400-X	SI DIODE		
D5203	UF202G-F26	FR DIODE		
D5203	or HER202G-B322-3	FR DIODE		
D5204	SX34-X	SB DIODE		
D5205	RK34-LFB2	SB DIODE		
D5207	SX34-X	SB DIODE		
D5209	SB240-F26	SB DIODE		
D5209	or SB240-B322-3	SB DIODE		
D5210	1F4G-T2	FR DIODE		
D5210	or 10ERB20-T2	FR DIODE		
D5210	or 1F4G-G-T2	FR DIODE		
D5211	1F4G-T2	FR DIODE		
D5211	or 10ERB20-T2	FR DIODE		
D5211	or 1F4G-G-T2	FR DIODE		
D5212	SX34-X	SB DIODE		
D5213	UF202G-F26	FR DIODE		
D5213	or HER202G-B322-3	FR DIODE		
D5303	MTZJ12B-T2	Z DIODE		
D5304	MTZJ5.6C-T2	Z DIODE		
△ PC5101	PC123Y82FZ	PHOTO COUPLER		
△ C5001	QFZ9073-683	MM CAPACITOR	0.068uF AC250V M	
△ C5002	QFZ9073-223	MM CAPACITOR	0.022uF AC250V M	
C5003	QETM2GM-107	E CAPACITOR	100uF 400V M	
△ C5004	QCZ9071-222	C CAPACITOR	2200pF AC400V M	
△ C5005	QCZ9071-101	C CAPACITOR	100pF AC400V K	
C5102	QCZ0212-472	C CAPACITOR	4700pF 1kV K	
C5103	QEZ0657-276Z	E CAPACITOR	27uF 35V M	
C5104	QCZ0136-471Z	C CAPACITOR	470pF 1kV K	
C5105	NDC31HJ-471X	C CAPACITOR	470pF 50V J	

Symbol No.	Part No.	Part Name	Description	Local
C5106	NCB31HK-103X	C CAPACITOR	0.01uF 50V K	
C5107	NDC31HJ-331X	C CAPACITOR	330pF 50V J	
C5202	QETN2AM-475Z	E CAPACITOR	4.7uF 100V M	
C5203	QEZ0701-827	E CAPACITOR	820uF 16V M	
C5204	QEZ0701-827	E CAPACITOR	820uF 16V M	
C5205	QEZ0700-228	E CAPACITOR	2200uF 10V M	
C5206	QTM91AM-338	E CAPACITOR	3300uF 10V M	
C5208	QEZ0700-128	E CAPACITOR	1200uF 10V M	
C5209	QEZ0658-186Z	E CAPACITOR	18uF 50V M	
C5210	QEZ0653-227Z	E CAPACITOR	220uF 6.3V M	
C5301	QFVF1HJ-154Z	MF CAPACITOR	0.15uF 50V J	
C5302	QFLC1HJ-333Z	M CAPACITOR	0.033uF 50V J	
C5303	QETN1CM-107Z	E CAPACITOR	100uF 16V M	
C5304	QETN1CM-107Z	E CAPACITOR	100uF 16V M	
C5305	QETN1AM-227Z	E CAPACITOR	220uF 10V M	
C5306	QETN1AM-227Z	E CAPACITOR	220uF 10V M	
C5311	QETN1CM-107Z	E CAPACITOR	100uF 16V M	
C5312	QETN1AM-227Z	E CAPACITOR	220uF 10V M	
C5321	NCF31AZ-105X	C CAPACITOR	1uF 10V Z	
C5322	NCB30JK-105X	C CAPACITOR	1uF 6.3V K	
C5323	NCB31HK-103X	C CAPACITOR	0.01uF 50V K	
C5324	QEZ0654-477Z	E CAPACITOR	470uF 10V M	
C5325	QETN1CM-477Z	E CAPACITOR	470uF 16V M	
C5330	NCF31CZ-104X	C CAPACITOR	0.1uF 16V Z	
C5331	NCF31CZ-104X	C CAPACITOR	0.1uF 16V Z	
C5335	NCF31CZ-104X	C CAPACITOR	0.1uF 16V Z	
R5101	QRG02GJ-683	OMF RESISTOR	68kΩ 2W J	
R5102	NRSA63J-122X	MG RESISTOR	1.2kΩ 1/16W J	
R5103	QRE141J-684Y	C RESISTOR	680kΩ 1/4W J	
R5104	NRSA63J-102X	MG RESISTOR	1kΩ 1/16W J	
R5105	QRE141J-270Y	C RESISTOR	27Ω 1/4W J	
R5106	QRE141J-392Y	C RESISTOR	3.9kΩ 1/4W J	
R5107	NRSA63J-681X	MG RESISTOR	680Ω 1/16W J	
R5108	QRT01DJ-R27X	MF RESISTOR	0.27Ω 1W J	
△ R5109	QRZ9051-470X	FUSI RESISTOR	47Ω 1/4W J	
R5301	NRSA63J-221X	MG RESISTOR	220Ω 1/16W J	
R5302	NRSA63J-472X	MG RESISTOR	4.7kΩ 1/16W J	
R5303	NRSA63J-152X	MG RESISTOR	1.5kΩ 1/16W J	
R5304	NRSA63F-682X	MG RESISTOR	6.8kΩ 1/16W F	
R5305	NRSA63J-203X	MG RESISTOR	20kΩ 1/16W J	
R5306	NRSA63F-392X	MG RESISTOR	3.9kΩ 1/16W F	
R5308	NRSA63J-122X	MG RESISTOR	1.2kΩ 1/16W J	
R5309	NRSA63J-102X	MG RESISTOR	1kΩ 1/16W J	
R5313	QRE141J-103Y	C RESISTOR	10kΩ 1/4W J	
R5314	QRE141J-391Y	C RESISTOR	390Ω 1/4W J	
R5315	QRE121J-121Y	C RESISTOR	120Ω 1/2W J	
R5316	NRSA63J-103X	MG RESISTOR	10kΩ 1/16W J	
R5317	NRSA63J-102X	MG RESISTOR	1kΩ 1/16W J	
R5327	NRSA63J-103X	MG RESISTOR	10kΩ 1/16W J	
R5328	QRE141J-821Y	C RESISTOR	820Ω 1/4W J	
R5329	QRE141J-821Y	C RESISTOR	820Ω 1/4W J	
L5201	QQR1633-001	CORE FILTER		
L5202	QQR1633-001	CORE FILTER		
L5204	QQR1633-001	CORE FILTER		
L5205	QQR1633-001	CORE FILTER		
L5207	QQR1633-001	CORE FILTER		
△ T5001	QQS0336-001	SW TRANSF		
B5303	NRSA63J-0R0X	MG RESISTOR	0Ω 1/16W J	
B5304	NRSA63J-0R0X	MG RESISTOR	0Ω 1/16W J	
B5310	NRSA63J-0R0X	MG RESISTOR	0Ω 1/16W J	
△ CN5001	QGA7901C3-02	CONNECTOR	W-B (1-2)	
CN5301	QGF1208C1-15	CONNECTOR	FFC/FPC (1-15)	
CN5302	QGA2001C1-02	CONNECTOR	W-B (1-2)	
CN5303	QGA2501C1-04	CONNECTOR	W-B (1-4)	
CN5304	QGF1208C1-19	CONNECTOR	FFC/FPC (1-19)	
CN7110	QGF1040C1-19	CONNECTOR	FFC/FPC (1-19)	E,EK
△ CP5301	QMFZ053-1R5Z-J1	FUSE	1.5A	
△ F5001	QMF51W2-2R0-J8	FUSE	2A AC250V	
FC5001	QNG0020-001Z	FUSE CLIP		
FC5002	QNG0020-001Z	FUSE CLIP		
△ LF5002	QQR1031-001	LINE FILTER		
W52	NRSA63J-0R0X	MG RESISTOR	0Ω 1/16W J	
HS1	QZW0162-001	HEAT SINK	FOR IC5101	
OT1	QYTDST3008ZA	TAP SCREW	M3 x 8mm FOR IC5101	

# Main board

## Block No. [0][3]

△ Symbol No.	Part No.	Part Name	Description	Local
PW1	LPA10293-13C	MAIN BOARD ASSY		E
PW1	LPA10293-15C	MAIN BOARD ASSY		EF
PW1	LPA10293-14C	MAIN BOARD ASSY		EK
IC1	JCP8060-MSA	IC		
IC201	LC74788N-9751-E	IC		
IC501	BH7623KS2	IC		
△ IC2201	AN3651FBP	IC		
IC2601	RC4558D-X	IC		
IC2601	or BA15218F-XE	IC		
IC2602	CD4052BM-X	IC		
IC2603	RC4558D-X	IC		
IC2603	or BA15218F-XE	IC		
IC2604	CD4052BM-X	IC		
IC2605	RC4558D-X	IC		
IC2606	LA7151-E	IC		
IC2607	LA7151-E	IC		
IC3001	HD6432194SAE18F	IC(MCU)	MASK	EF
IC3001	HD6432194SAE17F	IC(MCU)	MASK	E,EK
IC3002	S-80827CNNB-G-W	IC		
IC3002	or IC-PST3427U-X	IC		
IC3003	LPN1009-001D-31	IC(EEPROM)	*(REFER TO BELOW)	E
IC3003	LPN1009-003C-33	IC(EEPROM)	*(REFER TO BELOW)	EF
IC3003	LPN1009-002D-32	IC(EEPROM)	*(REFER TO BELOW)	EK
IC3601	BU2090FS-X	IC		
IC4201	LC74793-E	IC		
IC4202	MM1504XN-X	IC		
IC4301	LA7357M-E-W	IC		EF
IC4304	74HC4538D-X	IC		EF
IC7101	CD74HC4053PW-X	IC		
IC7501	SN74LV08APW-X	IC		
Q7	2SC2412K/QRS/-X	TRANSISTOR		
Q7	or 2SD601A/QRS/-X	TRANSISTOR		
Q7	or 2SC3928A/QRS/-X	TRANSISTOR		
Q8	2SC2412K/QRS/-X	TRANSISTOR		
Q8	or 2SD601A/QRS/-X	TRANSISTOR		
Q8	or 2SC3928A/QRS/-X	TRANSISTOR		
Q9	2SC2412K/QRS/-X	TRANSISTOR		
Q9	or 2SD601A/QRS/-X	TRANSISTOR		
Q9	or 2SC3928A/QRS/-X	TRANSISTOR		
Q10	2SC2412K/QRS/-X	TRANSISTOR		
Q10	or 2SD601A/QRS/-X	TRANSISTOR		
Q10	or 2SC3928A/QRS/-X	TRANSISTOR		
Q16	2SA1037AK/QR/-X	TRANSISTOR		
Q16	or 2SB709A/QR/-X	TRANSISTOR		
Q16	or 2SA1530A/QR/-X	TRANSISTOR		
Q202	2SC2412K/QRS/-X	TRANSISTOR		
Q202	or 2SD601A/QRS/-X	TRANSISTOR		
Q202	or 2SC3928A/QRS/-X	TRANSISTOR		
Q203	2SA1037AK/QR/-X	TRANSISTOR		
Q203	or 2SB709A/QR/-X	TRANSISTOR		
Q203	or 2SA1530A/QR/-X	TRANSISTOR		
Q501	2SA1037AK/QR/-X	TRANSISTOR		
Q502	2SC2412K/QRS/-X	TRANSISTOR		
Q503	2SA1037AK/QR/-X	TRANSISTOR		
Q504	DTC144WKA-X	DIGI TRANSISTOR		
Q504	or UN221E-X	TRANSISTOR		
Q504	or RT1N44HC-X	DIGI TRANSISTOR		
Q2001	2SC2412K/QRS/-X	TRANSISTOR		
Q2001	or 2SD601A/QRS/-X	TRANSISTOR		
Q2001	or 2SC3928A/QRS/-X	TRANSISTOR		
Q2002	2SC2412K/QRS/-X	TRANSISTOR		
Q2002	or 2SD601A/QRS/-X	TRANSISTOR		
Q2002	or 2SC3928A/QRS/-X	TRANSISTOR		
Q2003	DTA144WKA-X	TRANSISTOR		
Q2003	or UN211E-X	DIGI TRANSISTOR		
Q2003	or RT1P44HC-X	DIGI TRANSISTOR		
Q2051	2SC2412K/QRS/-X	TRANSISTOR		
Q2051	or 2SD601A/QRS/-X	TRANSISTOR		
Q2051	or 2SC3928A/QRS/-X	TRANSISTOR		
Q2052	2SA1037AK/QR/-X	TRANSISTOR		
Q2052	or 2SB709A/QR/-X	TRANSISTOR		
Q2052	or 2SA1530A/QR/-X	TRANSISTOR		
Q2053	DTC144WKA-X	DIGI TRANSISTOR		

△ Symbol No.	Part No.	Part Name	Description	Local
Q2053	or UN221E-X	TRANSISTOR		
Q2053	or RT1N44HC-X	DIGI TRANSISTOR		
Q2054	2SA1037AK/QR/-X	TRANSISTOR		
Q2054	or 2SB709A/QR/-X	TRANSISTOR		
Q2054	or 2SA1530A/QR/-X	TRANSISTOR		
Q2055	DTC144WKA-X	DIGI TRANSISTOR		
Q2055	or UN221E-X	TRANSISTOR		
Q2055	or RT1N44HC-X	DIGI TRANSISTOR		
Q2201	DTA144WKA-X	TRANSISTOR		
Q2201	or UN211E-X	DIGI TRANSISTOR		
Q2201	or RT1P44HC-X	DIGI TRANSISTOR		
Q2202	DTC144WKA-X	DIGI TRANSISTOR		
Q2202	or UN221E-X	TRANSISTOR		
Q2202	or RT1N44HC-X	DIGI TRANSISTOR		
Q2203	2SC2412K/QRS/-X	TRANSISTOR		
Q2203	or 2SD601A/QRS/-X	TRANSISTOR		
Q2203	or 2SC3928A/QRS/-X	TRANSISTOR		
Q2204	2SC2412K/QRS/-X	TRANSISTOR		
Q2204	or 2SD601A/QRS/-X	TRANSISTOR		
Q2204	or 2SC3928A/QRS/-X	TRANSISTOR		
Q2255	DTC114EKA-X	DIGI TRANSISTOR		
Q2255	or UN2211-X	TRANSISTOR		
Q2255	or RT1N141C-X	DIGI TRANSISTOR		
Q2601	2SC2412K/QRS/-X	TRANSISTOR		
Q2601	or 2SD601A/QRS/-X	TRANSISTOR		
Q2601	or 2SC3928A/QRS/-X	TRANSISTOR		
Q2602	2SC2412K/QRS/-X	TRANSISTOR		
Q2602	or 2SD601A/QRS/-X	TRANSISTOR		
Q2602	or 2SC3928A/QRS/-X	TRANSISTOR		
Q2603	DTA144WKA-X	TRANSISTOR		
Q2603	or UN211E-X	DIGI TRANSISTOR		
Q2603	or RT1P44HC-X	DIGI TRANSISTOR		
Q2604	2SC2412K/QRS/-X	TRANSISTOR		
Q2604	or 2SD601A/QRS/-X	TRANSISTOR		
Q2604	or 2SC3928A/QRS/-X	TRANSISTOR		
Q2605	2SC2412K/QRS/-X	TRANSISTOR		
Q2605	or 2SD601A/QRS/-X	TRANSISTOR		
Q2605	or 2SC3928A/QRS/-X	TRANSISTOR		
Q2606	DTA144WKA-X	TRANSISTOR		
Q2606	or UN211E-X	DIGI TRANSISTOR		
Q2606	or RT1P44HC-X	DIGI TRANSISTOR		
Q3002	PTZ-NV16A	IC(PHOTO SENSOR)		
Q3003	PTZ-NV16A	IC(PHOTO SENSOR)		
Q3004	2SD601A/QRS/-X	TRANSISTOR		
Q3004	or 2SC2412K/QRS/-X	TRANSISTOR		
Q3004	or 2SC3928A/QRS/-X	TRANSISTOR		
Q3005	2SD601A/QRS/-X	TRANSISTOR		
Q3005	or 2SC2412K/QRS/-X	TRANSISTOR		
Q3005	or 2SC3928A/QRS/-X	TRANSISTOR		
Q3007	UN221E-X	TRANSISTOR		
Q3007	or DTC144WKA-X	DIGI TRANSISTOR		
Q3007	or RT1N44HC-X	DIGI TRANSISTOR		
Q3011	UN221L-X	DIGI TRANSISTOR		
Q3011	or DTC143EKA-X	DIGI TRANSISTOR		
Q3011	or RT1N431C-X	DIGI TRANSISTOR		
Q3901	UN221E-X	TRANSISTOR		
Q3901	or DTC144WKA-X	DIGI TRANSISTOR		
Q3901	or RT1N44HC-X	DIGI TRANSISTOR		
Q4001	UN2211-X	TRANSISTOR		
Q4001	or DTC114EKA-X	DIGI TRANSISTOR		
Q4001	or RT1N141C-X	DIGI TRANSISTOR		
Q4201	2SC2412K/QRS/-X	TRANSISTOR		
Q4201	or 2SD601A/QRS/-X	TRANSISTOR		
Q4201	or 2SC3928A/QRS/-X	TRANSISTOR		
Q4302	2SA1037AK/QR/-X	TRANSISTOR		
Q4303	2SA1037AK/QR/-X	TRANSISTOR		
Q6001	2SD2144S/UV/-T	TRANSISTOR		
Q6030	2SA1037AK/QR/-X	TRANSISTOR		
Q6030	or 2SA1530A/QR/-X	TRANSISTOR		
Q7301	2SC2412K/QRS/-X	TRANSISTOR		
Q7302	2SA720/RS/-T	TRANSISTOR		
D202	1SS133-T2	SI DIODE		
D203	1SS133-T2	SI DIODE		
D2001	1SS133-T2	SI DIODE		
D2001	or 1SS270A-T2	SI DIODE		
D2251	1SS133-T2	SI DIODE		
D2251	or 1SS270A-T2	SI DIODE		

EF  
EF

3-10(No.YD084) After exchanging EEPROMs, a main part does not correspond to some remote control commands at Jig RCU mode. Please cancel the Jig RCU mode of a main part after exchanging EEPROMs. Please refer to the "Canceling JIG mode" about the release method.

△ Symbol No.	Part No.	Part Name	Description	Local	△ Symbol No.	Part No.	Part Name	Description	Local
D2601	1SS133-T2	SI DIODE			C63	NCB31EK-103X	C CAPACITOR	0.01uF 25V K	
D2601	or 1SS270A-T2	SI DIODE			C64	NCB31EK-103X	C CAPACITOR	0.01uF 25V K	
D2602	1SS133-T2	SI DIODE			C71	QEKJ1HM-105Z	E CAPACITOR	1uF 50V M	
D2602	or 1SS270A-T2	SI DIODE			C75	NDC31HJ-390X	C CAPACITOR	39pF 50V J	EF
D3001	LNB2301L01VI	LED			C85	QCB11HK-103Y	C CAPACITOR	0.01uF 50V K	
D3002	1SS133-T2	SI DIODE			C201	QETN0JM-477Z	E CAPACITOR	470uF 6.3V M	
D3002	or 1SS270A-T2	SI DIODE			C203	NCB31AK-474X	C CAPACITOR	0.47uF 10V K	
D3003	MTZJ39C-T2	Z DIODE			C204	QEKJ1HM-105Z	E CAPACITOR	1uF 50V M	
D3004	10EDB20-T2	SI DIODE			C205	QEKJ1HM-105Z	E CAPACITOR	1uF 50V M	
D3004	or 1A3G-T2	SI DIODE			C206	NDC31HJ-560X	C CAPACITOR	56pF 50V J	
D3005	10EDB20-T2	SI DIODE			C207	NCB31EK-103X	C CAPACITOR	0.01uF 25V K	
D3005	or 1A3G-T2	SI DIODE			C208	NDC31HJ-330X	C CAPACITOR	33pF 50V J	
D3008	1SS133-T2	SI DIODE			C209	NDC31HJ-330X	C CAPACITOR	33pF 50V J	
D3008	or 1SS270A-T2	SI DIODE			C213	NCB31AK-224X	C CAPACITOR	0.22uF 10V K	
D3011	1SS133-T2	SI DIODE			C501	NCF31AZ-105X	C CAPACITOR	1uF 10V Z	
D4001	NRSA63J-0R0X	MG RESISTOR	0Ω 1/16W J		C503	NCF31AZ-105X	C CAPACITOR	1uF 10V Z	
D4002	1SS355-X	SI DIODE			C505	NCF31AZ-105X	C CAPACITOR	1uF 10V Z	
D4002	or MA111-X	SI DIODE			C507	NCF31AZ-105X	C CAPACITOR	1uF 10V Z	
D4301	1SS133-T2	SI DIODE		EF	C509	NCB31CK-104X	C CAPACITOR	0.1uF 16V K	
D6002	HZ30-2L-T2	Z DIODE			C511	QCB11HK-103Y	C CAPACITOR	0.01uF 50V K	
D7301	DA204U-X	SI DIODE			C513	QEKJ0JM-476Z	E CAPACITOR	47uF 6.3V M	
D7302	DA204U-X	SI DIODE			C514	QCB11HK-103Y	C CAPACITOR	0.01uF 50V K	
PC3001	RPI-304J	IC(PHOTO SENSOR			C516	NCB31CK-104X	C CAPACITOR	0.1uF 16V K	
PC3002	RPI-304J	IC(PHOTO SENSOR			C517	NCB31EK-103X	C CAPACITOR	0.01uF 25V K	
C1	NDC31HJ-151X	C CAPACITOR	150pF 50V J		C519	NCB31EK-103X	C CAPACITOR	0.01uF 25V K	
C2	NDC31HJ-390X	C CAPACITOR	39pF 50V J	EF	C521	QEKJ1CM-106Z	E CAPACITOR	10uF 16V M	
C2	NDC31HJ-470X	C CAPACITOR	47pF 50V J	E,EK	C523	NCF31AZ-105X	C CAPACITOR	1uF 10V Z	
C3	NDC31HJ-7R0X	C CAPACITOR	7pF 50V J	EF	C524	NCB31CK-104X	C CAPACITOR	0.1uF 16V K	
C4	QEKJ1EM-106Z	E CAPACITOR	10uF 25V M		C525	NCF31AZ-105X	C CAPACITOR	1uF 10V Z	
C5	NCB31CK-104X	C CAPACITOR	0.1uF 16V K		C526	NCF31AZ-105X	C CAPACITOR	1uF 10V Z	
C6	NCB31CK-104X	C CAPACITOR	0.1uF 16V K		C528	NCF31AZ-105X	C CAPACITOR	1uF 10V Z	
C7	NCB31CK-104X	C CAPACITOR	0.1uF 16V K		C530	NCF31AZ-105X	C CAPACITOR	1uF 10V Z	
C8	NCF31AZ-105X	C CAPACITOR	1uF 10V Z		C532	NCB31CK-104X	C CAPACITOR	0.1uF 16V K	
C9	QEKJ1HM-225Z	E CAPACITOR	2.2uF 50V M		C534	NCB31CK-104X	C CAPACITOR	0.1uF 16V K	
C10	QEKJ0JM-476Z	E CAPACITOR	47uF 6.3V M		C535	NDC31HJ-101X	C CAPACITOR	100pF 50V J	
C11	NCF31AZ-105X	C CAPACITOR	1uF 10V Z		C536	NCB31CK-333X	C CAPACITOR	0.033uF 16V K	
C12	NCF31AZ-105X	C CAPACITOR	1uF 10V Z		C542	NCB31CK-104X	C CAPACITOR	0.1uF 16V K	
C13	NCF31AZ-105X	C CAPACITOR	1uF 10V Z		C543	NCB31EK-103X	C CAPACITOR	0.01uF 25V K	
C14	NCF31AZ-105X	C CAPACITOR	1uF 10V Z		C544	QEKJ0JM-476Z	E CAPACITOR	47uF 6.3V M	
C15	NCB31CK-104X	C CAPACITOR	0.1uF 16V K		C547	NCB31EK-103X	C CAPACITOR	0.01uF 25V K	
C17	NCB31CK-104X	C CAPACITOR	0.1uF 16V K		C552	NCB31EK-103X	C CAPACITOR	0.01uF 25V K	
C19	NCB31CK-104X	C CAPACITOR	0.1uF 16V K		C2001	QEKJ1HM-475Z	E CAPACITOR	4.7uF 50V M	
C20	NCB31CK-104X	C CAPACITOR	0.1uF 16V K		C2002	QEKJ1HM-105Z	E CAPACITOR	1uF 50V M	
C22	NCB31CK-104X	C CAPACITOR	0.1uF 16V K		C2003	QEKJ0JM-476Z	E CAPACITOR	47uF 6.3V M	
C24	NCB31CK-104X	C CAPACITOR	0.1uF 16V K		C2005	QEKJ1HM-475Z	E CAPACITOR	4.7uF 50V M	
C25	QEKJ1HM-335Z	E CAPACITOR	3.3uF 50V M		C2006	NCB31EK-682X	C CAPACITOR	6800pF 25V K	
C26	QEKJ1EM-106Z	E CAPACITOR	10uF 25V M		C2007	QEKJ1CM-226Z	E CAPACITOR	22uF 16V M	
C27	NCB31EK-103X	C CAPACITOR	0.01uF 25V K		C2008	QEKJ1HM-475Z	E CAPACITOR	4.7uF 50V M	
C29	NCB31EK-103X	C CAPACITOR	0.01uF 25V K	EF	C2009	NCB31HK-102X	C CAPACITOR	1000pF 50V K	
C30	QCB11HK-331Y	C CAPACITOR	330pF 50V K		C2010	NCB31HK-681X	C CAPACITOR	680pF 50V K	
C31	QEKJ0JM-476Z	E CAPACITOR	47uF 6.3V M		C2011	QEKJ1HM-475Z	E CAPACITOR	4.7uF 50V M	
C32	NCB31EK-103X	C CAPACITOR	0.01uF 25V K		C2012	QEKJ1HM-475Z	E CAPACITOR	4.7uF 50V M	
C33	QEKJ1EM-106Z	E CAPACITOR	10uF 25V M		C2013	NDC31HJ-331X	C CAPACITOR	330pF 50V J	
C34	NCB31EK-103X	C CAPACITOR	0.01uF 25V K		C2051	NDC31HJ-331X	C CAPACITOR	330pF 50V J	
C35	QCB11HK-103Y	C CAPACITOR	0.01uF 50V K		C2052	QFV61HJ-823Z	MF CAPACITOR	0.082uF 50V J	
C36	QEKJ1HM-105Z	E CAPACITOR	1uF 50V M		C2053	NCB31HK-472X	C CAPACITOR	4700pF 50V K	
C37	NDC31HJ-4R0X	C CAPACITOR	4pF 50V J		C2054	NCB31EK-223X	C CAPACITOR	0.022uF 25V K	
C38	NCB31EK-103X	C CAPACITOR	0.01uF 25V K		C2055	QEKJ1EM-106Z	E CAPACITOR	10uF 25V M	
C39	QEKJ0JM-476Z	E CAPACITOR	47uF 6.3V M		C2201	QEKJ1EM-106Z	E CAPACITOR	10uF 25V M	
C40	NCB31EK-103X	C CAPACITOR	0.01uF 25V K		C2202	QEKJ1HM-475Z	E CAPACITOR	4.7uF 50V M	
C41	NCB31CK-104X	C CAPACITOR	0.1uF 16V K		C2203	QEKJ1HM-475Z	E CAPACITOR	4.7uF 50V M	
C43	QEKJ1HM-335Z	E CAPACITOR	3.3uF 50V M		C2204	QEKJ0JM-336Z	E CAPACITOR	33uF 6.3V M	
C44	QEKJ1HM-225Z	E CAPACITOR	2.2uF 50V M		C2205	QEKJ1EM-106Z	E CAPACITOR	10uF 25V M	
C45	NCB31EK-472X	C CAPACITOR	4700pF 25V K		C2206	QEKJ1EM-106Z	E CAPACITOR	10uF 25V M	
C46	NCB31CK-104X	C CAPACITOR	0.1uF 16V K		C2207	NCB31EK-153X	C CAPACITOR	0.015uF 25V K	
C47	QEKJ1HM-474Z	E CAPACITOR	0.47uF 50V M		C2208	NCB31EK-153X	C CAPACITOR	0.015uF 25V K	
C48	NCB31EK-223X	C CAPACITOR	0.022uF 25V K		C2209	QEKJ1EM-106Z	E CAPACITOR	10uF 25V M	
C49	QEKJ1HM-475Z	E CAPACITOR	4.7uF 50V M		C2210	QEKJ1EM-106Z	E CAPACITOR	10uF 25V M	
C50	NCB31EK-103X	C CAPACITOR	0.01uF 25V K	EF	C2211	QEKJ0JM-336Z	E CAPACITOR	33uF 6.3V M	
C56	NCB31CK-104X	C CAPACITOR	0.1uF 16V K		C2212	QEKJ0JM-476Z	E CAPACITOR	47uF 6.3V M	
C57	NCB31EK-103X	C CAPACITOR	0.01uF 25V K		C2214	QEKJ1EM-106Z	E CAPACITOR	10uF 25V M	
C58	NCB31EK-103X	C CAPACITOR	0.01uF 25V K		C2215	QEKJ1EM-106Z	E CAPACITOR	10uF 25V M	
C59	NCB31EK-103X	C CAPACITOR	0.01uF 25V K		C2216	QEKJ1CM-476Z	E CAPACITOR	47uF 16V M	
C60	NCB31EK-103X	C CAPACITOR	0.01uF 25V K		C2220	QEKJ1EM-106Z	E CAPACITOR	10uF 25V M	
C61	QEKJ0JM-476Z	E CAPACITOR	47uF 6.3V M		C2221	NCB31EK-223X	C CAPACITOR	0.022uF 25V K	
C62	QCB11HK-103Y	C CAPACITOR	0.01uF 50V K		C2222	NCB31EK-103X	C CAPACITOR	0.01uF 25V K	
					C2223	NCB31CK-473X	C CAPACITOR	0.047uF 16V K	
					C2224	NCB31CK-473X	C CAPACITOR	0.047uF 16V K	

△ Symbol No.	Part No.	Part Name	Description	Local	△ Symbol No.	Part No.	Part Name	Description	Local
C2227	QEKJ1EM-106Z	E CAPACITOR	10uF 25V M		C4217	NCB30JK-105X	C CAPACITOR	1uF 6.3V K	
C2251	NCB31EK-103X	C CAPACITOR	0.01uF 25V K		C4218	NCB30JK-105X	C CAPACITOR	1uF 6.3V K	
C2252	NCB31EK-103X	C CAPACITOR	0.01uF 25V K		C4301	NCB31EK-103X	C CAPACITOR	0.01uF 25V K	EF
C2253	NCB31EK-103X	C CAPACITOR	0.01uF 25V K		C4302	QEKJ0JM-476Z	E CAPACITOR	47uF 6.3V M	EF
C2254	QEKJ0JM-476Z	E CAPACITOR	47uF 6.3V M		C4304	NCB31EK-103X	C CAPACITOR	0.01uF 25V K	EF
C2255	NCB31EK-103X	C CAPACITOR	0.01uF 25V K		C4305	NCB31EK-103X	C CAPACITOR	0.01uF 25V K	EF
C2256	NCB31EK-103X	C CAPACITOR	0.01uF 25V K		C4306	NCB31EK-103X	C CAPACITOR	0.01uF 25V K	EF
C2257	QCBB1HK-103Y	C CAPACITOR	0.01uF 50V K		C4307	NCB31EK-103X	C CAPACITOR	0.01uF 25V K	EF
C2258	NDC31HJ-181X	C CAPACITOR	180pF 50V J		C4308	NCB31EK-103X	C CAPACITOR	0.01uF 25V K	EF
C2259	QEKJ1HM-334Z	E CAPACITOR	0.33uF 50V M		C4309	NCB31EK-103X	C CAPACITOR	0.01uF 25V K	EF
C2261	NDC31HJ-101X	C CAPACITOR	100pF 50V J		C4310	NDC31HJ-471X	C CAPACITOR	470pF 50V J	EF
C2262	NDC31HJ-101X	C CAPACITOR	100pF 50V J		C4318	NCB31CK-104X	C CAPACITOR	0.1uF 16V K	EF
C2601	NCB31HK-103X	C CAPACITOR	0.01uF 50V K		C4319	NDC31HJ-471X	C CAPACITOR	470pF 50V J	EF
C2602	NCB31HK-103X	C CAPACITOR	0.01uF 50V K		C6001	QEKJ0JM-107Z	E CAPACITOR	100uF 6.3V M	
C2603	QEKJ1EM-106Z	E CAPACITOR	10uF 25V M		C6002	NCB31HK-103X	C CAPACITOR	0.01uF 50V K	
C2604	QEKJ1EM-106Z	E CAPACITOR	10uF 25V M		C6013	NCB31HK-103X	C CAPACITOR	0.01uF 50V K	
C2605	QEKJ1HM-105Z	E CAPACITOR	1uF 50V M		C6014	NDC31HJ-101X	C CAPACITOR	100pF 50V J	
C2606	QEKJ1HM-105Z	E CAPACITOR	1uF 50V M		C6037	QEKJ1HM-225Z	E CAPACITOR	2.2uF 50V M	
C2607	QEKJ1HM-475Z	E CAPACITOR	4.7uF 50V M		C6752	NCB31HK-103X	C CAPACITOR	0.01uF 50V K	
C2608	QEKJ1HM-475Z	E CAPACITOR	4.7uF 50V M		C7301	NDC31HJ-101X	C CAPACITOR	100pF 50V J	
C2609	QEKJ1HM-105Z	E CAPACITOR	1uF 50V M		C7302	NCB31CK-104X	C CAPACITOR	0.1uF 16V K	
C2610	QEKJ1HM-105Z	E CAPACITOR	1uF 50V M		C7303	NDC31HJ-101X	C CAPACITOR	100pF 50V J	
C2611	QEKJ1EM-106Z	E CAPACITOR	10uF 25V M		C7304	NDC31HJ-101X	C CAPACITOR	100pF 50V J	
C2612	QEKJ1HM-105Z	E CAPACITOR	1uF 50V M		C7305	NDC31HJ-101X	C CAPACITOR	100pF 50V J	
C2613	QEKJ1HM-105Z	E CAPACITOR	1uF 50V M		C7306	NDC31HJ-101X	C CAPACITOR	100pF 50V J	
C2614	QEKJ1HM-475Z	E CAPACITOR	4.7uF 50V M		C7307	QETJ0JM-337Z	E CAPACITOR	330uF 6.3V M	
C2615	QEKJ1HM-475Z	E CAPACITOR	4.7uF 50V M		C7501	QEKJ0JM-107Z	E CAPACITOR	100uF 6.3V M	
C2616	QEKJ1HM-105Z	E CAPACITOR	1uF 50V M		C7502	NCB31CK-104X	C CAPACITOR	0.1uF 16V K	
C2617	QEKJ1HM-105Z	E CAPACITOR	1uF 50V M		C7503	QEKJ1HM-475Z	E CAPACITOR	4.7uF 50V M	
C2618	QEKJ1EM-106Z	E CAPACITOR	10uF 25V M		C7504	NDC31HJ-151X	C CAPACITOR	150pF 50V J	
C2651	QEKJ1CM-476Z	E CAPACITOR	47uF 16V M		C7505	NDC31HJ-151X	C CAPACITOR	150pF 50V J	
C2653	QEKJ1CM-476Z	E CAPACITOR	47uF 16V M		C7509	NCB31CK-104X	C CAPACITOR	0.1uF 16V K	
C3004	NCB31EK-473X	C CAPACITOR	0.047uF 25V K		R1	NRSA63J-622X	MG RESISTOR	6.2kΩ 1/16W J	
C3010	QEZ0244-229	EDL CAPACITOR	0.022F 5.5V Z		R2	NRSA63J-152X	MG RESISTOR	1.5kΩ 1/16W J	
C3012	QEKJ0JM-476Z	E CAPACITOR	47uF 6.3V M		R3	NRSA63J-822X	MG RESISTOR	8.2kΩ 1/16W J	EF
C3015	NCB31CK-104X	C CAPACITOR	0.1uF 16V K		R3	NRSA63J-472X	MG RESISTOR	4.7kΩ 1/16W J	E,EK
C3016	NCB31CK-104X	C CAPACITOR	0.1uF 16V K		R5	NRSA63J-821X	MG RESISTOR	820Ω 1/16W J	EF
C3022	NCB31CK-104X	C CAPACITOR	0.1uF 16V K		R11	NRSA63J-273X	MG RESISTOR	27kΩ 1/16W J	
C3024	NDC31HJ-220X	C CAPACITOR	22pF 50V J		R12	NRSA63J-102X	MG RESISTOR	1kΩ 1/16W J	
C3025	QAT3725-300Z	TRIM CAPACITOR	30pF TIMER CLOCK		R21	NRSA63J-222X	MG RESISTOR	2.2kΩ 1/16W J	
C3027	QERF1CM-106Z	E CAPACITOR	10uF 16V M		R22	NRSA63J-222X	MG RESISTOR	2.2kΩ 1/16W J	
C3030	QERF1CM-476Z	E CAPACITOR	47uF 16V M		R35	NRSA63J-821X	MG RESISTOR	820Ω 1/16W J	EF
C3031	NCB31CK-104X	C CAPACITOR	0.1uF 16V K		R36	NRSA63J-472X	MG RESISTOR	4.7kΩ 1/16W J	
C3032	NCB31CK-104X	C CAPACITOR	0.1uF 16V K		R37	NRSA63J-103X	MG RESISTOR	10kΩ 1/16W J	
C3033	NCB31CK-104X	C CAPACITOR	0.1uF 16V K		R38	NRSA63J-685X	MG RESISTOR	6.8MΩ 1/16W J	
C3034	NDC31HJ-560X	C CAPACITOR	56pF 50V J		R41	NRSA63J-101X	MG RESISTOR	100Ω 1/16W J	
C3035	NDC31HJ-560X	C CAPACITOR	56pF 50V J		R42	QRE141J-471Y	C RESISTOR	470Ω 1/4W J	
C3036	NDC31HJ-180X	C CAPACITOR	18pF 50V J		R43	NRSA63J-471X	MG RESISTOR	470Ω 1/16W J	
C3037	NDC31HJ-120X	C CAPACITOR	12pF 50V J		R203	NRSA63J-331X	MG RESISTOR	330Ω 1/16W J	
C3042	QETJ0JM-477Z	E CAPACITOR	470uF 6.3V M		R204	NRSA63J-101X	MG RESISTOR	100Ω 1/16W J	
C3050	NCB31CK-104X	C CAPACITOR	0.1uF 16V K		R205	NRSA63J-0R0X	MG RESISTOR	0Ω 1/16W J	
C3054	NCB31CK-104X	C CAPACITOR	0.1uF 16V K		R206	NRSA63J-331X	MG RESISTOR	330Ω 1/16W J	
C3071	QEKJ1HM-336Z	E CAPACITOR	33uF 50V M		R207	NRSA63J-103X	MG RESISTOR	10kΩ 1/16W J	
C3602	QCBB1HK-104Y	C CAPACITOR	0.1uF 50V K		R208	NRSA63J-0R0X	MG RESISTOR	0Ω 1/16W J	
C4002	NCB31HK-103X	C CAPACITOR	0.01uF 50V K		R209	NRSA63J-103X	MG RESISTOR	10kΩ 1/16W J	
C4004	QERF1CM-226Z	E CAPACITOR	22uF 16V M		R210	NRSA63J-103X	MG RESISTOR	10kΩ 1/16W J	
C4005	NCB31HK-222X	C CAPACITOR	2200pF 50V K		R211	NRSA63J-103X	MG RESISTOR	10kΩ 1/16W J	
C4006	QERF0JM-476Z	E CAPACITOR	47uF 6.3V M		R212	NRSA63J-102X	MG RESISTOR	1kΩ 1/16W J	
C4008	NCB30JK-105X	C CAPACITOR	1uF 6.3V K		R213	NRSA63J-222X	MG RESISTOR	2.2kΩ 1/16W J	
C4009	NRSA63J-0R0X	MG RESISTOR	0Ω 1/16W J		R501	NRSA63J-0R0X	MG RESISTOR	0Ω 1/16W J	
C4010	NCB31EK-223X	C CAPACITOR	0.022uF 25V K		R502	NRSA63J-0R0X	MG RESISTOR	0Ω 1/16W J	
C4011	NCB31EK-104X	C CAPACITOR	0.1uF 25V K		R505	NRSA63J-0R0X	MG RESISTOR	0Ω 1/16W J	
C4012	NCB30JK-105X	C CAPACITOR	1uF 6.3V K		R506	NRSA63J-0R0X	MG RESISTOR	0Ω 1/16W J	
C4014	NDC31HJ-101X	C CAPACITOR	100pF 50V J		R507	NRSA63J-0R0X	MG RESISTOR	0Ω 1/16W J	
C4015	NCB31HK-102X	C CAPACITOR	1000pF 50V K		R508	NRSA63J-0R0X	MG RESISTOR	0Ω 1/16W J	
C4018	NCB31HK-102X	C CAPACITOR	1000pF 50V K		R509	NRSA63J-0R0X	MG RESISTOR	0Ω 1/16W J	
C4031	QEKJ1CM-336Z	E CAPACITOR	33uF 16V M		R510	NRSA63J-0R0X	MG RESISTOR	0Ω 1/16W J	
C4201	QEKJ0JM-227Z	E CAPACITOR	220uF 6.3V M		R513	NRSA63J-0R0X	MG RESISTOR	0Ω 1/16W J	
C4202	NCB31EK-103X	C CAPACITOR	0.01uF 25V K		R514	NRSA63J-0R0X	MG RESISTOR	0Ω 1/16W J	
C4203	NCB30JK-105X	C CAPACITOR	1uF 6.3V K		R521	NRSA63J-101X	MG RESISTOR	100Ω 1/16W J	
C4204	NCB30JK-105X	C CAPACITOR	1uF 6.3V K		R522	NRSA63J-102X	MG RESISTOR	1kΩ 1/16W J	
C4205	NDC31HJ-180X	C CAPACITOR	18pF 50V J		R523	NRSA63J-102X	MG RESISTOR	1kΩ 1/16W J	
C4206	NDC31HJ-220X	C CAPACITOR	22pF 50V J		R524	NRSA63J-473X	MG RESISTOR	47kΩ 1/16W J	
C4207	NCB31CK-563X	C CAPACITOR	0.056uF 16V K		R525	NRSA63J-473X	MG RESISTOR	47kΩ 1/16W J	
C4208	QEKJ1HM-475Z	E CAPACITOR	4.7uF 50V M		R526	NRSA63J-471X	MG RESISTOR	470Ω 1/16W J	
C4209	NCB31AK-224X	C CAPACITOR	0.22uF 10V K		R528	NRSA63J-0R0X	MG RESISTOR	0Ω 1/16W J	
C4210	QEKJ0JM-227Z	E CAPACITOR	220uF 6.3V M		R529	NRSA63J-221X	MG RESISTOR	220Ω 1/16W J	
C4216	NCB31CK-104X	C CAPACITOR	0.1uF 16V K						

△ Symbol No.	Part No.	Part Name	Description	Local	△ Symbol No.	Part No.	Part Name	Description	Local
R530	NRSA63J-221X	MG RESISTOR	220Ω 1/16W J		R2612	NRSA63J-103X	MG RESISTOR	10kΩ 1/16W J	
R531	NRSA63J-0R0X	MG RESISTOR	0Ω 1/16W J		R2613	NRSA63J-103X	MG RESISTOR	10kΩ 1/16W J	
R532	QRE141J-394Y	C RESISTOR	390kΩ 1/4W J		R2614	NRSA63J-103X	MG RESISTOR	10kΩ 1/16W J	
R2003	NRSA63J-101X	MG RESISTOR	100Ω 1/16W J		R2615	NRSA63J-103X	MG RESISTOR	10kΩ 1/16W J	
R2005	NRSA63J-153X	MG RESISTOR	15kΩ 1/16W J		R2618	NRSA63J-472X	MG RESISTOR	4.7kΩ 1/16W J	
R2007	NRSA63J-183X	MG RESISTOR	18kΩ 1/16W J		R2619	NRSA63J-472X	MG RESISTOR	4.7kΩ 1/16W J	
R2008	NRSA63J-103X	MG RESISTOR	10kΩ 1/16W J		R2620	NRSA63J-473X	MG RESISTOR	47kΩ 1/16W J	
R2010	NRSA63J-123X	MG RESISTOR	12kΩ 1/16W J		R2621	QRE141J-331Y	C RESISTOR	330Ω 1/4W J	
R2013	NRSA63J-123X	MG RESISTOR	12kΩ 1/16W J		R2622	QRE141J-331Y	C RESISTOR	330Ω 1/4W J	
R2014	NRSA63J-394X	MG RESISTOR	390kΩ 1/16W J		R2631	NRSA63J-102X	MG RESISTOR	1kΩ 1/16W J	
R2015	NRSA63J-271X	MG RESISTOR	270Ω 1/16W J		R2632	NRSA63J-471X	MG RESISTOR	470Ω 1/16W J	
R2016	NRSA63J-333X	MG RESISTOR	33kΩ 1/16W J		R2633	NRSA63J-471X	MG RESISTOR	470Ω 1/16W J	
R2017	NRSA63J-223X	MG RESISTOR	22kΩ 1/16W J		R2634	NRSA63J-103X	MG RESISTOR	10kΩ 1/16W J	
R2018	NRSA63J-472X	MG RESISTOR	4.7kΩ 1/16W J		R2635	NRSA63J-103X	MG RESISTOR	10kΩ 1/16W J	
R2019	NRSA63J-472X	MG RESISTOR	4.7kΩ 1/16W J		R2636	NRSA63J-472X	MG RESISTOR	4.7kΩ 1/16W J	
R2021	NRSA63J-333X	MG RESISTOR	33kΩ 1/16W J		R2637	NRSA63J-472X	MG RESISTOR	4.7kΩ 1/16W J	
R2022	NRSA63J-103X	MG RESISTOR	10kΩ 1/16W J		R2652	NRSA63J-0R0X	MG RESISTOR	0Ω 1/16W J	
R2023	NRSA63J-103X	MG RESISTOR	10kΩ 1/16W J		R2653	NRSA63J-103X	MG RESISTOR	10kΩ 1/16W J	
R2053	NRSA63J-123X	MG RESISTOR	12kΩ 1/16W J		R2654	NRSA63J-153X	MG RESISTOR	15kΩ 1/16W J	
R2054	NRSA63J-123X	MG RESISTOR	12kΩ 1/16W J		R2655	NRSA63J-223X	MG RESISTOR	22kΩ 1/16W J	
R2055	NRSA63J-3R3X	MG RESISTOR	3.3Ω 1/16W J		R2656	NRSA63J-223X	MG RESISTOR	22kΩ 1/16W J	
R2056	QRE141J-820Y	C RESISTOR	82Ω 1/4W J		R2657	NRSA63J-223X	MG RESISTOR	22kΩ 1/16W J	
R2057	NRSA63J-473X	MG RESISTOR	47kΩ 1/16W J		R2658	NRSA63J-103X	MG RESISTOR	10kΩ 1/16W J	
R2058	NRSA63J-183X	MG RESISTOR	18kΩ 1/16W J		R2659	NRSA63J-103X	MG RESISTOR	10kΩ 1/16W J	
R2059	NRSA63J-473X	MG RESISTOR	47kΩ 1/16W J		R2660	NRSA63J-103X	MG RESISTOR	10kΩ 1/16W J	
R2060	NRSA63J-183X	MG RESISTOR	18kΩ 1/16W J		R2661	NRSA63J-103X	MG RESISTOR	10kΩ 1/16W J	
R2201	NRSA63J-473X	MG RESISTOR	47kΩ 1/16W J		R2662	NRSA63J-223X	MG RESISTOR	22kΩ 1/16W J	
R2202	NRSA63J-682X	MG RESISTOR	6.8kΩ 1/16W J		R2663	NRSA63J-223X	MG RESISTOR	22kΩ 1/16W J	
R2203	NRSA63J-473X	MG RESISTOR	47kΩ 1/16W J		R2666	NRSA63J-473X	MG RESISTOR	47kΩ 1/16W J	
R2204	NRSA63J-682X	MG RESISTOR	6.8kΩ 1/16W J		R3011	NRSA63J-0R0X	MG RESISTOR	0Ω 1/16W J	
R2205	NRSA63J-473X	MG RESISTOR	47kΩ 1/16W J		R3012	NRSA63J-102X	MG RESISTOR	1kΩ 1/16W J	EF
R2206	NRSA63J-682X	MG RESISTOR	6.8kΩ 1/16W J		R3013	QRE141J-472Y	C RESISTOR	4.7kΩ 1/4W J	
R2207	NRSA63J-473X	MG RESISTOR	47kΩ 1/16W J		R3016	QRE141J-472Y	C RESISTOR	4.7kΩ 1/4W J	
R2208	NRSA63J-682X	MG RESISTOR	6.8kΩ 1/16W J		R3017	QRE141J-472Y	C RESISTOR	4.7kΩ 1/4W J	
R2209	NRSA63J-681X	MG RESISTOR	680Ω 1/16W J		R3018	NRSA63J-0R0X	MG RESISTOR	0Ω 1/16W J	
R2210	NRSA63J-472X	MG RESISTOR	4.7kΩ 1/16W J		R3019	NRSA63J-682X	MG RESISTOR	6.8kΩ 1/16W J	
R2211	NRSA63J-272X	MG RESISTOR	2.7kΩ 1/16W J		R3021	NRSA63J-0R0X	MG RESISTOR	0Ω 1/16W J	
R2212	NRSA63J-272X	MG RESISTOR	2.7kΩ 1/16W J		R3022	NRSA63J-0R0X	MG RESISTOR	0Ω 1/16W J	
R2213	NRSA63J-472X	MG RESISTOR	4.7kΩ 1/16W J		R3025	QRE141J-102Y	C RESISTOR	1kΩ 1/4W J	
R2214	NRSA63J-681X	MG RESISTOR	680Ω 1/16W J		R3026	QRE141J-102Y	C RESISTOR	1kΩ 1/4W J	
R2215	NRSA63J-0R0X	MG RESISTOR	0Ω 1/16W J		R3027	NRSA63J-0R0X	MG RESISTOR	0Ω 1/16W J	
R2218	NRSA63J-332X	MG RESISTOR	3.3kΩ 1/16W J		R3029	NRSA63J-472X	MG RESISTOR	4.7kΩ 1/16W J	
R2219	NRSA63J-122X	MG RESISTOR	1.2kΩ 1/16W J		R3030	NRSA63J-102X	MG RESISTOR	1kΩ 1/16W J	
R2220	NRSA63J-102X	MG RESISTOR	1kΩ 1/16W J		R3031	NRSA63J-0R0X	MG RESISTOR	0Ω 1/16W J	
R2222	NRSA63J-472X	MG RESISTOR	4.7kΩ 1/16W J		R3032	NRSA63J-101X	MG RESISTOR	100Ω 1/16W J	
R2223	NRSA63J-511X	MG RESISTOR	510Ω 1/16W J		R3034	NRSA63J-0R0X	MG RESISTOR	0Ω 1/16W J	
R2224	NRSA63J-511X	MG RESISTOR	510Ω 1/16W J		R3035	NRSA63J-0R0X	MG RESISTOR	0Ω 1/16W J	
R2225	NRSA63J-472X	MG RESISTOR	4.7kΩ 1/16W J		R3036	NRSA63J-472X	MG RESISTOR	4.7kΩ 1/16W J	
R2226	NRSA63J-473X	MG RESISTOR	47kΩ 1/16W J		R3037	NRSA63J-0R0X	MG RESISTOR	0Ω 1/16W J	
R2227	NRSA63J-912X	MG RESISTOR	9.1kΩ 1/16W J		R3038	NRSA63J-182X	MG RESISTOR	1.8kΩ 1/16W J	
R2228	NRSA63J-473X	MG RESISTOR	47kΩ 1/16W J		R3039	NRSA63J-0R0X	MG RESISTOR	0Ω 1/16W J	
R2229	NRSA63J-912X	MG RESISTOR	9.1kΩ 1/16W J		R3040	NRSA63J-0R0X	MG RESISTOR	0Ω 1/16W J	
R2230	NRSA63J-473X	MG RESISTOR	47kΩ 1/16W J		R3041	NRSA63J-0R0X	MG RESISTOR	0Ω 1/16W J	
R2231	NRSA63J-682X	MG RESISTOR	6.8kΩ 1/16W J		R3042	NRSA63J-102X	MG RESISTOR	1kΩ 1/16W J	
R2232	NRSA63J-473X	MG RESISTOR	47kΩ 1/16W J		R3044	NRSA63J-0R0X	MG RESISTOR	0Ω 1/16W J	
R2233	NRSA63J-682X	MG RESISTOR	6.8kΩ 1/16W J		R3046	NRSA63J-0R0X	MG RESISTOR	0Ω 1/16W J	
R2234	NRSA63J-101X	MG RESISTOR	100Ω 1/16W J		R3047	NRSA63J-0R0X	MG RESISTOR	0Ω 1/16W J	
R2239	NRSA63J-0R0X	MG RESISTOR	0Ω 1/16W J		R3048	NRSA63J-0R0X	MG RESISTOR	0Ω 1/16W J	
R2240	NRSA63J-0R0X	MG RESISTOR	0Ω 1/16W J		R3049	NRSA63J-0R0X	MG RESISTOR	0Ω 1/16W J	
R2241	NRSA63J-473X	MG RESISTOR	47kΩ 1/16W J		R3050	NRSA63J-0R0X	MG RESISTOR	0Ω 1/16W J	
R2242	NRSA63J-682X	MG RESISTOR	6.8kΩ 1/16W J		R3051	NRSA63J-471X	MG RESISTOR	470Ω 1/16W J	
R2243	NRSA63J-473X	MG RESISTOR	47kΩ 1/16W J		R3052	NRSA63J-471X	MG RESISTOR	470Ω 1/16W J	
R2244	NRSA63J-682X	MG RESISTOR	6.8kΩ 1/16W J		R3053	NRSA63J-471X	MG RESISTOR	470Ω 1/16W J	
R2251	NRSA63J-472X	MG RESISTOR	4.7kΩ 1/16W J		R3054	NRSA63J-102X	MG RESISTOR	1kΩ 1/16W J	
R2252	NRSA63J-221X	MG RESISTOR	220Ω 1/16W J		R3055	NRSA63J-102X	MG RESISTOR	1kΩ 1/16W J	
R2253	NRSA63J-101X	MG RESISTOR	100Ω 1/16W J		R3056	NRSA63J-0R0X	MG RESISTOR	0Ω 1/16W J	
R2255	NRSA63J-273X	MG RESISTOR	27kΩ 1/16W J		R3057	NRSA63J-101X	MG RESISTOR	100Ω 1/16W J	
R2601	NRSA63J-101X	MG RESISTOR	100Ω 1/16W J		R3059	NRSA63J-102X	MG RESISTOR	1kΩ 1/16W J	
R2602	NRSA63J-332X	MG RESISTOR	3.3kΩ 1/16W J		R3060	NRSA63J-471X	MG RESISTOR	470Ω 1/16W J	
R2603	NRSA63J-102X	MG RESISTOR	1kΩ 1/16W J		R3061	NRSA63J-471X	MG RESISTOR	470Ω 1/16W J	
R2604	NRSA63J-273X	MG RESISTOR	27kΩ 1/16W J		R3062	NRSA63J-103X	MG RESISTOR	10kΩ 1/16W J	
R2605	NRSA63J-273X	MG RESISTOR	27kΩ 1/16W J		R3063	NRSA63J-472X	MG RESISTOR	4.7kΩ 1/16W J	
R2606	NRSA63J-102X	MG RESISTOR	1kΩ 1/16W J		R3066	NRSA63J-472X	MG RESISTOR	4.7kΩ 1/16W J	
R2607	NRSA63J-332X	MG RESISTOR	3.3kΩ 1/16W J		R3069	NRSA63J-101X	MG RESISTOR	100Ω 1/16W J	
R2608	NRSA63J-101X	MG RESISTOR	100Ω 1/16W J		R3071	NRSA63J-103X	MG RESISTOR	10kΩ 1/16W J	
R2609	NRSA63J-102X	MG RESISTOR	1kΩ 1/16W J		R3075	NRSA63J-471X	MG RESISTOR	470Ω 1/16W J	
R2610	NRSA63J-101X	MG RESISTOR	100Ω 1/16W J		R3076	NRSA63J-471X	MG RESISTOR	470Ω 1/16W J	
R2611	NRSA63J-101X	MG RESISTOR	100Ω 1/16W J		R3077	NRSA63J-471X	MG RESISTOR	470Ω 1/16W J	EF

△ Symbol No.	Part No.	Part Name	Description	Local	△ Symbol No.	Part No.	Part Name	Description	Local
R3078	QRE141J-102Y	C RESISTOR	1kΩ 1/4W J		R4206	NRSA63J-103X	MG RESISTOR	10kΩ 1/16W J	
R3079	NRSA63J-471X	MG RESISTOR	470Ω 1/16W J		R4209	NRSA63J-103X	MG RESISTOR	10kΩ 1/16W J	
R3080	QRE141J-102Y	C RESISTOR	1kΩ 1/4W J		R4210	NRSA63J-272X	MG RESISTOR	2.7kΩ 1/16W J	
R3081	QRE141J-102Y	C RESISTOR	1kΩ 1/4W J		R4211	NRSA63J-562X	MG RESISTOR	5.6kΩ 1/16W J	
R3083	NRSA63J-102X	MG RESISTOR	1kΩ 1/16W J		R4215	NRSA63J-101X	MG RESISTOR	100Ω 1/16W J	
R3085	NRSA63J-0R0X	MG RESISTOR	0Ω 1/16W J		R4216	NRSA63J-102X	MG RESISTOR	1kΩ 1/16W J	
R3086	NRSA63J-0R0X	MG RESISTOR	0Ω 1/16W J		R4304	NRSA63J-103X	MG RESISTOR	10kΩ 1/16W J	EF
R3087	QRE141J-102Y	C RESISTOR	1kΩ 1/4W J		R4305	NRSA63J-223X	MG RESISTOR	22kΩ 1/16W J	EF
R3089	NRSA63J-471X	MG RESISTOR	470Ω 1/16W J		R4306	NRSA63J-122X	MG RESISTOR	1.2kΩ 1/16W J	EF
R3090	NRSA63J-102X	MG RESISTOR	1kΩ 1/16W J		R4307	NRSA63J-223X	MG RESISTOR	22kΩ 1/16W J	EF
R3091	QRE141J-102Y	C RESISTOR	1kΩ 1/4W J		R4308	NRSA63J-562X	MG RESISTOR	5.6kΩ 1/16W J	EF
R3092	NRSA63J-102X	MG RESISTOR	1kΩ 1/16W J		R4309	NRSA63J-222X	MG RESISTOR	2.2kΩ 1/16W J	EF
R3093	NRSA63J-102X	MG RESISTOR	1kΩ 1/16W J		R4310	NRSA63J-822X	MG RESISTOR	8.2kΩ 1/16W J	EF
R3094	NRSA63J-102X	MG RESISTOR	1kΩ 1/16W J		R4311	NRSA63J-123X	MG RESISTOR	12kΩ 1/16W J	EF
R3095	QRE141J-102Y	C RESISTOR	1kΩ 1/4W J		R4313	NRSA63J-0R0X	MG RESISTOR	0Ω 1/16W J	EF
R3096	NRSA63J-102X	MG RESISTOR	1kΩ 1/16W J		R4317	NRSA63J-223X	MG RESISTOR	22kΩ 1/16W J	EF
R3097	NRSA63J-102X	MG RESISTOR	1kΩ 1/16W J		R4318	NRSA63J-103X	MG RESISTOR	10kΩ 1/16W J	EF
R3103	NRSA63J-101X	MG RESISTOR	100Ω 1/16W J		R4319	NRSA63J-123X	MG RESISTOR	12kΩ 1/16W J	EF
R3104	NRSA63J-102X	MG RESISTOR	1kΩ 1/16W J		R4320	QRE141J-0R0Z	C RESISTOR	0Ω 1/4W J	EF
R3106	NRSA63J-102X	MG RESISTOR	1kΩ 1/16W J		R6001	NRSA63J-470X	MG RESISTOR	47Ω 1/16W J	
R3107	NRSA02J-102X	MG RESISTOR	1kΩ 1/10W J	EF	R6002	NRSA63J-101X	MG RESISTOR	100Ω 1/16W J	
R3205	QRE141J-181Y	C RESISTOR	180Ω 1/4W J		R6020	NRSA63J-102X	MG RESISTOR	1kΩ 1/16W J	
R3206	NRSA63J-123X	MG RESISTOR	12kΩ 1/16W J		R6021	NRSA63J-102X	MG RESISTOR	1kΩ 1/16W J	
R3207	NRSA63J-183X	MG RESISTOR	18kΩ 1/16W J		R6022	NRSA63J-102X	MG RESISTOR	1kΩ 1/16W J	
R3208	NRSA63J-121X	MG RESISTOR	120Ω 1/16W J		R6030	NRSA63J-102X	MG RESISTOR	1kΩ 1/16W J	
R3209	NRSA63J-183X	MG RESISTOR	18kΩ 1/16W J		R6031	NRSA63J-101X	MG RESISTOR	100Ω 1/16W J	
R3210	NRSA63J-121X	MG RESISTOR	120Ω 1/16W J		R6032	NRSA63J-332X	MG RESISTOR	3.3kΩ 1/16W J	EF
R3211	NRSA63J-183X	MG RESISTOR	18kΩ 1/16W J		R6032	NRSA63J-182X	MG RESISTOR	1.8kΩ 1/16W J	E,EK
R3212	QRE141J-474Y	C RESISTOR	470kΩ 1/4W J		R6033	NRSA63J-182X	MG RESISTOR	1.8kΩ 1/16W J	EF
R3213	NRSA63J-334X	MG RESISTOR	330kΩ 1/16W J		R6033	NRSA63J-272X	MG RESISTOR	2.7kΩ 1/16W J	E,EK
R3214	NRSA63J-103X	MG RESISTOR	10kΩ 1/16W J		R6080	NRSA63J-103X	MG RESISTOR	10kΩ 1/16W J	
R3215	NRSA63J-103X	MG RESISTOR	10kΩ 1/16W J		R7101	NRSA63J-103X	MG RESISTOR	10kΩ 1/16W J	
R3216	NRSA63J-103X	MG RESISTOR	10kΩ 1/16W J		R7102	NRSA63J-822X	MG RESISTOR	8.2kΩ 1/16W J	
R3217	NRSA63J-103X	MG RESISTOR	10kΩ 1/16W J		R7301	NRSA63J-221X	MG RESISTOR	220Ω 1/16W J	
R3218	NRSA63J-472X	MG RESISTOR	4.7kΩ 1/16W J		R7302	NRSA63J-221X	MG RESISTOR	220Ω 1/16W J	
R3219	NRSA63J-472X	MG RESISTOR	4.7kΩ 1/16W J		R7303	NRSA63J-472X	MG RESISTOR	4.7kΩ 1/16W J	
R3220	NRSA63J-104X	MG RESISTOR	100kΩ 1/16W J		R7304	NRSA63J-472X	MG RESISTOR	4.7kΩ 1/16W J	
R3222	NRSA63J-103X	MG RESISTOR	10kΩ 1/16W J		R7305	NRSA63J-102X	MG RESISTOR	1kΩ 1/16W J	
R3223	NRSA63J-472X	MG RESISTOR	4.7kΩ 1/16W J		R7306	NRSA63J-472X	MG RESISTOR	4.7kΩ 1/16W J	
R3224	NRSA63J-472X	MG RESISTOR	4.7kΩ 1/16W J		R7307	NRSA63J-102X	MG RESISTOR	1kΩ 1/16W J	
R3229	NRSA63J-105X	MG RESISTOR	1MΩ 1/16W J		R7308	NRSA63J-221X	MG RESISTOR	220Ω 1/16W J	
R3230	NRSA63J-472X	MG RESISTOR	4.7kΩ 1/16W J		R7309	NRSA63J-221X	MG RESISTOR	220Ω 1/16W J	
R3231	NRSA63J-102X	MG RESISTOR	1kΩ 1/16W J		R7310	QRE121J-151Y	C RESISTOR	150Ω 1/2W J	
R3235	NRSA63J-332X	MG RESISTOR	3.3kΩ 1/16W J		R7501	NRSA63J-4R7X	MG RESISTOR	4.7Ω 1/16W J	
R3236	NRSA63J-332X	MG RESISTOR	3.3kΩ 1/16W J		R7502	NRSA63J-561X	MG RESISTOR	560Ω 1/16W J	
R3237	NRSA63J-103X	MG RESISTOR	10kΩ 1/16W J		R7503	NRSA63J-561X	MG RESISTOR	560Ω 1/16W J	
R3241	NRSA63J-104X	MG RESISTOR	100kΩ 1/16W J		R7504	NRSA63J-820X	MG RESISTOR	82Ω 1/16W J	
R3250	NRSA63J-0R0X	MG RESISTOR	0Ω 1/16W J	E,EK	R7505	NRSA63J-100X	MG RESISTOR	10Ω 1/16W J	
R3253	NRSA63J-103X	MG RESISTOR	10kΩ 1/16W J		R7506	NRSA63J-100X	MG RESISTOR	10Ω 1/16W J	
R3258	NRSA63J-103X	MG RESISTOR	10kΩ 1/16W J		R7507	NRSA63J-561X	MG RESISTOR	560Ω 1/16W J	
R3259	NRSA63J-472X	MG RESISTOR	4.7kΩ 1/16W J		L2	QQL071J-221Y	COIL	220uH J	EF
R3260	NRSA63J-103X	MG RESISTOR	10kΩ 1/16W J		L3	QQL29BJ-100Z	P COIL	10uH J	
R3261	NRSA63J-103X	MG RESISTOR	10kΩ 1/16W J		L5	QQL29BJ-100Z	P COIL	10uH J	
R3262	NRSA63J-103X	MG RESISTOR	10kΩ 1/16W J		L6	QQL29BJ-100Z	P COIL	10uH J	
R3263	NRSA63J-103X	MG RESISTOR	10kΩ 1/16W J		L7	QQR0967-001	CHOKE COIL		
R3264	NRSA63J-103X	MG RESISTOR	10kΩ 1/16W J		L10	QQL29BJ-100Z	P COIL	10uH J	
R3601	NRSA63J-222X	MG RESISTOR	2.2kΩ 1/16W J		L14	QQL071J-101Y	COIL	100uH J	EF
R3607	NRSA63J-103X	MG RESISTOR	10kΩ 1/16W J		L201	QQL29BJ-100Z	P COIL	10uH J	
R3608	NRSA63J-222X	MG RESISTOR	2.2kΩ 1/16W J		L202	QQL071J-220Y	COIL	22uH J	
R3610	NRSA63J-222X	MG RESISTOR	2.2kΩ 1/16W J		L203	QQL071J-220Y	COIL	22uH J	
R3611	NRSA63J-222X	MG RESISTOR	2.2kΩ 1/16W J		L501	QQL29BJ-100Z	P COIL	10uH J	
R3612	NRSA63J-103X	MG RESISTOR	10kΩ 1/16W J		L502	QQL29BJ-100Z	P COIL	10uH J	
R4001	NRSA63J-472X	MG RESISTOR	4.7kΩ 1/16W J		L2251	QQL29BJ-100Z	P COIL	10uH J	
R4003	NRSA63J-561X	MG RESISTOR	560Ω 1/16W J		L2252	QQL29BJ-151Z	P COIL	150uH J	
R4004	NRSA63J-561X	MG RESISTOR	560Ω 1/16W J		△ L3001	QQL231J-R22Y	COIL	0.22uH J	
R4005	NRSA63J-562X	MG RESISTOR	5.6kΩ 1/16W J		L4201	QQL29BJ-100Z	P COIL	10uH J	
R4007	NRSA63J-102X	MG RESISTOR	1kΩ 1/16W J		L4301	QQL29BJ-100Z	P COIL	10uH J	EF
R4008	NRSA63J-102X	MG RESISTOR	1kΩ 1/16W J		L6002	QQL29BK-1R0Z	P COIL	1uH K	
R4009	NRSA63J-102X	MG RESISTOR	1kΩ 1/16W J		L6003	QQL29BK-1R0Z	P COIL	1uH K	
R4010	NRSA63J-222X	MG RESISTOR	2.2kΩ 1/16W J		L6005	QQL231J-5R6Y	COIL	5.6uH J	
R4012	NRSA63J-222X	MG RESISTOR	2.2kΩ 1/16W J		L6701	QQL29BJ-3R3Z	P COIL	3.3uH J	
R4013	NRSA63J-102X	MG RESISTOR	1kΩ 1/16W J		L7301	QQL29BJ-100Z	P COIL	10uH J	
R4015	NRSA63J-562X	MG RESISTOR	5.6kΩ 1/16W J		L7501	QQL29BK-1R0Z	P COIL	1uH K	
R4017	NRSA63J-102X	MG RESISTOR	1kΩ 1/16W J		T2051	QQR0002-001	BIAS COIL		
R4127	NRSA63J-102X	MG RESISTOR	1kΩ 1/16W J		B1	NRSA63J-0R0X	MG RESISTOR	0Ω 1/16W J	
R4128	NRSA63J-102X	MG RESISTOR	1kΩ 1/16W J		B4	NRSA63J-0R0X	MG RESISTOR	0Ω 1/16W J	
R4203	NRSA63J-103X	MG RESISTOR	10kΩ 1/16W J						
R4204	NRSA63J-0R0X	MG RESISTOR	0Ω 1/16W J						

△ Symbol No.	Part No.	Part Name	Description	Local	△ Symbol No.	Part No.	Part Name	Description	Local
B7	NRSA63J-0R0X	MG RESISTOR	0Ω 1/16W J		W36	NRSA63J-0R0X	MG RESISTOR	0Ω 1/16W J	
B9	NRSA63J-0R0X	MG RESISTOR	0Ω 1/16W J		W37	NRSA63J-0R0X	MG RESISTOR	0Ω 1/16W J	
B13	NRSA63J-0R0X	MG RESISTOR	0Ω 1/16W J	EF	W38	NRSA63J-0R0X	MG RESISTOR	0Ω 1/16W J	
B202	NRSA63J-0R0X	MG RESISTOR	0Ω 1/16W J		W39	NRSA63J-0R0X	MG RESISTOR	0Ω 1/16W J	
B501	NRSA63J-0R0X	MG RESISTOR	0Ω 1/16W J		W41	NRSA63J-0R0X	MG RESISTOR	0Ω 1/16W J	
B503	NRSA63J-0R0X	MG RESISTOR	0Ω 1/16W J		W42	NRSA63J-0R0X	MG RESISTOR	0Ω 1/16W J	
B505	NRSA63J-332X	MG RESISTOR	3.3kΩ 1/16W J		W44	NRSA63J-0R0X	MG RESISTOR	0Ω 1/16W J	
B7111	NRSA63J-0R0X	MG RESISTOR	0Ω 1/16W J		W45	NRSA63J-0R0X	MG RESISTOR	0Ω 1/16W J	
B7112	NRSA63J-0R0X	MG RESISTOR	0Ω 1/16W J		W46	NRSA63J-0R0X	MG RESISTOR	0Ω 1/16W J	
B7113	NRSA63J-0R0X	MG RESISTOR	0Ω 1/16W J		W47	NRSA63J-0R0X	MG RESISTOR	0Ω 1/16W J	
B7114	NRSA63J-0R0X	MG RESISTOR	0Ω 1/16W J		W48	NRSA63J-0R0X	MG RESISTOR	0Ω 1/16W J	
B7502	NRSA63J-0R0X	MG RESISTOR	0Ω 1/16W J		W49	NRSA63J-0R0X	MG RESISTOR	0Ω 1/16W J	
CN1	QGF1201C2-09	CONNECTOR	FFC/FPC (1-9)		W50	NRSA63J-0R0X	MG RESISTOR	0Ω 1/16W J	
CN501	QGF1207C1-04	CONNECTOR	FFC/FPC (1-4)		W51	NRSA63J-0R0X	MG RESISTOR	0Ω 1/16W J	
CN2001	QGF1207C1-06	CONNECTOR	FFC/FPC (1-6)		W52	NRSA63J-0R0X	MG RESISTOR	0Ω 1/16W J	
CN2002	QGB2532J1-02	CONNECTOR	B-B (1-2)		W53	NRSA63J-0R0X	MG RESISTOR	0Ω 1/16W J	
CN2601	QGB1231L1-11	CONNECTOR	B-B (1-11)		W54	NRSA63J-0R0X	MG RESISTOR	0Ω 1/16W J	
CN3001	QGB2032M4-12	CONNECTOR	B-B (1-12)		W55	NRSA63J-0R0X	MG RESISTOR	0Ω 1/16W J	
CN3102	QGF1207C1-15	CONNECTOR	FFC/FPC (1-15)		W56	NRSA63J-0R0X	MG RESISTOR	0Ω 1/16W J	
CN3103	QGB1231L1-19	CONNECTOR	B-B (1-19)		W57	NRSA63J-0R0X	MG RESISTOR	0Ω 1/16W J	
CN3901	QGF1207C1-06	CONNECTOR	FFC/FPC (1-6)		W58	NRSA63J-0R0X	MG RESISTOR	0Ω 1/16W J	
CN4401	LPA10291-01B	RGB_YC BOARD ASSY			WR2	QRE141J-0R0Z	C RESISTOR	0Ω 1/4W J	
CN5311	QGF1207C1-15	CONNECTOR	FFC/FPC (1-15)		X1	QAX0740-001	CRYSTAL	4.433619MHz	
CN6701	LPA10292-04A	DEMOM BOARD ASSY		EF	X3001	QAX0444-001	CRYSTAL	32.768kHz	
CN7111	QGF1207C1-13	CONNECTOR	FFC/FPC (1-13)		X3002	QAX0527-001	CRYSTAL	10.000000MHz	
CN7112	QGF1207C1-09	CONNECTOR	FFC/FPC (1-9)		X4201	QAX0849-001	CRYSTAL	4.433619MHz	
CN7113	QGB2024K1-13S	CONNECTOR	B-B (1-13)		OT1	LP31158-001A	BOSS(MECHA) 1		
CN7114	QGB2024K1-15S	CONNECTOR	B-B (1-15)		OT2	LP31185-001A	BOSS(MECHA) 2 (x2)		
CN7115	QGB2024K1-17S	CONNECTOR	B-B (1-17)		SD1	LP31179-001A	SHILD PLATE(PRE/REC)		
CN7119	LPA10011-03A	SECAM BOARD ASSY		EF					
△ CP3002	QMFZ050-1R25X-E	FUSE	1.25A 125V						
△ CP4002	QMFZ050-1R25X-E	FUSE	1.25A 125V						
J7009	QNN0096-001	PIN JACK	COAX OUT						
J7301	QNS0259-001	3.5 JACK	G-LINK						
JS3001	NSW0238-001	ROTARY ENCODER							
K2001	NRSA63J-0R0X	MG RESISTOR	0Ω 1/16W J						
K2002	NRSA63J-0R0X	MG RESISTOR	0Ω 1/16W J						
K2003	NRSA63J-0R0X	MG RESISTOR	0Ω 1/16W J						
K2004	NRSA63J-0R0X	MG RESISTOR	0Ω 1/16W J						
K2251	NRSA63J-0R0X	MG RESISTOR	0Ω 1/16W J						
K2252	NRSA63J-0R0X	MG RESISTOR	0Ω 1/16W J						
K7501	NQR0147-004X	FERRITE BEADS							
K7503	NQR0147-004X	FERRITE BEADS							
S3001	QSW0602-004	PUSH SWITCH	REC SAFE						
TU6001	QAU0402-002	TUNER							
TU6001	QAU0401-001	TUNER		EF					
W1	NRSA63J-0R0X	MG RESISTOR	0Ω 1/16W J	E,EK					
W2	NRSA63J-0R0X	MG RESISTOR	0Ω 1/16W J						
W3	NRSA63J-0R0X	MG RESISTOR	0Ω 1/16W J						
W4	NRSA63J-0R0X	MG RESISTOR	0Ω 1/16W J						
W5	NRSA63J-0R0X	MG RESISTOR	0Ω 1/16W J						
W6	NRSA63J-0R0X	MG RESISTOR	0Ω 1/16W J						
W7	NRSA63J-0R0X	MG RESISTOR	0Ω 1/16W J						
W8	NRSA63J-0R0X	MG RESISTOR	0Ω 1/16W J						
W9	NRSA63J-0R0X	MG RESISTOR	0Ω 1/16W J						
W10	NRSA63J-0R0X	MG RESISTOR	0Ω 1/16W J						
W14	NRSA63J-0R0X	MG RESISTOR	0Ω 1/16W J						
W15	NRSA63J-0R0X	MG RESISTOR	0Ω 1/16W J						
W16	NRSA63J-0R0X	MG RESISTOR	0Ω 1/16W J						
W17	NRSA63J-0R0X	MG RESISTOR	0Ω 1/16W J						
W18	NRSA63J-0R0X	MG RESISTOR	0Ω 1/16W J						
W19	NRSA63J-0R0X	MG RESISTOR	0Ω 1/16W J						
W20	NRSA63J-0R0X	MG RESISTOR	0Ω 1/16W J						
W21	NRSA63J-0R0X	MG RESISTOR	0Ω 1/16W J						
W22	NRSA63J-0R0X	MG RESISTOR	0Ω 1/16W J						
W23	NRSA63J-0R0X	MG RESISTOR	0Ω 1/16W J						
W24	NRSA63J-0R0X	MG RESISTOR	0Ω 1/16W J						
W25	NRSA63J-0R0X	MG RESISTOR	0Ω 1/16W J						
W26	NRSA63J-0R0X	MG RESISTOR	0Ω 1/16W J						
W27	NRSA63J-0R0X	MG RESISTOR	0Ω 1/16W J						
W28	NRSA63J-0R0X	MG RESISTOR	0Ω 1/16W J						
W29	NRSA63J-0R0X	MG RESISTOR	0Ω 1/16W J						
W30	NRSA63J-0R0X	MG RESISTOR	0Ω 1/16W J						
W31	NRSA63J-0R0X	MG RESISTOR	0Ω 1/16W J						
W32	NRSA63J-0R0X	MG RESISTOR	0Ω 1/16W J						
W33	NRSA63J-0R0X	MG RESISTOR	0Ω 1/16W J						
W34	NRSA63J-0R0X	MG RESISTOR	0Ω 1/16W J						
W35	NRSA63J-0R0X	MG RESISTOR	0Ω 1/16W J						

## Terminal board

Block No. [0][6]

△ Symbol No.	Part No.	Part Name	Description	Local
PW1	LPA10296-01B	TERMINAL BOARD ASSY		
IC901	HA118226F	IC		
IC902	BA7623F-X	IC		
Q901	2SC2412K/QRS/-X	TRANSISTOR		
Q901	or 2SD601A/QRS/-X	TRANSISTOR		
Q901	or 2SC3928A/QRS/-X	TRANSISTOR		
Q902	2SC2412K/QRS/-X	TRANSISTOR		
Q902	or 2SD601A/QRS/-X	TRANSISTOR		
Q902	or 2SC3928A/QRS/-X	TRANSISTOR		
Q903	DTC144WKA-X	DIGI TRANSISTOR		
Q903	or UN221E-X	TRANSTSTOR		
Q903	or RT1N44HC-X	DIGI TRANSISTOR		
Q904	DTC144WKA-X	DIGI TRANSISTOR		
Q904	or UN221E-X	TRANSTSTOR		
Q904	or RT1N44HC-X	DIGI TRANSISTOR		
Q905	DTC124XKA-X	DIGI TRANSISTOR		
Q905	or UN221T-X	DIGI TRANSISTOR		
Q905	or RT1N242C-X	DIGI TRANSISTOR		
Q907	2SA1037AK/QR/-X	TRANSISTOR		
Q907	or 2SB709A/QR/-X	TRANSISTOR		
Q907	or 2SA1530A/QR/-X	TRANSISTOR		
Q908	2SA1037AK/QR/-X	TRANSISTOR		
Q908	or 2SB709A/QR/-X	TRANSISTOR		
Q908	or 2SA1530A/QR/-X	TRANSISTOR		
Q912	2SA1037AK/QR/-X	TRANSISTOR		
Q913	2SA1037AK/QR/-X	TRANSISTOR		
Q932	2SA1037AK/QR/-X	TRANSISTOR		
Q932	or 2SB709A/QR/-X	TRANSISTOR		
Q932	or 2SA1530A/QR/-X	TRANSISTOR		
Q933	2SA1037AK/QR/-X	TRANSISTOR		
Q933	or 2SB709A/QR/-X	TRANSISTOR		
Q933	or 2SA1530A/QR/-X	TRANSISTOR		
Q936	2SA1037AK/QR/-X	TRANSISTOR		
Q936	or 2SB709A/QR/-X	TRANSISTOR		
Q936	or 2SA1530A/QR/-X	TRANSISTOR		
Q941	2SA1037AK/QR/-X	TRANSISTOR		
Q942	DTC114TKA-X	TRANSISTOR		
Q943	DTC144WKA-X	DIGI TRANSISTOR		

△ Symbol No.	Part No.	Part Name	Description	Local	△ Symbol No.	Part No.	Part Name	Description	Local
Q943	or UN221E-X	TRANSTSTOR			R913	NRSA63J-0R0X	MG RESISTOR	0Ω 1/16W J	
Q943	or RT1N44HC-X	DIGI TRANSISTOR			R914	NRSA63J-101X	MG RESISTOR	100Ω 1/16W J	
Q944	DTC114EKA-X	DIGI TRANSISTOR			R915	NRSA63J-101X	MG RESISTOR	100Ω 1/16W J	
Q944	or UN2211-X	TRANSISTOR			R916	QRE141J-331Y	C RESISTOR	330Ω 1/4W J	
Q944	or RT1N141C-X	DIGI TRANSISTOR			R917	QRE141J-331Y	C RESISTOR	330Ω 1/4W J	
D904	MTZJ9.1B-T2	Z DIODE			R918	NRSA63J-102X	MG RESISTOR	1kΩ 1/16W J	
C901	QEKJ0JM-227Z	E CAPACITOR	220uF 6.3V M		R919	QRE141J-101Y	C RESISTOR	100Ω 1/4W J	
C902	NDC31HJ-331X	C CAPACITOR	330pF 50V J		R920	NRSA63J-0R0X	MG RESISTOR	0Ω 1/16W J	
C903	NDC31HJ-331X	C CAPACITOR	330pF 50V J		R921	NRSA63J-102X	MG RESISTOR	1kΩ 1/16W J	
C904	NDC31HJ-331X	C CAPACITOR	330pF 50V J		R922	NRSA63J-750X	MG RESISTOR	75Ω 1/16W J	
C905	NDC31HJ-331X	C CAPACITOR	330pF 50V J		R923	NRSA63J-750X	MG RESISTOR	75Ω 1/16W J	
C906	NCB31HK-471X	C CAPACITOR	470pF 50V K		R924	NRSA63D-680X	MG RESISTOR	68Ω 1/16W D	
C907	NCB31HK-471X	C CAPACITOR	470pF 50V K		R925	NRSA63D-750X	MG RESISTOR	75Ω 1/16W D	
C908	NCB31HK-471X	C CAPACITOR	470pF 50V K		R926	NRSA63D-750X	MG RESISTOR	75Ω 1/16W D	
C909	NCB31HK-471X	C CAPACITOR	470pF 50V K		R927	NRSA63J-101X	MG RESISTOR	100Ω 1/16W J	
C914	QEKJ0JM-227Z	E CAPACITOR	220uF 6.3V M		R928	NRSA63J-101X	MG RESISTOR	100Ω 1/16W J	
C915	QEKJ0JM-337Z	E CAPACITOR	330uF 6.3V M		R929	QRE141J-101Y	C RESISTOR	100Ω 1/4W J	
C916	QEKJ0JM-337Z	E CAPACITOR	330uF 6.3V M		R930	QRE141J-101Y	C RESISTOR	100Ω 1/4W J	
C917	QEKJ0JM-337Z	E CAPACITOR	330uF 6.3V M		R931	QRE141J-101Y	C RESISTOR	100Ω 1/4W J	
C918	NDC31HJ-331X	C CAPACITOR	330pF 50V J		R932	QRE141J-101Y	C RESISTOR	100Ω 1/4W J	
C919	NDC31HJ-331X	C CAPACITOR	330pF 50V J		R937	QRE141J-101Y	C RESISTOR	100Ω 1/4W J	
C920	NDC31HJ-331X	C CAPACITOR	330pF 50V J		R939	QRE141J-101Y	C RESISTOR	100Ω 1/4W J	
C921	NDC31HJ-331X	C CAPACITOR	330pF 50V J		R940	NRSA63J-101X	MG RESISTOR	100Ω 1/16W J	
C922	NCB31HK-471X	C CAPACITOR	470pF 50V K		R943	NRSA63J-0R0X	MG RESISTOR	0Ω 1/16W J	
C923	NCB31HK-471X	C CAPACITOR	470pF 50V K		R944	QRE121J-331Y	C RESISTOR	330Ω 1/2W J	
C924	NCB31HK-471X	C CAPACITOR	470pF 50V K		R945	QRE121J-331Y	C RESISTOR	330Ω 1/2W J	
C925	NCB31HK-471X	C CAPACITOR	470pF 50V K		R946	NRSA63J-0R0X	MG RESISTOR	0Ω 1/16W J	
C930	NCB31HK-103X	C CAPACITOR	0.01uF 50V K		R947	NRSA63J-0R0X	MG RESISTOR	0Ω 1/16W J	
C932	NCF31EZ-104X	C CAPACITOR	0.1uF 25V Z		R965	QRE121J-331Y	C RESISTOR	330Ω 1/2W J	
C934	NCB31HK-103X	C CAPACITOR	0.01uF 50V K		R966	NRSA63J-562X	MG RESISTOR	5.6kΩ 1/16W J	
C935	NCB31HK-103X	C CAPACITOR	0.01uF 50V K		R967	NRSA63J-562X	MG RESISTOR	5.6kΩ 1/16W J	
C937	QEKJ1EM-106Z	E CAPACITOR	10uF 25V M		R968	NRSA63J-332X	MG RESISTOR	3.3kΩ 1/16W J	
C939	NCF31AZ-105X	C CAPACITOR	1uF 10V Z		R969	QRE141J-101Y	C RESISTOR	100Ω 1/4W J	
C940	NCF31AZ-105X	C CAPACITOR	1uF 10V Z		R976	QRE141J-102Y	C RESISTOR	1kΩ 1/4W J	
C941	NCF31AZ-105X	C CAPACITOR	1uF 10V Z		R977	QRE141J-823Y	C RESISTOR	82kΩ 1/4W J	
C942	QEKJ1HM-475Z	E CAPACITOR	4.7uF 50V M		R978	NRSA63J-683X	MG RESISTOR	68kΩ 1/16W J	
C944	QEKJ1CM-476Z	E CAPACITOR	47uF 16V M		R985	NRSA63D-750X	MG RESISTOR	75Ω 1/16W D	
C950	QEKJ1EM-106Z	E CAPACITOR	10uF 25V M		R986	NRSA63D-750X	MG RESISTOR	75Ω 1/16W D	
C951	QEKJ1EM-106Z	E CAPACITOR	10uF 25V M		R987	NRSA63D-750X	MG RESISTOR	75Ω 1/16W D	
C952	QEKJ1EM-106Z	E CAPACITOR	10uF 25V M		R988	NRSA63J-101X	MG RESISTOR	100Ω 1/16W J	
C953	NCF31AZ-105X	C CAPACITOR	1uF 10V Z		R989	NRSA63J-101X	MG RESISTOR	100Ω 1/16W J	
C954	NCF31AZ-105X	C CAPACITOR	1uF 10V Z		R990	NRSA63J-273X	MG RESISTOR	27kΩ 1/16W J	
C955	NCF31AZ-105X	C CAPACITOR	1uF 10V Z		R991	NRSA63J-473X	MG RESISTOR	47kΩ 1/16W J	
C956	QEKJ0JM-476Z	E CAPACITOR	47uF 6.3V M		R992	NRSA63J-102X	MG RESISTOR	1kΩ 1/16W J	
C960	NCB31HK-103X	C CAPACITOR	0.01uF 50V K		R993	NRSA63J-393X	MG RESISTOR	39kΩ 1/16W J	
C961	QEKJ0JM-476Z	E CAPACITOR	47uF 6.3V M		R994	NRSA63J-103X	MG RESISTOR	10kΩ 1/16W J	
C962	NCB31HK-103X	C CAPACITOR	0.01uF 50V K		L903	QQL071J-1R0Y	COIL	1uH J	
C963	QEKJ1CM-476Z	E CAPACITOR	47uF 16V M		L904	QQL071J-4R7Y	COIL	4.7uH J	
C964	NCB31HK-103X	C CAPACITOR	0.01uF 50V K		L905	QQL071J-4R7Y	COIL	4.7uH J	
C965	NCB31HK-103X	C CAPACITOR	0.01uF 50V K		L908	QQL231J-R22Y	COIL	0.22uH J	
C968	NCF31AZ-105X	C CAPACITOR	1uF 10V Z		L909	QQL071J-4R7Y	COIL	4.7uH J	
C971	QEKJ1CM-476Z	E CAPACITOR	47uF 16V M		L910	QQL071J-4R7Y	COIL	4.7uH J	
C973	NCB31HK-103X	C CAPACITOR	0.01uF 50V K		L917	QQL29BJ-100Z	P COIL	10uH J	
C981	QEKJ0JM-227Z	E CAPACITOR	220uF 6.3V M		L918	QQL29BJ-100Z	P COIL	10uH J	
C982	QEKJ0JM-337Z	E CAPACITOR	330uF 6.3V M		L919	QQL29BJ-100Z	P COIL	10uH J	
C983	QEKJ0JM-337Z	E CAPACITOR	330uF 6.3V M		L931	QQL071J-100Y	COIL	10uH J	
C986	NCB31HK-102X	C CAPACITOR	1000pF 50V K		L932	QQL071J-100Y	COIL	10uH J	
C988	NCB31HK-102X	C CAPACITOR	1000pF 50V K		L933	QQL071J-100Y	COIL	10uH J	
C991	QEKJ0JM-227Z	E CAPACITOR	220uF 6.3V M		L934	QQL071J-100Y	COIL	10uH J	
C992	QEKJ0JM-227Z	E CAPACITOR	220uF 6.3V M		CN913	QGB2024J1-15S	CONNECTOR	B-B (1-15)	
C994	QEKJ0JM-227Z	E CAPACITOR	220uF 6.3V M		CN914	QGB2024J1-13S	CONNECTOR	B-B (1-13)	
C996	NCB31HK-103X	C CAPACITOR	0.01uF 50V K		CN915	QGB2024J1-17S	CONNECTOR	B-B (1-17)	
C997	NCB31HK-103X	C CAPACITOR	0.01uF 50V K		ET1	QNZ0431-001Z	EARTH TERMINAL		
R901	NRSA63J-103X	MG RESISTOR	10kΩ 1/16W J		J901	QNZ0627-001	21P CONNECTOR	L-1 IN/OUT	
R902	NRSA63J-273X	MG RESISTOR	27kΩ 1/16W J		J902	QNZ0627-001	21P CONNECTOR	L-2 IN/DECODER	
R903	NRSA63J-183X	MG RESISTOR	18kΩ 1/16W J		J905	QNN0599-002	PIN JACK	COMPONENT	
R904	NRSA63J-474X	MG RESISTOR	470kΩ 1/16W J		J907	QNN0295-002	PIN JACK	AUDIO	
R905	NRSA63J-103X	MG RESISTOR	10kΩ 1/16W J		W101	NRSA63J-0R0X	MG RESISTOR	0Ω 1/16W J	
R906	NRSA63J-151X	MG RESISTOR	150Ω 1/16W J		W102	NRSA63J-0R0X	MG RESISTOR	0Ω 1/16W J	
R907	NRSA63J-151X	MG RESISTOR	150Ω 1/16W J		W103	NRSA63J-0R0X	MG RESISTOR	0Ω 1/16W J	
R908	NRSA63J-151X	MG RESISTOR	150Ω 1/16W J		W104	NRSA63J-0R0X	MG RESISTOR	0Ω 1/16W J	
R909	NRSA63J-750X	MG RESISTOR	75Ω 1/16W J		W105	NRSA63J-0R0X	MG RESISTOR	0Ω 1/16W J	
R910	NRSA63J-750X	MG RESISTOR	75Ω 1/16W J		W106	NRSA63J-0R0X	MG RESISTOR	0Ω 1/16W J	
R911	NRSA63J-0R0X	MG RESISTOR	0Ω 1/16W J		W107	NRSA63J-0R0X	MG RESISTOR	0Ω 1/16W J	
R912	NRSA63J-0R0X	MG RESISTOR	0Ω 1/16W J						



## DC/DC Converter board

### Block No. [1][1]

△ Symbol No.	Part No.	Part Name	Description	Local
PW1	LPA20041-02B	DC/DC CONVERTER BOARD ASSY		
IC5701	BD9851EFV-X	IC		
IC5710	QS5U27-W	MOS FET		
Q5720	RTQ035P02-W	MOS FET		
D5710	RB520S-30-X	SB DIODE		
D5720	RB520S-30-X	SB DIODE		
D5721	SX34-X	SB DIODE		
D5721	or RB051L-40-X	SB DIODE		
C5710	NCB31HK-681X	C CAPACITOR	680pF 50V K	
C5711	NCB30JK-105X	C CAPACITOR	1uF 6.3V K	
C5712	NCB31CK-104X	C CAPACITOR	0.1uF 16V K	
C5713	NCF31AZ-105X	C CAPACITOR	1uF 10V Z	
C5714	NCB10JK-106X	C CAPACITOR	10uF 6.3V K	
C5716	NDC31HJ-151X	C CAPACITOR	150pF 50V J	
C5720	NCB31HK-681X	C CAPACITOR	680pF 50V K	
C5721	NCB30JK-105X	C CAPACITOR	1uF 6.3V K	
C5722	NCB31CK-104X	C CAPACITOR	0.1uF 16V K	
C5723	NCF31AZ-105X	C CAPACITOR	1uF 10V Z	
C5724	NCB10JK-106X	C CAPACITOR	10uF 6.3V K	
C5726	NCB31HK-331X	C CAPACITOR	330pF 50V K	
C5727	NCB31CK-104X	C CAPACITOR	0.1uF 16V K	
C5730	NCF31AZ-105X	C CAPACITOR	1uF 10V Z	
C5731	NDC31HJ-101X	C CAPACITOR	100pF 50V J	
C5732	NCB31CK-223X	C CAPACITOR	0.022uF 16V K	
R5710	NRSA63J-153X	MG RESISTOR	15kΩ 1/16W J	
R5711	NRSA63J-474X	MG RESISTOR	470kΩ 1/16W J	
R5712	NRSA63J-0R0X	MG RESISTOR	0Ω 1/16W J	
R5713	NRSA63J-222X	MG RESISTOR	2.2kΩ 1/16W J	
R5720	NRSA63J-153X	MG RESISTOR	15kΩ 1/16W J	
R5721	NRSA63J-474X	MG RESISTOR	470kΩ 1/16W J	
R5722	NRSA63J-0R0X	MG RESISTOR	0Ω 1/16W J	
R5723	NRSA63J-102X	MG RESISTOR	1kΩ 1/16W J	
R5730	NRSA63J-103X	MG RESISTOR	10kΩ 1/16W J	
R5731	NRSA63J-153X	MG RESISTOR	15kΩ 1/16W J	
R5732	NRSA63J-103X	MG RESISTOR	10kΩ 1/16W J	
L5710	NQL82EN-100X	COIL	10uH N	
L5720	NQR0562-001X	CHOKE COIL		
CN5701	QGG2009M1-13	CONNECTOR	(1-13)	
CN5702	QGG2009M1-03	CONNECTOR	(1-3)	
K5710	NQR0499-002X	FERRITE BEADS		
K5720	NQR0499-002X	FERRITE BEADS		

## A/C Head board

### Block No. [1][2]

△ Symbol No.	Part No.	Part Name	Description	Local
PW1	LPA10158-01A1	A/C HEAD BOARD ASSY		

## Demodulator board

### Block No. [1][4]

△ Symbol No.	Part No.	Part Name	Description	Local
PW1	LPA10292-04A	DEMODULATOR BOARD ASSY		
PW1	LPA10292-03A	DEMODULATOR BOARD ASSY		

△ Symbol No. Part No. Part Name Description Local

IC6701	MSP3417GQGB8V3X	IC		
D6701	1SS133-T2	SI DIODE		
D6701	or 1SS270A-T2	SI DIODE		
C6704	NCB31HK-103X	C CAPACITOR	0.01uF 50V K	EF
C6704	NCB30JK-105X	C CAPACITOR	1uF 6.3V K	E,EK
C6707	NDC31HJ-470X	C CAPACITOR	47pF 50V J	
C6708	NDC31HJ-8R0X	C CAPACITOR	8pF 50V J	
C6709	NDC31HJ-150X	C CAPACITOR	15pF 50V J	EF
C6709	NDC31HJ-8R0X	C CAPACITOR	8pF 50V J	E,EK
C6713	NCB30JK-105X	C CAPACITOR	1uF 6.3V K	
C6714	NCB31HK-222X	C CAPACITOR	2200pF 50V K	
C6715	QEKJ1HM-225Z	E CAPACITOR	2.2uF 50V M	
C6716	NCB31HK-222X	C CAPACITOR	2200pF 50V K	
C6717	QEKJ1HM-225Z	E CAPACITOR	2.2uF 50V M	
C6719	QEKJ1EM-106Z	E CAPACITOR	10uF 25V M	
C6720	QEKJ1EM-106Z	E CAPACITOR	10uF 25V M	
C6721	NCB31HK-103X	C CAPACITOR	0.01uF 50V K	
C6723	NCB31HK-103X	C CAPACITOR	0.01uF 50V K	
C6724	QEKJ1HM-225Z	E CAPACITOR	2.2uF 50V M	EF
R6707	NRSA63J-330X	MG RESISTOR	33Ω 1/16W J	
R6708	NRSA63J-103X	MG RESISTOR	10kΩ 1/16W J	
R6709	NRSA63J-102X	MG RESISTOR	1kΩ 1/16W J	
R6710	NRSA63J-0R0X	MG RESISTOR	0Ω 1/16W J	
R6711	NRSA63J-104X	MG RESISTOR	100kΩ 1/16W J	
R6712	NRSA63J-102X	MG RESISTOR	1kΩ 1/16W J	
R6713	NRSA63J-123X	MG RESISTOR	12kΩ 1/16W J	
R6714	NRSA63J-102X	MG RESISTOR	1kΩ 1/16W J	
R6715	NRSA63J-123X	MG RESISTOR	12kΩ 1/16W J	
R6716	NRSA63J-470X	MG RESISTOR	47Ω 1/16W J	
R6719	QRE141J-103Y	C RESISTOR	10kΩ 1/4W J	
R6720	NRSA63J-562X	MG RESISTOR	5.6kΩ 1/16W J	
R6721	NRSA63J-562X	MG RESISTOR	5.6kΩ 1/16W J	
B6701	NRSA63J-0R0X	MG RESISTOR	0Ω 1/16W J	
CN6701	QGG2502K1-10	CONNECTOR	(1-10)	
K6701	NQR0129-003X	FERRITE BEADS		
K6702	NQR0129-003X	FERRITE BEADS		
K6705	NQR0129-003X	FERRITE BEADS		
K6706	NQR0129-003X	FERRITE BEADS		
K6707	NQR0129-003X	FERRITE BEADS		EF
K6708	NRSA63J-0R0X	MG RESISTOR	0Ω 1/16W J	
W6701	NRSA63J-0R0X	MG RESISTOR	0Ω 1/16W J	
X6701	QAX0773-001Z	CRYSTAL	18.432000MHz	
OT1	LP40425-001A	BRACKET(PWB)		

## Operation/jack board

### Block No. [2][7]

△ Symbol No. Part No. Part Name Description Local

PW1	LPA10298-03B5	OPERATON JACK BOARD ASSY		
C7202	NDC31HJ-102X	C CAPACITOR	1000pF 50V J	
C7204	NDC31HJ-102X	C CAPACITOR	1000pF 50V J	
C7206	NCB31HK-103X	C CAPACITOR	0.01uF 50V K	
R7202	QRE141J-750Y	C RESISTOR	75Ω 1/4W J	
R7206	NRSA63J-750X	MG RESISTOR	75Ω 1/16W J	
R7207	NRSA63J-750X	MG RESISTOR	75Ω 1/16W J	
L7202	QRE141J-101Y	C RESISTOR	100Ω 1/4W J	
L7203	QRE141J-101Y	C RESISTOR	100Ω 1/4W J	
CN7201	QGF1208C1-09	CONNECTOR	FFC/FPC (1-9)	
CN7202	QGD2503C1-04	CONNECTOR	(1-4)	
J7201	QNN0591-001	PIN JACK	FRONT AV	
J7204	QND0084-001	S JACK	FRONT S	
S7216	QSW0381-001Z	TACT SWITCH	VHS_EJECT	
S7218	QSW0381-001Z	TACT SWITCH	OPE	

# Switch/Display board

Block No. [2][8]

△ Symbol No.	Part No.	Part Name	Description	Local
PW1	LPA10298-03B4	DISPLAY/SWITCH BOARD ASSY		
IC7001	PT6315	IC		
IC7002	GP1UM281XKVF	IR DETECT UNIT		
IC7002	or PNA4652M00XB	IR DETECT UNIT 38kHz		
Q7001	UN221L-X	DIGI TRANSISTOR		
Q7001	or DTC143EKA-X	DIGI TRANSISTOR		
Q7001	or RT1N431C-X	DIGI TRANSISTOR		
Q7002	UN221L-X	DIGI TRANSISTOR		
Q7002	or DTC143EKA-X	DIGI TRANSISTOR		
Q7002	or RT1N431C-X	DIGI TRANSISTOR		
Q7003	UN221L-X	DIGI TRANSISTOR		
Q7003	or DTC143EKA-X	DIGI TRANSISTOR		
Q7003	or RT1N431C-X	DIGI TRANSISTOR		
D7001	1SS133-T2	SI DIODE		
D7001	or 1SS270A-T2	SI DIODE		
D7002	1SS133-T2	SI DIODE		
D7002	or 1SS270A-T2	SI DIODE		
D7003	1SS133-T2	SI DIODE		
D7003	or 1SS270A-T2	SI DIODE		
D7004	1SS133-T2	SI DIODE		
D7004	or 1SS270A-T2	SI DIODE		
D7005	1SS133-T2	SI DIODE		
D7005	or 1SS270A-T2	SI DIODE		
D7012	1SS133-T2	SI DIODE		
D7012	or 1SS270A-T2	SI DIODE		
D7013	1SS133-T2	SI DIODE		
D7013	or 1SS270A-T2	SI DIODE		
D7014	1SS133-T2	SI DIODE		
D7014	or 1SS270A-T2	SI DIODE		
D7015	1SS133-T2	SI DIODE		
D7015	or 1SS270A-T2	SI DIODE		
D7016	1SS133-T2	SI DIODE		
D7016	or 1SS270A-T2	SI DIODE		
D7021	MTZJ9.1B-T2	Z DIODE		
D7041	SLR343WBCT3	LED	VHS	
D7042	SLR-343VC-T	LED	VHS REC	
D7043	SLR-343VC-T	LED	HDD REC	
D7044	SLR-343VC-T	LED	DVD REC	
D7045	SDPB50A0/DEGH/LED	LED	BLUE LIGHT	
D7045	or SLA-580BC3T3F	LED	BLUE LIGHT	
D7046	SLR343WBCT3	LED	HDD	
D7047	SLR343WBCT3	LED	DVD	
D7048	SDPB50A0/DEGH/LED	LED	BLUE LIGHT	
D7048	or SLA-580BC3T3F	LED	BLUE LIGHT	
C7001	NCB31EK-104X	C CAPACITOR	0.1uF 25V K	
C7002	QCFB1HZ-104Y	C CAPACITOR	0.1uF 50V Z	
C7003	QEKJ1HM-106Z	E CAPACITOR	10uF 50V M	
C7006	QEKCOJM-227Z	E CAPACITOR	220uF 6.3V M	
C7007	QCFB1HZ-104Y	C CAPACITOR	0.1uF 50V Z	
C7008	QERF1AM-227Z	E CAPACITOR	220uF 10V M	
C7010	NCF31HZ-473X	C CAPACITOR	0.047uF 50V Z	
C7011	NCF31HZ-473X	C CAPACITOR	0.047uF 50V Z	
R7001	QRE141J-103Y	C RESISTOR	10kΩ 1/4W J	
R7002	QRE141J-103Y	C RESISTOR	10kΩ 1/4W J	
R7003	QRE141J-823Y	C RESISTOR	82kΩ 1/4W J	
R7005	QRE141J-472Y	C RESISTOR	4.7kΩ 1/4W J	
R7006	NRSA63J-472X	MG RESISTOR	4.7kΩ 1/16W J	
R7007	NRSA63J-102X	MG RESISTOR	1kΩ 1/16W J	
R7009	QRE141J-103Y	C RESISTOR	10kΩ 1/4W J	
R7010	NRSA63J-103X	MG RESISTOR	10kΩ 1/16W J	
R7013	QRE141J-333Y	C RESISTOR	33kΩ 1/4W J	
R7014	QRE141J-333Y	C RESISTOR	33kΩ 1/4W J	
R7015	NRSA63J-102X	MG RESISTOR	1kΩ 1/16W J	
R7022	QRE141J-102Y	C RESISTOR	1kΩ 1/4W J	
R7035	NRSA63J-0R0X	MG RESISTOR	0Ω 1/16W J	
R7041	QRE141J-331Y	C RESISTOR	330Ω 1/4W J	
R7042	QRE141J-181Y	C RESISTOR	180Ω 1/4W J	
R7043	QRE141J-181Y	C RESISTOR	180Ω 1/4W J	
R7044	NRSA63J-181X	MG RESISTOR	180Ω 1/16W J	

△ Symbol No.	Part No.	Part Name	Description	Local
R7045	NRSA63J-101X	MG RESISTOR	100Ω 1/16W J	
R7046	QRE141J-331Y	C RESISTOR	330Ω 1/4W J	
R7047	NRSA63J-331X	MG RESISTOR	330Ω 1/16W J	
R7048	QRE141J-101Y	C RESISTOR	100Ω 1/4W J	
CN7001	QGF1209F2-15	CONNECTOR	FFC/FPC (1-15)	
DI7001	QLF0143-001	FL TUBE		
FW7001	QUM024-07A4BF-E	PARA RIBON WIRE		
HD1	PQ34949-1-1	FL HOLDER(L)	FOR DI7001	
HD2	PQ34950-1-1	FDP HOLDER(R)	FOR DI7001	
S7002	QSW0381-001Z	TACT SWITCH	CH+	
S7004	QSW0381-001Z	TACT SWITCH	DOWN	
S7012	QSW0381-001Z	TACT SWITCH	VHS/HD/DVD	
S7013	QSW0381-001Z	TACT SWITCH	RIGHT	
S7014	QSW0381-001Z	TACT SWITCH	PAUSE	
S7015	QSW0381-001Z	TACT SWITCH	STOP	
S7022	QSW0381-001Z	TACT SWITCH	CH-	
S7023	QSW0381-001Z	TACT SWITCH	UP	
S7024	QSW0381-001Z	TACT SWITCH	GUIDE	
S7032	QSW0381-001Z	TACT SWITCH	OPEN/CLOSE	
S7033	QSW0381-001Z	TACT SWITCH	LEFT	
S7034	QSW0381-001Z	TACT SWITCH	REC	
S7035	QSW0381-001Z	TACT SWITCH	PLAY	
S7036	QSW0381-001Z	TACT SWITCH	NAVI	
S7037	QSW0381-001Z	TACT SWITCH	DUB	
S7038	QSW0381-001Z	TACT SWITCH	SET	
W41	NRSA63J-0R0X	MG RESISTOR	0Ω 1/16W J	
W42	NRSA63J-0R0X	MG RESISTOR	0Ω 1/16W J	
W43	NRSA63J-0R0X	MG RESISTOR	0Ω 1/16W J	
W44	NRSA63J-0R0X	MG RESISTOR	0Ω 1/16W J	
W45	NRSA63J-0R0X	MG RESISTOR	0Ω 1/16W J	

# DV Jack board

Block No. [3][6]

△ Symbol No.	Part No.	Part Name	Description	Local
PW1	LPA10298-03A3	DV JACK BOARD ASSY		
CN4104	QGB1231M1-09	CONNECTOR	B-B (1-9)	
GN4101	QNZ0136-001Z	EARTH PLATE		
J4112	QNZ0675-001	D CONNECTOR	F-DV	

# Digital board

Block No. [5][0]

△ Symbol No.	Part No.	Part Name	Description	Local
PW1	LPA10300-05C	DIGITAL BOARD ASSY		
IC1001	JCP8059-2	IC		
IC1002	HY57V161610ETP7	IC		
IC1002	or K4S161622H-UC60	IC		
IC1201	LPN0986-001A	IC(FLASH)	(SERVICE)	
IC1202	SN74LVC373APW-X	IC(DIGITAL)		
IC1203	SN74LVC373APW-X	IC(DIGITAL)		
IC1401	DMN8652-B0L	IC(DIGITAL)		
IC1404	SN74HCT08APW-X	IC		
IC1601	HY5DU561622DT-J	IC		
IC1602	HY5DU561622DT-J	IC		
IC1603	HY5DU561622DT-J	IC		
IC1604	HY5DU561622DT-J	IC		
IC1701	BD3533F-X	IC		
IC1801	TSB41AB1PAP	IC		
IC1901	TVP5150AM1PBS-W	IC		

△ Symbol No.	Part No.	Part Name	Description	Local	△ Symbol No.	Part No.	Part Name	Description	Local
Q1001	2SA1530A/QR/-X	TRANSISTOR			C1093	NCB31CK-104X	C CAPACITOR	0.1uF 16V K	
Q1001	or 2SA1037AK/QR/-X	TRANSISTOR			C1094	NCB31CK-104X	C CAPACITOR	0.1uF 16V K	
Q1001	or 2SB709A/QR/-X	TRANSISTOR			C1095	NBE20JM-106X	TA E CAPACITOR	10uF 6.3V M	
Q1002	2SA1530A/QR/-X	TRANSISTOR			C1097	NCB31CK-104X	C CAPACITOR	0.1uF 16V K	
Q1002	or 2SA1037AK/QR/-X	TRANSISTOR			C1098	NCB31CK-104X	C CAPACITOR	0.1uF 16V K	
Q1002	or 2SB709A/QR/-X	TRANSISTOR			C1203	NCB31CK-104X	C CAPACITOR	0.1uF 16V K	
Q1003	2SA1530A/QR/-X	TRANSISTOR			C1204	NBE20JM-226X	TA E CAPACITOR	22uF 6.3V M	
Q1003	or 2SA1037AK/QR/-X	TRANSISTOR			C1206	NCB31CK-104X	C CAPACITOR	0.1uF 16V K	
Q1003	or 2SB709A/QR/-X	TRANSISTOR			C1207	NCB31CK-104X	C CAPACITOR	0.1uF 16V K	
Q1006	2SA1530A/QR/-X	TRANSISTOR			C1301	NBE20JM-226X	TA E CAPACITOR	22uF 6.3V M	
Q1006	or 2SA1037AK/QR/-X	TRANSISTOR			C1302	NCB31CK-104X	C CAPACITOR	0.1uF 16V K	
Q1006	or 2SB709A/QR/-X	TRANSISTOR			C1307	NBE20JM-106X	TA E CAPACITOR	10uF 6.3V M	
Q1008	BC847PN-X	PAIR TRANSISTOR			C1310	NCB31AK-224X	C CAPACITOR	0.22uF 10V K	
Q1008	or UMZ1N-W	PAIR TRANSISTOR			C1315	NDC31HJ-120X	C CAPACITOR	12pF 50V J	
Q1008	or BC846PN-X	PAIR TRANSISTOR			C1316	NDC31HJ-120X	C CAPACITOR	12pF 50V J	
Q1009	2SC3928A/QRS/-X	TRANSISTOR			C1323	NRSA63J-0R0X	MG RESISTOR	0Ω 1/16W J	
Q1009	or 2SC2412K/QRS/-X	TRANSISTOR			C1401	NCB31CK-104X	C CAPACITOR	0.1uF 16V K	
Q1009	or 2SD601A/QRS/-X	TRANSISTOR			C1403	NCB31CK-104X	C CAPACITOR	0.1uF 16V K	
Q1010	2SC3928A/QRS/-X	TRANSISTOR			C1404	NEHM0JM-107X	E CAPACITOR	100uF 6.3V M	
Q1010	or 2SC2412K/QRS/-X	TRANSISTOR			C1408	NCB31CK-104X	C CAPACITOR	0.1uF 16V K	
Q1010	or 2SD601A/QRS/-X	TRANSISTOR			C1411	NEHM0JM-107X	E CAPACITOR	100uF 6.3V M	
Q1011	2SC3928A/QRS/-X	TRANSISTOR			C1412	NCB31CK-104X	C CAPACITOR	0.1uF 16V K	
Q1011	or 2SC2412K/QRS/-X	TRANSISTOR			C1413	NEHM0JM-107X	E CAPACITOR	100uF 6.3V M	
Q1011	or 2SD601A/QRS/-X	TRANSISTOR			C1414	NCB31CK-104X	C CAPACITOR	0.1uF 16V K	
Q1301	2SA1037AK/QR/-X	TRANSISTOR			C1415	NCB31CK-104X	C CAPACITOR	0.1uF 16V K	
Q1301	or 2SA1530A/QR/-X	TRANSISTOR			C1417	NCB31CK-104X	C CAPACITOR	0.1uF 16V K	
Q1301	or 2SB709A/QR/-X	TRANSISTOR			C1420	NBE20JM-106X	TA E CAPACITOR	10uF 6.3V M	
Q1304	2SC2412K/QRS/-X	TRANSISTOR			C1421	NCB31CK-104X	C CAPACITOR	0.1uF 16V K	
Q1304	or 2SC3928A/QRS/-X	TRANSISTOR			C1422	NCB31CK-104X	C CAPACITOR	0.1uF 16V K	
Q1304	or 2SD601A/QRS/-X	TRANSISTOR			C1424	NCB31CK-104X	C CAPACITOR	0.1uF 16V K	
					C1427	NBE20JM-106X	TA E CAPACITOR	10uF 6.3V M	
D1001	1SS355-X	SI DIODE			C1428	NCB31CK-104X	C CAPACITOR	0.1uF 16V K	
D1001	or MA111-X	SI DIODE			C1429	NCB31CK-104X	C CAPACITOR	0.1uF 16V K	
D1401	1SS355-X	SI DIODE			C1430	NCB31CK-104X	C CAPACITOR	0.1uF 16V K	
D1401	or MA111-X	SI DIODE			C1435	NBE20JM-106X	TA E CAPACITOR	10uF 6.3V M	
D1402	1SS355-X	SI DIODE			C1436	NCB31CK-104X	C CAPACITOR	0.1uF 16V K	
D1402	or MA111-X	SI DIODE			C1438	NCB31CK-104X	C CAPACITOR	0.1uF 16V K	
D1403	1SS355-X	SI DIODE			C1439	NCB31CK-104X	C CAPACITOR	0.1uF 16V K	
D1403	or MA111-X	SI DIODE			C1444	NCB31CK-104X	C CAPACITOR	0.1uF 16V K	
D2101	SML-010LT-X	LED			C1445	NCB31CK-104X	C CAPACITOR	0.1uF 16V K	
D2101	or SML-010MT-X	LED			C1446	NCB31CK-104X	C CAPACITOR	0.1uF 16V K	
D2201	SML-010LT-X	LED			C1447	NCB31CK-104X	C CAPACITOR	0.1uF 16V K	
D2201	or SML-010MT-X	LED			C1448	NCB31EK-103X	C CAPACITOR	0.01uF 25V K	
					C1452	NCB31CK-104X	C CAPACITOR	0.1uF 16V K	
C1001	NBE20JM-226X	TA E CAPACITOR	22uF 6.3V M		C1453	NCB31CK-104X	C CAPACITOR	0.1uF 16V K	
C1002	NBE20JM-106X	TA E CAPACITOR	10uF 6.3V M		C1454	NCB31CK-104X	C CAPACITOR	0.1uF 16V K	
C1003	NCB31CK-104X	C CAPACITOR	0.1uF 16V K		C1455	NCB31CK-104X	C CAPACITOR	0.1uF 16V K	
C1005	NCB31CK-104X	C CAPACITOR	0.1uF 16V K		C1457	NCB31CK-104X	C CAPACITOR	0.1uF 16V K	
C1007	NCB31CK-104X	C CAPACITOR	0.1uF 16V K		C1459	NCB31CK-104X	C CAPACITOR	0.1uF 16V K	
C1009	NCB31CK-104X	C CAPACITOR	0.1uF 16V K		C1460	NDC31HJ-120X	C CAPACITOR	12pF 50V J	
C1010	NRSA63J-0R0X	MG RESISTOR	0Ω 1/16W J		C1461	NDC31HJ-120X	C CAPACITOR	12pF 50V J	
C1012	NCB31CK-104X	C CAPACITOR	0.1uF 16V K		C1462	NCB31HK-104X	C CAPACITOR	0.1uF 50V K	
C1014	NCB31CK-104X	C CAPACITOR	0.1uF 16V K		C1464	NCB31CK-104X	C CAPACITOR	0.1uF 16V K	
C1015	NCB31CK-104X	C CAPACITOR	0.1uF 16V K		C1466	NCB31CK-104X	C CAPACITOR	0.1uF 16V K	
C1018	NCB31CK-104X	C CAPACITOR	0.1uF 16V K		C1467	NCB31CK-104X	C CAPACITOR	0.1uF 16V K	
C1019	NCB31EK-103X	C CAPACITOR	0.01uF 25V K		C1470	NCB31CK-104X	C CAPACITOR	0.1uF 16V K	
C1026	NCB31CK-104X	C CAPACITOR	0.1uF 16V K		C1471	NCB31CK-104X	C CAPACITOR	0.1uF 16V K	
C1032	NCB31CK-104X	C CAPACITOR	0.1uF 16V K		C1472	NCB31CK-104X	C CAPACITOR	0.1uF 16V K	
C1033	NCB31CK-104X	C CAPACITOR	0.1uF 16V K		C1473	NCB31CK-104X	C CAPACITOR	0.1uF 16V K	
C1034	NCB31CK-104X	C CAPACITOR	0.1uF 16V K		C1474	NCB31CK-104X	C CAPACITOR	0.1uF 16V K	
C1035	NCB31CK-104X	C CAPACITOR	0.1uF 16V K		C1601	NEX60GM-337X	E CAPACITOR	330uF 4V M	
C1036	NCB31CK-104X	C CAPACITOR	0.1uF 16V K		C1606	NCB31CK-104X	C CAPACITOR	0.1uF 16V K	
C1041	NBE20JM-106X	TA E CAPACITOR	10uF 6.3V M		C1607	NCB31CK-104X	C CAPACITOR	0.1uF 16V K	
C1042	NCB31CK-104X	C CAPACITOR	0.1uF 16V K		C1608	NCB31CK-104X	C CAPACITOR	0.1uF 16V K	
C1043	NCB31CK-104X	C CAPACITOR	0.1uF 16V K		C1609	NCB31CK-104X	C CAPACITOR	0.1uF 16V K	
C1044	NCB31CK-104X	C CAPACITOR	0.1uF 16V K		C1610	NCB31CK-104X	C CAPACITOR	0.1uF 16V K	
C1045	NCB31CK-104X	C CAPACITOR	0.1uF 16V K		C1611	NCB31CK-104X	C CAPACITOR	0.1uF 16V K	
C1046	NCB31CK-104X	C CAPACITOR	0.1uF 16V K		C1612	NCB31CK-104X	C CAPACITOR	0.1uF 16V K	
C1047	NCB31CK-104X	C CAPACITOR	0.1uF 16V K		C1614	NCB31CK-104X	C CAPACITOR	0.1uF 16V K	
C1048	NCB31CK-104X	C CAPACITOR	0.1uF 16V K		C1615	NCB31CK-104X	C CAPACITOR	0.1uF 16V K	
C1049	NCB31CK-104X	C CAPACITOR	0.1uF 16V K		C1616	NCB31CK-104X	C CAPACITOR	0.1uF 16V K	
C1050	NBE20JM-106X	TA E CAPACITOR	10uF 6.3V M		C1617	NCB31CK-104X	C CAPACITOR	0.1uF 16V K	
C1051	NBE20JM-106X	TA E CAPACITOR	10uF 6.3V M		C1618	NCB31CK-104X	C CAPACITOR	0.1uF 16V K	
C1052	NCB31CK-104X	C CAPACITOR	0.1uF 16V K		C1619	NCB31CK-104X	C CAPACITOR	0.1uF 16V K	
C1065	NCB20JM-475X	C CAPACITOR	4.7uF 6.3V M		C1620	NCB31CK-104X	C CAPACITOR	0.1uF 16V K	
C1077	NCB31CK-104X	C CAPACITOR	0.1uF 16V K		C1622	NCB31CK-104X	C CAPACITOR	0.1uF 16V K	
C1088	NCB31CK-104X	C CAPACITOR	0.1uF 16V K		C1623	NCB31CK-104X	C CAPACITOR	0.1uF 16V K	
C1090	NCB31CK-104X	C CAPACITOR	0.1uF 16V K		C1624	NCB31CK-104X	C CAPACITOR	0.1uF 16V K	

△ Symbol No.	Part No.	Part Name	Description	Local	△ Symbol No.	Part No.	Part Name	Description	Local
C1625	NCB31CK-104X	C CAPACITOR	0.1uF 16V K		R1050	NRSA63J-152X	MG RESISTOR	1.5kΩ 1/16W J	
C1626	NCB31CK-104X	C CAPACITOR	0.1uF 16V K		R1051	NRSA63D-181X	MG RESISTOR	180Ω 1/16W D	
C1627	NCB31CK-104X	C CAPACITOR	0.1uF 16V K		R1054	NRSA63D-332X	MG RESISTOR	3.3kΩ 1/16W D	
C1628	NCB31CK-104X	C CAPACITOR	0.1uF 16V K		R1056	NRSA63J-222X	MG RESISTOR	2.2kΩ 1/16W J	
C1630	NCB31CK-104X	C CAPACITOR	0.1uF 16V K		R1057	NRSA63J-330X	MG RESISTOR	33Ω 1/16W J	
C1631	NCB31CK-104X	C CAPACITOR	0.1uF 16V K		R1059	NRSA63J-471X	MG RESISTOR	470Ω 1/16W J	
C1632	NCB31CK-104X	C CAPACITOR	0.1uF 16V K		R1060	NRSA63J-223X	MG RESISTOR	22kΩ 1/16W J	
C1633	NCB31CK-104X	C CAPACITOR	0.1uF 16V K		R1061	NRSA63J-223X	MG RESISTOR	22kΩ 1/16W J	
C1634	NCB31CK-104X	C CAPACITOR	0.1uF 16V K		R1064	NRSA63J-102X	MG RESISTOR	1kΩ 1/16W J	
C1635	NCB31CK-104X	C CAPACITOR	0.1uF 16V K		R1066	NRSA63J-101X	MG RESISTOR	100Ω 1/16W J	
C1636	NCB31CK-104X	C CAPACITOR	0.1uF 16V K		R1067	NRSA63J-620X	MG RESISTOR	62Ω 1/16W J	
C1641	NCB31CK-104X	C CAPACITOR	0.1uF 16V K		R1068	NRSA63D-222X	MG RESISTOR	2.2kΩ 1/16W D	
C1642	NCB31CK-104X	C CAPACITOR	0.1uF 16V K		R1069	NRSA63D-222X	MG RESISTOR	2.2kΩ 1/16W D	
C1643	NCB31CK-104X	C CAPACITOR	0.1uF 16V K		R1070	NRSA63D-122X	MG RESISTOR	1.2kΩ 1/16W D	
C1644	NCB31CK-104X	C CAPACITOR	0.1uF 16V K		R1071	NRSA63D-152X	MG RESISTOR	1.5kΩ 1/16W D	
C1645	NCB31CK-104X	C CAPACITOR	0.1uF 16V K		R1222	NRSA63J-0R0X	MG RESISTOR	0Ω 1/16W J	
C1646	NCB31CK-104X	C CAPACITOR	0.1uF 16V K		R1225	NRSA63J-103X	MG RESISTOR	10kΩ 1/16W J	
C1647	NCB31CK-104X	C CAPACITOR	0.1uF 16V K		R1226	NRSA63J-472X	MG RESISTOR	4.7kΩ 1/16W J	
C1648	NCB31CK-104X	C CAPACITOR	0.1uF 16V K		R1229	NRSA63J-472X	MG RESISTOR	4.7kΩ 1/16W J	
C1649	NCB31CK-104X	C CAPACITOR	0.1uF 16V K		R1230	NRSA63J-472X	MG RESISTOR	4.7kΩ 1/16W J	
C1701	NCB31CK-104X	C CAPACITOR	0.1uF 16V K		R1231	NRSA63J-472X	MG RESISTOR	4.7kΩ 1/16W J	
C1702	NEHM0JM-476X	E CAPACITOR	47uF 6.3V M		R1302	NRSA63J-0R0X	MG RESISTOR	0Ω 1/16W J	
C1704	NCB31CK-104X	C CAPACITOR	0.1uF 16V K		R1303	NRSA63J-821X	MG RESISTOR	820Ω 1/16W J	
C1706	NBE20JM-476X	TA E CAPACITOR	47uF 6.3V M		R1308	NRSA63J-681X	MG RESISTOR	680Ω 1/16W J	
C1707	NCB10JK-106X	C CAPACITOR	10uF 6.3V K		R1401	NRSA63F-1181X	MG RESISTOR	1.18kΩ 1/16W F	
C1708	NCB31CK-104X	C CAPACITOR	0.1uF 16V K		R1402	NRSA63J-0R0X	MG RESISTOR	0Ω 1/16W J	
C1709	NBE20JM-106X	TA E CAPACITOR	10uF 6.3V M		R1404	NRSA63J-101X	MG RESISTOR	100Ω 1/16W J	
C1710	NCB31CK-104X	C CAPACITOR	0.1uF 16V K		R1405	NRSA63J-103X	MG RESISTOR	10kΩ 1/16W J	
C1801	NCB30JK-105X	C CAPACITOR	1uF 6.3V K		R1407	NRSA63J-105X	MG RESISTOR	1MΩ 1/16W J	
C1802	NDC31HJ-271X	C CAPACITOR	270pF 50V J		R1408	NRSA63J-102X	MG RESISTOR	1kΩ 1/16W J	
C1803	NBE20JM-106X	TA E CAPACITOR	10uF 6.3V M		R1409	NRSA63J-102X	MG RESISTOR	1kΩ 1/16W J	
C1804	NCB31CK-104X	C CAPACITOR	0.1uF 16V K		R1410	NRSA63J-102X	MG RESISTOR	1kΩ 1/16W J	
C1805	NCB31CK-104X	C CAPACITOR	0.1uF 16V K		R1412	NRSA63J-102X	MG RESISTOR	1kΩ 1/16W J	
C1806	NBE20JM-106X	TA E CAPACITOR	10uF 6.3V M		R1413	NRSA63J-102X	MG RESISTOR	1kΩ 1/16W J	
C1807	NCB31CK-104X	C CAPACITOR	0.1uF 16V K		R1414	NRSA63J-102X	MG RESISTOR	1kΩ 1/16W J	
C1808	NDC31HJ-120X	C CAPACITOR	12pF 50V J		R1415	NRSA63J-102X	MG RESISTOR	1kΩ 1/16W J	
C1809	NDC31HJ-120X	C CAPACITOR	12pF 50V J		R1417	NRSA63J-102X	MG RESISTOR	1kΩ 1/16W J	
C1810	NCB31CK-104X	C CAPACITOR	0.1uF 16V K		R1419	NRSA63J-101X	MG RESISTOR	100Ω 1/16W J	
C1811	NCB31CK-104X	C CAPACITOR	0.1uF 16V K		R1420	NRSA63J-101X	MG RESISTOR	100Ω 1/16W J	
C1812	NCB31CK-104X	C CAPACITOR	0.1uF 16V K		R1427	NRSA63J-101X	MG RESISTOR	100Ω 1/16W J	
C1813	NCB31CK-104X	C CAPACITOR	0.1uF 16V K		R1428	NRSA63J-101X	MG RESISTOR	100Ω 1/16W J	
C1814	NCB31CK-104X	C CAPACITOR	0.1uF 16V K		R1429	NRSA63J-101X	MG RESISTOR	100Ω 1/16W J	
C1815	NCB31CK-104X	C CAPACITOR	0.1uF 16V K		R1430	NRSA63J-101X	MG RESISTOR	100Ω 1/16W J	
C1816	NCB31CK-104X	C CAPACITOR	0.1uF 16V K		R1431	NRSA63J-101X	MG RESISTOR	100Ω 1/16W J	
C1901	NBE20JM-226X	TA E CAPACITOR	22uF 6.3V M		R1434	NRSA63J-101X	MG RESISTOR	100Ω 1/16W J	
C1902	NCB31CK-104X	C CAPACITOR	0.1uF 16V K		R1435	NRSA63J-101X	MG RESISTOR	100Ω 1/16W J	
C1903	NCB31HK-103X	C CAPACITOR	0.01uF 50V K		R1436	NRSA63J-101X	MG RESISTOR	100Ω 1/16W J	
C1905	NCB31CK-104X	C CAPACITOR	0.1uF 16V K		R1437	NRSA63J-0R0X	MG RESISTOR	0Ω 1/16W J	
C1906	NCB31AK-105X	C CAPACITOR	1uF 10V K		R1438	NRSA63J-101X	MG RESISTOR	100Ω 1/16W J	
C1907	NCB31AK-105X	C CAPACITOR	1uF 10V K		R1439	NRSA63J-101X	MG RESISTOR	100Ω 1/16W J	
C1908	NCB31AK-105X	C CAPACITOR	1uF 10V K		R1440	NRSA63J-101X	MG RESISTOR	100Ω 1/16W J	
C1909	NCB31CK-104X	C CAPACITOR	0.1uF 16V K		R1441	NRSA63J-103X	MG RESISTOR	10kΩ 1/16W J	
C1910	NCB31CK-104X	C CAPACITOR	0.1uF 16V K		R1443	NRSA63J-103X	MG RESISTOR	10kΩ 1/16W J	
C1911	NCB31HK-152X	C CAPACITOR	1500pF 50V K		R1448	NRSA63J-272X	MG RESISTOR	2.7kΩ 1/16W J	
					R1453	NRSA63J-101X	MG RESISTOR	100Ω 1/16W J	
R1001	NRSA63D-301X	MG RESISTOR	300Ω 1/16W D		R1455	NRSA63J-101X	MG RESISTOR	100Ω 1/16W J	
R1003	NRSA63J-0R0X	MG RESISTOR	0Ω 1/16W J		R1456	NRSA63J-101X	MG RESISTOR	100Ω 1/16W J	
R1005	NRSA63J-103X	MG RESISTOR	10kΩ 1/16W J		R1457	NRSA63J-101X	MG RESISTOR	100Ω 1/16W J	
R1006	NRSA63J-0R0X	MG RESISTOR	0Ω 1/16W J		R1458	NRSA63J-101X	MG RESISTOR	100Ω 1/16W J	
R1007	NRSA63J-103X	MG RESISTOR	10kΩ 1/16W J		R1462	NRSA63J-102X	MG RESISTOR	1kΩ 1/16W J	
R1009	NRSA63J-103X	MG RESISTOR	10kΩ 1/16W J		R1463	NRSA63J-102X	MG RESISTOR	1kΩ 1/16W J	
R1016	NRSA63J-562X	MG RESISTOR	5.6kΩ 1/16W J		R1464	NRSA63J-102X	MG RESISTOR	1kΩ 1/16W J	
R1021	NRSA63D-332X	MG RESISTOR	3.3kΩ 1/16W D		R1465	NRSA63J-101X	MG RESISTOR	100Ω 1/16W J	
R1022	NRSA63D-152X	MG RESISTOR	1.5kΩ 1/16W D		R1467	NRSA63J-101X	MG RESISTOR	100Ω 1/16W J	
R1024	NRSA63D-272X	MG RESISTOR	2.7kΩ 1/16W D		R1469	NRSA63J-102X	MG RESISTOR	1kΩ 1/16W J	
R1027	NRSA63J-272X	MG RESISTOR	2.7kΩ 1/16W J		R1470	NRSA63J-0R0X	MG RESISTOR	0Ω 1/16W J	
R1028	NRSA63D-272X	MG RESISTOR	2.7kΩ 1/16W D		R1472	NRSA63J-222X	MG RESISTOR	2.2kΩ 1/16W J	
R1030	NRSA63J-103X	MG RESISTOR	10kΩ 1/16W J		R1473	NRSA63J-101X	MG RESISTOR	100Ω 1/16W J	
R1031	NRSA63J-103X	MG RESISTOR	10kΩ 1/16W J		R1474	NRSA63J-221X	MG RESISTOR	220Ω 1/16W J	
R1032	NRSA63J-103X	MG RESISTOR	10kΩ 1/16W J		R1475	NRSA63J-101X	MG RESISTOR	100Ω 1/16W J	
R1033	NRSA63J-471X	MG RESISTOR	470Ω 1/16W J		R1476	NRSA63J-271X	MG RESISTOR	270Ω 1/16W J	
R1036	NRSA63J-102X	MG RESISTOR	1kΩ 1/16W J		R1478	NRSA63J-101X	MG RESISTOR	100Ω 1/16W J	
R1037	NRSA63D-151X	MG RESISTOR	150Ω 1/16W D		R1479	NRSA63J-101X	MG RESISTOR	100Ω 1/16W J	
R1039	NRSA63J-102X	MG RESISTOR	1kΩ 1/16W J		R1480	NRSA63J-221X	MG RESISTOR	220Ω 1/16W J	
R1040	NRSA63D-101X	MG RESISTOR	100Ω 1/16W D		R1481	NRSA63J-121X	MG RESISTOR	120Ω 1/16W J	
R1042	NRSA63J-102X	MG RESISTOR	1kΩ 1/16W J		R1483	NRSA63J-101X	MG RESISTOR	100Ω 1/16W J	
R1043	NRSA63D-101X	MG RESISTOR	100Ω 1/16W D		R1491	NRSA63J-102X	MG RESISTOR	1kΩ 1/16W J	
R1046	NRSA63J-332X	MG RESISTOR	3.3kΩ 1/16W J		R1601	NRSA63J-220X	MG RESISTOR	22Ω 1/16W J	

△ Symbol No.	Part No.	Part Name	Description	Local	△ Symbol No.	Part No.	Part Name	Description	Local
R1602	NRSA63J-220X	MG RESISTOR	22Ω 1/16W J		R2211	NRSA63J-330X	MG RESISTOR	33Ω 1/16W J	
R1613	NRSA63J-220X	MG RESISTOR	22Ω 1/16W J		R2212	NRSA63J-330X	MG RESISTOR	33Ω 1/16W J	
R1614	NRSA63J-220X	MG RESISTOR	22Ω 1/16W J		R2213	NRSA63J-330X	MG RESISTOR	33Ω 1/16W J	
R1615	NRSA63J-220X	MG RESISTOR	22Ω 1/16W J		R2214	NRSA63J-330X	MG RESISTOR	33Ω 1/16W J	
R1616	NRSA63J-220X	MG RESISTOR	22Ω 1/16W J		R2215	NRSA63J-330X	MG RESISTOR	33Ω 1/16W J	
R1617	NRSA63J-101X	MG RESISTOR	100Ω 1/16W J		R2216	NRSA63J-221X	MG RESISTOR	220Ω 1/16W J	
R1618	NRSA63J-101X	MG RESISTOR	100Ω 1/16W J		RA1401	NRZ0087-101W	NET RESISTOR	100Ω 1/15W J	
R1619	NRSA63J-101X	MG RESISTOR	100Ω 1/16W J		RA1402	NRZ0087-101W	NET RESISTOR	100Ω 1/15W J	
R1620	NRSA63J-101X	MG RESISTOR	100Ω 1/16W J		RA1403	NRZ0087-101W	NET RESISTOR	100Ω 1/15W J	
R1621	NRSA63J-560X	MG RESISTOR	56Ω 1/16W J		RA1404	NRZ0087-101W	NET RESISTOR	100Ω 1/15W J	
R1622	NRSA63J-560X	MG RESISTOR	56Ω 1/16W J		RA1405	NRZ0087-101W	NET RESISTOR	100Ω 1/15W J	
R1623	NRSA63J-101X	MG RESISTOR	100Ω 1/16W J		RA1406	NRZ0087-101W	NET RESISTOR	100Ω 1/15W J	
R1624	NRSA63J-101X	MG RESISTOR	100Ω 1/16W J		RA1609	NRZ0087-220W	NET RESISTOR	22Ω 1/15W J	
R1625	NRSA63J-101X	MG RESISTOR	100Ω 1/16W J		RA1610	NRZ0087-220W	NET RESISTOR	22Ω 1/15W J	
R1626	NRSA63J-101X	MG RESISTOR	100Ω 1/16W J		RA1611	NRZ0087-220W	NET RESISTOR	22Ω 1/15W J	
R1627	NRSA63J-560X	MG RESISTOR	56Ω 1/16W J		RA1612	NRZ0087-220W	NET RESISTOR	22Ω 1/15W J	
R1628	NRSA63J-560X	MG RESISTOR	56Ω 1/16W J		RA1613	NRZ0087-220W	NET RESISTOR	22Ω 1/15W J	
R1629	NRSA63J-560X	MG RESISTOR	56Ω 1/16W J		RA1614	NRZ0087-220W	NET RESISTOR	22Ω 1/15W J	
R1630	NRSA63J-560X	MG RESISTOR	56Ω 1/16W J		RA1615	NRZ0087-220W	NET RESISTOR	22Ω 1/15W J	
R1631	NRSA63J-560X	MG RESISTOR	56Ω 1/16W J		RA1616	NRZ0087-220W	NET RESISTOR	22Ω 1/15W J	
R1632	NRSA63J-560X	MG RESISTOR	56Ω 1/16W J		RA1617	NRZ0087-101W	NET RESISTOR	100Ω 1/15W J	
R1653	NRSA63J-220X	MG RESISTOR	22Ω 1/16W J		RA1618	NRZ0087-101W	NET RESISTOR	100Ω 1/15W J	
R1654	NRSA63J-220X	MG RESISTOR	22Ω 1/16W J		RA1619	NRZ0087-101W	NET RESISTOR	100Ω 1/15W J	
R1655	NRSA63J-220X	MG RESISTOR	22Ω 1/16W J		RA1620	NRZ0087-101W	NET RESISTOR	100Ω 1/15W J	
R1656	NRSA63J-220X	MG RESISTOR	22Ω 1/16W J		RA1621	NRZ0087-101W	NET RESISTOR	100Ω 1/15W J	
R1657	NRSA63J-220X	MG RESISTOR	22Ω 1/16W J		RA1622	NRZ0087-101W	NET RESISTOR	100Ω 1/15W J	
R1658	NRSA63J-220X	MG RESISTOR	22Ω 1/16W J		RA1623	NRZ0087-101W	NET RESISTOR	100Ω 1/15W J	
R1659	NRSA63J-220X	MG RESISTOR	22Ω 1/16W J		RA1624	NRZ0087-101W	NET RESISTOR	100Ω 1/15W J	
R1660	NRSA63J-220X	MG RESISTOR	22Ω 1/16W J		RA1625	NRZ0087-220W	NET RESISTOR	22Ω 1/15W J	
R1801	NRSA63J-101X	MG RESISTOR	100Ω 1/16W J		RA1626	NRZ0087-220W	NET RESISTOR	22Ω 1/15W J	
R1802	NRSA63J-101X	MG RESISTOR	100Ω 1/16W J		RA1627	NRZ0087-220W	NET RESISTOR	22Ω 1/15W J	
R1803	NRSA63J-103X	MG RESISTOR	10kΩ 1/16W J		RA1628	NRZ0087-220W	NET RESISTOR	22Ω 1/15W J	
R1804	NRSA63J-103X	MG RESISTOR	10kΩ 1/16W J		RA1629	NRZ0087-101W	NET RESISTOR	100Ω 1/15W J	
R1807	NRSA63J-103X	MG RESISTOR	10kΩ 1/16W J		RA1630	NRZ0087-101W	NET RESISTOR	100Ω 1/15W J	
R1809	NRSA63J-103X	MG RESISTOR	10kΩ 1/16W J		RA1631	NRZ0087-101W	NET RESISTOR	100Ω 1/15W J	
R1810	NRSA63J-394X	MG RESISTOR	390kΩ 1/16W J		RA1632	NRZ0087-101W	NET RESISTOR	100Ω 1/15W J	
R1813	NRSA63J-560X	MG RESISTOR	56Ω 1/16W J		RA1633	NRZ0087-220W	NET RESISTOR	22Ω 1/15W J	
R1814	NRSA63J-560X	MG RESISTOR	56Ω 1/16W J		RA1634	NRZ0087-101W	NET RESISTOR	100Ω 1/15W J	
R1815	NRSA63J-560X	MG RESISTOR	56Ω 1/16W J		RA1801	NRZ0087-103W	NET RESISTOR	10kΩ 1/16W J	
R1816	NRSA63J-560X	MG RESISTOR	56Ω 1/16W J		RA1802	NRZ0087-103W	NET RESISTOR	10kΩ 1/16W J	
R1817	NRSA63J-512X	MG RESISTOR	5.1kΩ 1/16W J		RA2101	NRZ0087-330W	NET RESISTOR	33Ω 1/16W J	
R1818	NRSA63D-562X	MG RESISTOR	5.6kΩ 1/16W D		RA2102	NRZ0087-330W	NET RESISTOR	33Ω 1/16W J	
R1819	NRSA63D-751X	MG RESISTOR	750Ω 1/16W D		RA2103	NRZ0087-330W	NET RESISTOR	33Ω 1/16W J	
R1820	NRSA63J-103X	MG RESISTOR	10kΩ 1/16W J		RA2104	NRZ0087-330W	NET RESISTOR	33Ω 1/16W J	
R1821	NRSA63J-102X	MG RESISTOR	1kΩ 1/16W J		RA2208	NRZ0087-330W	NET RESISTOR	33Ω 1/16W J	
R1901	NRSA63J-104X	MG RESISTOR	100kΩ 1/16W J		RA2209	NRZ0087-330W	NET RESISTOR	33Ω 1/16W J	
R1902	NRSA63J-103X	MG RESISTOR	10kΩ 1/16W J		RA2210	NRZ0087-330W	NET RESISTOR	33Ω 1/16W J	
R1903	NRSA63J-222X	MG RESISTOR	2.2kΩ 1/16W J		RA2211	NRZ0087-330W	NET RESISTOR	33Ω 1/16W J	
R1904	NRSA63J-222X	MG RESISTOR	2.2kΩ 1/16W J		T1801	NQR0568-005X	CHOKE COIL		
R1907	NRSA63J-103X	MG RESISTOR	10kΩ 1/16W J		B1202	NRSA63J-0R0X	MG RESISTOR	0Ω 1/16W J	
R1912	NRSA63J-561X	MG RESISTOR	560Ω 1/16W J		B1208	NRSA63J-0R0X	MG RESISTOR	0Ω 1/16W J	
R1913	NRSA63J-121X	MG RESISTOR	120Ω 1/16W J		B1405	NRSA02J-0R0X	MG RESISTOR	0Ω 1/10W J	
R2101	NRSA63J-472X	MG RESISTOR	4.7kΩ 1/16W J		B1701	NRSA63J-0R0X	MG RESISTOR	0Ω 1/16W J	
R2102	NRSA63J-103X	MG RESISTOR	10kΩ 1/16W J		B1901	NRSA63J-0R0X	MG RESISTOR	0Ω 1/16W J	
R2103	NRSA63J-562X	MG RESISTOR	5.6kΩ 1/16W J		CN1101	QGB1231L2-15W	CONNECTOR	B-B (1-15)	
R2104	NRSA63J-330X	MG RESISTOR	33Ω 1/16W J		CN1102	QGB1231L2-15W	CONNECTOR	B-B (1-15)	
R2105	NRSA63J-820X	MG RESISTOR	82Ω 1/16W J		CN1103	QGF1016C6-19W	CONNECTOR	FFC/FPC (1-19)	
R2106	NRSA63J-220X	MG RESISTOR	22Ω 1/16W J		CN1403	QGF1016C6-04W	CONNECTOR	FFC/FPC (1-4)	
R2107	NRSA63J-220X	MG RESISTOR	22Ω 1/16W J		CN1801	QGB1231L2-09W	CONNECTOR	B-B (1-9)	
R2108	NRSA63J-820X	MG RESISTOR	82Ω 1/16W J		CN2101	QGF0508C2-40W	CONNECTOR	FFC/FPC (1-40)	
R2109	NRSA63J-220X	MG RESISTOR	22Ω 1/16W J		CN2201	QGF0508C2-40W	CONNECTOR	FFC/FPC (1-40)	
R2110	NRSA63J-820X	MG RESISTOR	82Ω 1/16W J		K1001	NQR0022-002X	FERRITE BEADS		
R2111	NRSA63J-330X	MG RESISTOR	33Ω 1/16W J		K1002	NQR0022-002X	FERRITE BEADS		
R2112	NRSA63J-330X	MG RESISTOR	33Ω 1/16W J		K1003	NQR0022-002X	FERRITE BEADS		
R2113	NRSA63J-330X	MG RESISTOR	33Ω 1/16W J		K1004	NQR0022-002X	FERRITE BEADS		
R2114	NRSA63J-330X	MG RESISTOR	33Ω 1/16W J		K1005	NQR0022-002X	FERRITE BEADS		
R2115	NRSA63J-330X	MG RESISTOR	33Ω 1/16W J		K1006	NQR0022-002X	FERRITE BEADS		
R2116	NRSA63J-221X	MG RESISTOR	220Ω 1/16W J		K1007	NQR0022-002X	FERRITE BEADS		
R2201	NRSA63J-103X	MG RESISTOR	10kΩ 1/16W J		K1008	NQR0022-002X	FERRITE BEADS		
R2202	NRSA63J-562X	MG RESISTOR	5.6kΩ 1/16W J		K1009	NQR0022-002X	FERRITE BEADS		
R2203	NRSA63J-472X	MG RESISTOR	4.7kΩ 1/16W J		K1010	NQR0022-002X	FERRITE BEADS		
R2204	NRSA63J-330X	MG RESISTOR	33Ω 1/16W J		K1011	NQR0022-002X	FERRITE BEADS		
R2205	NRSA63J-820X	MG RESISTOR	82Ω 1/16W J		K1012	NQR0022-002X	FERRITE BEADS		
R2206	NRSA63J-220X	MG RESISTOR	22Ω 1/16W J		K1013	NQR0022-002X	FERRITE BEADS		
R2207	NRSA63J-220X	MG RESISTOR	22Ω 1/16W J		K1014	NQR0022-002X	FERRITE BEADS		
R2208	NRSA63J-820X	MG RESISTOR	82Ω 1/16W J		K1015	NQR0022-002X	FERRITE BEADS		
R2209	NRSA63J-220X	MG RESISTOR	22Ω 1/16W J						
R2210	NRSA63J-820X	MG RESISTOR	82Ω 1/16W J						

Symbol No.	Part No.	Part Name	Description	Local
K1016	NQR0022-002X	FERRITE BEADS		
K1019	NQR0022-005X	FERRITE BEADS		
K1020	NQR0022-005X	FERRITE BEADS		
K1021	NQR0022-002X	FERRITE BEADS		
K1022	NQR0022-005X	FERRITE BEADS		
K1023	NQR0022-002X	FERRITE BEADS		
K1024	NQR0022-002X	FERRITE BEADS		
K1025	NQR0022-002X	FERRITE BEADS		
K1026	NQR0022-002X	FERRITE BEADS		
K1027	NQR0022-002X	FERRITE BEADS		
K1029	NQR0022-002X	FERRITE BEADS		
K1030	NQR0022-002X	FERRITE BEADS		
K1404	NQR0564-001X	FERRITE BEADS		
K1406	NQR0564-001X	FERRITE BEADS		
K1701	NRSA02J-0R0X	MG RESISTOR	0Ω 1/10W J	
K1702	NRSA02J-0R0X	MG RESISTOR	0Ω 1/10W J	
K1801	NQR0564-001X	FERRITE BEADS		
K1803	NQR0564-001X	FERRITE BEADS		
K2101	NQR0022-002X	FERRITE BEADS		
K2102	NQR0022-002X	FERRITE BEADS		
K2103	NQR0022-002X	FERRITE BEADS		
K2104	NQR0022-002X	FERRITE BEADS		
K2105	NQR0022-002X	FERRITE BEADS		
K2106	NQR0022-002X	FERRITE BEADS		
K2107	NQR0022-002X	FERRITE BEADS		
K2108	NQR0022-002X	FERRITE BEADS		
K2109	NQR0022-002X	FERRITE BEADS		
K2110	NQR0022-002X	FERRITE BEADS		
K2111	NQR0022-002X	FERRITE BEADS		
K2112	NQR0022-002X	FERRITE BEADS		
K2113	NQR0022-002X	FERRITE BEADS		
K2114	NQR0022-002X	FERRITE BEADS		
K2115	NQR0022-002X	FERRITE BEADS		
K2116	NQR0022-002X	FERRITE BEADS		
K2117	NQR0022-002X	FERRITE BEADS		
K2118	NQR0022-002X	FERRITE BEADS		
K2119	NQR0022-002X	FERRITE BEADS		
K2120	NQR0022-002X	FERRITE BEADS		
K2121	NQR0022-002X	FERRITE BEADS		
K2201	NQR0022-002X	FERRITE BEADS		
K2202	NQR0022-002X	FERRITE BEADS		
K2203	NQR0022-002X	FERRITE BEADS		
K2204	NQR0022-002X	FERRITE BEADS		
K2205	NQR0022-002X	FERRITE BEADS		
K2206	NQR0022-002X	FERRITE BEADS		
K2207	NQR0022-002X	FERRITE BEADS		
K2208	NQR0022-002X	FERRITE BEADS		
K2209	NQR0022-002X	FERRITE BEADS		
K2210	NQR0022-002X	FERRITE BEADS		
K2211	NQR0022-002X	FERRITE BEADS		
K2212	NQR0022-002X	FERRITE BEADS		
K2213	NQR0022-002X	FERRITE BEADS		
K2214	NQR0022-002X	FERRITE BEADS		
K2215	NQR0022-002X	FERRITE BEADS		
K2216	NQR0022-002X	FERRITE BEADS		
K2217	NQR0022-002X	FERRITE BEADS		
K2218	NQR0022-002X	FERRITE BEADS		
K2219	NQR0022-002X	FERRITE BEADS		
K2220	NQR0022-002X	FERRITE BEADS		
K2221	NQR0022-002X	FERRITE BEADS		
LC1401	NQR0512-008X	EMI FILTER		
LC1402	NQR0512-008X	EMI FILTER		
LC1403	NQR0512-008X	EMI FILTER		
X1301	NAX0733-001X	CRYSTAL	14.31818MHz	
X1402	NAX0768-001X	CRYSTAL	13.5MHz	
X1801	NAX0666-001X	CRYSTAL	24.576000MHz	

## Loading Motor board

Block No. [5][5]

Symbol No.	Part No.	Part Name	Description	Local
PW1	LPA10158-01A2	LOADING MOTOR BOARD ASSY		

## RGB\_YC Converter board

Block No. [6][8]

Symbol No.	Part No.	Part Name	Description	Local
PW1	LPA10291-01B	RGB_YC CONVERTER BOARD ASSY		
IC4401	BH7236AF-X	IC		
IC4402	MM1503XN-X	IC		
IC4403	74HC4538D-X	IC		
IC4404	BA7666FS-X	IC		
D4401	RB717F-X	SB DIODE		
C4401	QEKJ0JM-476Z	E CAPACITOR	47uF 6.3V M	
C4403	NCB31CK-104X	C CAPACITOR	0.1uF 16V K	
C4404	NCB30JK-105X	C CAPACITOR	1uF 6.3V K	
C4405	NCB30JK-105X	C CAPACITOR	1uF 6.3V K	
C4406	NCB30JK-105X	C CAPACITOR	1uF 6.3V K	
C4407	NCB31CK-104X	C CAPACITOR	0.1uF 16V K	
C4408	NRSA63J-0R0X	MG RESISTOR	0Ω 1/16W J	
C4409	NCB31EK-103X	C CAPACITOR	0.01uF 25V K	
C4410	QEKJ0JM-107Z	E CAPACITOR	100uF 6.3V M	
C4411	NCB31CK-104X	C CAPACITOR	0.1uF 16V K	
C4412	NCB30JK-105X	C CAPACITOR	1uF 6.3V K	
C4413	NCB30JK-105X	C CAPACITOR	1uF 6.3V K	
C4417	NCB31CK-104X	C CAPACITOR	0.1uF 16V K	
C4418	NDC21HJ-103X	C CAPACITOR	0.01uF 50V J	
C4419	NDC31HJ-102X	C CAPACITOR	1000pF 50V J	
C4420	QEKJ0JM-107Z	E CAPACITOR	100uF 6.3V M	
C4421	NCB31CK-104X	C CAPACITOR	0.1uF 16V K	
C4422	NCB30JK-105X	C CAPACITOR	1uF 6.3V K	
C4423	NCB30JK-105X	C CAPACITOR	1uF 6.3V K	
C4424	NCB30JK-105X	C CAPACITOR	1uF 6.3V K	
R4401	NRSA63J-0R0X	MG RESISTOR	0Ω 1/16W J	
R4402	NRSA63J-271X	MG RESISTOR	270Ω 1/16W J	
R4403	NRSA63J-221X	MG RESISTOR	220Ω 1/16W J	
R4404	NRSA63J-221X	MG RESISTOR	220Ω 1/16W J	
R4405	NRSA63J-221X	MG RESISTOR	220Ω 1/16W J	
R4411	NRSA63D-204X	MG RESISTOR	200kΩ 1/16W D	
R4412	NRSA63J-472X	MG RESISTOR	4.7kΩ 1/16W J	
R4413	NRSA63D-753X	MG RESISTOR	75kΩ 1/16W D	
R4414	NRSA63J-225X	MG RESISTOR	2.2MΩ 1/16W J	
R4415	NRSA63J-470X	MG RESISTOR	47Ω 1/16W J	
R4416	NRSA63J-470X	MG RESISTOR	47Ω 1/16W J	
R4417	NRSA63J-470X	MG RESISTOR	47Ω 1/16W J	
R4418	NRSA63J-101X	MG RESISTOR	100Ω 1/16W J	
R4419	NRSA63J-101X	MG RESISTOR	100Ω 1/16W J	
R4420	NRSA63J-101X	MG RESISTOR	100Ω 1/16W J	
CN4402	QGG2502K1-12	CONNECTOR	(1-12)	
OT1	LP40425-001A	BRACKET(PWB)		

## Secam board

Block No. [8][8]

Symbol No.	Part No.	Part Name	Description	Local
PW1	LPA10011-03A	SECAM BOARD ASSY		EF
IC301	LA7358-E	IC		EF
Q301	2SB1218A/QR-X	TRANSISTOR		EF
Q301	or 2SA1576A/QR-X	TRANSISTOR		EF
Q301	or 2PA1576R-X	TRANSISTOR		EF
Q302	UN511E-X	DIGI TRANSISTOR		EF
Q302	or DTA144WUA-X	DIGI TRANSISTOR		EF
Q302	or PDTA144WU-X	DIGI TRANSISTOR		EF
C301	NDC21HJ-151X	C CAPACITOR	150pF 50V J	EF
C302	QEK1HM-225Z	E CAPACITOR	2.2uF 50V M	EF
C303	NCB21HK-682X	C CAPACITOR	6800pF 50V K	EF

△ Symbol No.	Part No.	Part Name	Description	Local	△ Symbol No.	Part No.	Part Name	Description	Local
C304	NCB21HK-682X	C CAPACITOR	6800pF 50V K	EF	Q5502	or RT1P141C-X	DIGI TRANSISTOR		
C305	NCB21HK-103X	C CAPACITOR	0.01uF 50V K	EF	Q5503	UN2211-X	TRANSISTOR		
C307	NDC21HJ-151X	C CAPACITOR	150pF 50V J	EF	Q5503	or DTC114EKA-X	DIGI TRANSISTOR		
C308	NCB21HK-103X	C CAPACITOR	0.01uF 50V K	EF	Q5503	or RT1N141C-X	DIGI TRANSISTOR		
C309	NCB21EK-104X	C CAPACITOR	0.1uF 25V K	EF	Q5504	2SC3576-JVC-T	TRANSISTOR		
C310	NCB21HK-103X	C CAPACITOR	0.01uF 50V K	EF	Q5504	or 2SD2144S/VW/-T	TRANSISTOR		
C311	NCB21HK-103X	C CAPACITOR	0.01uF 50V K	EF	Q5505	UN2113-X	TRANSISTOR		
C312	NCB21HK-102X	C CAPACITOR	1000pF 50V K	EF	Q5505	or DTA144EKA-X	DIGI TRANSISTOR		
C313	QEK1HM-474Z	E CAPACITOR	0.47uF 50V M	EF	Q5505	or RT1P441C-X	DIGI TRANSISTOR		
C314	NDC21HJ-471X	C CAPACITOR	470pF 50V J	EF	Q5508	2SA1585S/QR/-T	TRANSISTOR		
C315	QEK1EM-106Z	E CAPACITOR	10uF 25V M	EF	Q5509	UN2211-X	TRANSISTOR		
C316	NCB21HK-103X	C CAPACITOR	0.01uF 50V K	EF	Q5509	or DTC114EKA-X	DIGI TRANSISTOR		
C317	NCB21HK-681X	C CAPACITOR	680pF 50V K	EF	Q5509	or RT1N141C-X	DIGI TRANSISTOR		
C318	NCB21EK-223X	C CAPACITOR	0.022uF 25V K	EF	Q7151	UN221E-X	TRANSISTOR		
C319	QEK1HM-105Z	E CAPACITOR	1uF 50V M	EF	Q7151	or DTC144WKA-X	DIGI TRANSISTOR		
C320	QDYB1CM-103Y	C CAPACITOR	0.01uF 16V M	EF	Q7151	or RT1N44HC-X	DIGI TRANSISTOR		
C321	NDC21HG-301X	C CAPACITOR	300pF 50V G	EF	Q8001	2SC2412K/QRS/-X	TRANSISTOR		
C322	NCB21CK-474X	C CAPACITOR	0.47uF 16V K	EF	Q8001	or 2SD601A/QRS/-X	TRANSISTOR		
C323	QEK0JM-476Z	E CAPACITOR	47uF 6.3V M	EF	Q8001	or 2SC3928A/QRS/-X	TRANSISTOR		
					Q8002	2SC2412K/QRS/-X	TRANSISTOR		
R301	NRSA02J-273X	MG RESISTOR	27kΩ 1/10W J	EF	Q8002	or 2SD601A/QRS/-X	TRANSISTOR		
R302	NRSA02J-124X	MG RESISTOR	120kΩ 1/10W J	EF	Q8002	or 2SC3928A/QRS/-X	TRANSISTOR		
R303	NRSA02J-273X	MG RESISTOR	27kΩ 1/10W J	EF	Q8003	DTC144WKA-X	DIGI TRANSISTOR		
R304	NRSA02J-682X	MG RESISTOR	6.8kΩ 1/10W J	EF	Q8003	or UN221E-X	TRANSISTOR		
R305	NRSA02J-473X	MG RESISTOR	47kΩ 1/10W J	EF	Q8003	or RT1N44HC-X	DIGI TRANSISTOR		
R306	NRSA02J-273X	MG RESISTOR	27kΩ 1/10W J	EF	Q8004	DTC144WKA-X	DIGI TRANSISTOR		
R307	NRSA02J-222X	MG RESISTOR	2.2kΩ 1/10W J	EF	Q8004	or UN221E-X	TRANSISTOR		
R308	NRSA02J-222X	MG RESISTOR	2.2kΩ 1/10W J	EF	Q8004	or RT1N44HC-X	DIGI TRANSISTOR		
R309	NRSA02J-821X	MG RESISTOR	820Ω 1/10W J	EF	Q8005	DTA144WKA-X	TRANSISTOR		
R310	NRSA02J-223X	MG RESISTOR	22kΩ 1/10W J	EF	Q8005	or UN211E-X	DIGI TRANSISTOR		
R311	NRSA02J-392X	MG RESISTOR	3.9kΩ 1/10W J	EF	Q8005	or RT1P44HC-X	DIGI TRANSISTOR		
R312	NRSA02J-272X	MG RESISTOR	2.7kΩ 1/10W J	EF	D5501	MTZJ7.5B-T2	Z DIODE		
R313	NRSA02J-223X	MG RESISTOR	22kΩ 1/10W J	EF	D5503	MTZJ27D-T2	Z DIODE		
R314	QRE141J-243Y	C RESISTOR	24kΩ 1/4W J	EF	D5510	1S4-T2	SB DIODE		
R315	QRE141J-564Y	C RESISTOR	560kΩ 1/4W J	EF	D5513	1A3G-T2	SI DIODE		
R316	QRE141J-224Y	C RESISTOR	220kΩ 1/4W J	EF	D5513	or 10EDB20-T2	SI DIODE		
R329	NRSA02J-0R0X	MG RESISTOR	0Ω 1/10W J	EF	D5513	or 1G3-T2	SI DIODE		
L301	QQL29BJ-100Z	P COIL	10uH J	EF	D5514	MTZJ22D-T2	Z DIODE		
L302	QQL29BJ-6R8Z	P COIL	6.8uH J	EF	D8001	1SS133-T2	SI DIODE		
L303	QQL071J-270Y	COIL	27uH J	EF	D8001	or 1SS270A-T2	SI DIODE		
CN301	QGG2502K1-11	CONNECTOR	(1-11)	EF	C5504	NCF31AZ-105X	C CAPACITOR	1uF 10V Z	
W311	NRSA02J-0R0X	MG RESISTOR	0Ω 1/10W J	EF	C5505	NCF31AZ-105X	C CAPACITOR	1uF 10V Z	
W312	NRSA02J-0R0X	MG RESISTOR	0Ω 1/10W J	EF	C5506	NCB30JK-105X	C CAPACITOR	1uF 6.3V K	
W314	NRSA02J-0R0X	MG RESISTOR	0Ω 1/10W J	EF	C5507	NCB30JK-105X	C CAPACITOR	1uF 6.3V K	
W315	NRSA02J-0R0X	MG RESISTOR	0Ω 1/10W J	EF	C5508	NCF31AZ-105X	C CAPACITOR	1uF 10V Z	
OT1	LP40425-001A	BRACKET(PWB)		EF	C5509	NCB30JK-105X	C CAPACITOR	1uF 6.3V K	
					C5510	NCB31HK-103X	C CAPACITOR	0.01uF 50V K	
					C5511	QEZ0654-477Z	E CAPACITOR	470uF 10V M	
					C5515	QETN1AM-227Z	E CAPACITOR	220uF 10V M	
					C5520	NCB30JK-105X	C CAPACITOR	1uF 6.3V K	
					C5522	NCB30JK-105X	C CAPACITOR	1uF 6.3V K	
					C5524	NCB11AK-106X	C CAPACITOR	10uF 10V K	
					C5526	NCB31HK-103X	C CAPACITOR	0.01uF 50V K	
					C5533	QETN1CM-477Z	E CAPACITOR	470uF 16V M	
					C8001	NDC31HJ-101X	C CAPACITOR	100pF 50V J	
					C8003	NDC31HJ-101X	C CAPACITOR	100pF 50V J	
					C8005	NDC31HJ-101X	C CAPACITOR	100pF 50V J	
					C8007	NDC31HJ-101X	C CAPACITOR	100pF 50V J	
					C8009	QEK1EM-106Z	E CAPACITOR	10uF 25V M	
					C8010	QEK1EM-106Z	E CAPACITOR	10uF 25V M	
					C8011	QEK1HM-475Z	E CAPACITOR	4.7uF 50V M	
					C8012	NCB31HK-104X	C CAPACITOR	0.1uF 50V K	
					C8013	QEK0JM-107Z	E CAPACITOR	100uF 6.3V M	
					C8014	NCB31HK-104X	C CAPACITOR	0.1uF 50V K	
					C8015	QEK0JM-107Z	E CAPACITOR	100uF 6.3V M	
					C8016	NCB31HK-104X	C CAPACITOR	0.1uF 50V K	
					C8051	QEK0JM-337Z	E CAPACITOR	330uF 6.3V M	
					C8052	QEK1CM-107Z	E CAPACITOR	100uF 16V M	
					C8053	NCB31HK-104X	C CAPACITOR	0.1uF 50V K	
					C8054	QEK0JM-337Z	E CAPACITOR	330uF 6.3V M	
					C8055	NCB31HK-104X	C CAPACITOR	0.1uF 50V K	
					C8056	QEK1CM-107Z	E CAPACITOR	100uF 16V M	
					C8057	QEK1CM-107Z	E CAPACITOR	100uF 16V M	
					C8201	QEK1CM-476Z	E CAPACITOR	47uF 16V M	
					C8202	NCB31HK-471X	C CAPACITOR	470pF 50V K	
					C8203	NCB31HK-471X	C CAPACITOR	470pF 50V K	

## Junction board

Block No. [9][2]

△ Symbol No.	Part No.	Part Name	Description	Local
PW1	LPA10298-03B2	JUNCTION BOARD ASSY		
IC5502	MM1689BH-X	IC		
IC5503	MM1665AH-X	IC		
IC8001	RC4558D-X	IC		
IC8001	or BA15218F-XE	IC		
IC8002	AK5357ET-X	IC		
IC8002	or AK5357VT-X	IC		
IC8201	RC4558D-X	IC		
IC8201	or BA15218F-XE	IC		
IC8202	AK4385ET-X	IC		
IC8202	or AK4385VT-X	IC		
Q5501	2SD601A/QRS/-X	TRANSISTOR		
Q5501	or 2SC2412K/QRS/-X	TRANSISTOR		
Q5501	or 2SC3928A/QRS/-X	TRANSISTOR		
Q5502	UN2111-X	TRANSISTOR		
Q5502	or DTA114EKA-X	DIGI TRANSISTOR		

△ Symbol No.	Part No.	Part Name	Description	Local	△ Symbol No.	Part No.	Part Name	Description	Local
C8204	NCB31HK-472X	C CAPACITOR	4700pF 50V K		L8001	QLL29BJ-220Z	P COIL	22uH J	
C8205	NCB31HK-471X	C CAPACITOR	470pF 50V K		L8002	QLL29BJ-220Z	P COIL	22uH J	
C8206	NCB31HK-472X	C CAPACITOR	4700pF 50V K						
C8207	NCB31HK-471X	C CAPACITOR	470pF 50V K		B5504	NRSA63J-0R0X	MG RESISTOR	0Ω 1/16W J	
C8208	QEK1CM-476Z	E CAPACITOR	47uF 16V M		B7111	NRSA63J-0R0X	MG RESISTOR	0Ω 1/16W J	
C8209	NCB31HK-104X	C CAPACITOR	0.1uF 50V K		CN5501	QGF1208C1-19	CONNECTOR	FROM REG	
C8210	QEK0JM-337Z	E CAPACITOR	330uF 6.3V M		CN5504	QGA2501C1-04	CONNECTOR	TO HDD	
C8231	QEK0JM-107Z	E CAPACITOR	100uF 6.3V M		CN7102	QGB1231M1-19	CONNECTOR	SYS 1-19	
C8232	NCB31HK-104X	C CAPACITOR	0.1uF 50V K		CN7104	QGF1207C1-04	CONNECTOR	VIDEO SW	
					CN7107	QGF1207C1-13	CONNECTOR	V-OUT 7-19	
R5501	QRE121J-471Y	C RESISTOR	470Ω 1/2W J		CN7108	QGB1231M1-15	CONNECTOR	DIGITAL	
R5502	QRE121J-471Y	C RESISTOR	470Ω 1/2W J		CN7109	QGB1231M1-15	CONNECTOR	DIGITAL	
R5503	NRSA63J-562X	MG RESISTOR	5.6kΩ 1/16W J		CN7110	QGF1040C1-19	CONNECTOR	DIGITAL	EF
R5504	NRSA63J-472X	MG RESISTOR	4.7kΩ 1/16W J		CN7125	QGF1207C1-04	CONNECTOR	JIG	
R5505	NRSA63J-103X	MG RESISTOR	10kΩ 1/16W J		CN8001	QGB1231M1-11	CONNECTOR	AUDIO	
R5507	NRSA63F-683X	MG RESISTOR	68kΩ 1/16W F		△ CP5501	QMFZ053-2R0Z-J1	FUSE	2A	
R5508	NRSA63F-393X	MG RESISTOR	39kΩ 1/16W F		ET1	QNZ0136-001Z	EARTH PLATE		
R5509	NRSA63F-393X	MG RESISTOR	39kΩ 1/16W F		ET2	QNZ0136-001Z	EARTH PLATE		
R5510	NRSA63F-333X	MG RESISTOR	33kΩ 1/16W F		K7101	NRSA63J-0R0X	MG RESISTOR	0Ω 1/16W J	
R5511	NRSA63J-103X	MG RESISTOR	10kΩ 1/16W J		K8001	NRSA63J-0R0X	MG RESISTOR	0Ω 1/16W J	
R5512	QRE141J-821Y	C RESISTOR	820Ω 1/4W J		K8002	NRSA63J-0R0X	MG RESISTOR	0Ω 1/16W J	
R5513	QRE141J-821Y	C RESISTOR	820Ω 1/4W J		K8201	NRSA63J-0R0X	MG RESISTOR	0Ω 1/16W J	
△ R5516	QRZ9051-680X	FUSI RESISTOR	68Ω 0.25W J		K8202	NRSA63J-4R7X	MG RESISTOR	4.7Ω 1/16W J	
R7147	NRSA63J-0R0X	MG RESISTOR	0Ω 1/16W J		W1	NRSA63J-0R0X	MG RESISTOR	0Ω 1/16W J	
R7148	NRSA63J-0R0X	MG RESISTOR	0Ω 1/16W J		W2	NRSA63J-0R0X	MG RESISTOR	0Ω 1/16W J	
R7149	NRSA63J-0R0X	MG RESISTOR	0Ω 1/16W J		W3	NRSA63J-0R0X	MG RESISTOR	0Ω 1/16W J	
R7150	NRSA63J-0R0X	MG RESISTOR	0Ω 1/16W J		W4	NRSA63J-0R0X	MG RESISTOR	0Ω 1/16W J	
R7151	NRSA63J-200X	MG RESISTOR	20Ω 1/16W J		W5	NRSA63J-0R0X	MG RESISTOR	0Ω 1/16W J	
R7152	NRSA63J-103X	MG RESISTOR	10kΩ 1/16W J		W6	NRSA63J-0R0X	MG RESISTOR	0Ω 1/16W J	
R7161	NRSA63J-0R0X	MG RESISTOR	0Ω 1/16W J		W7	NRSA63J-0R0X	MG RESISTOR	0Ω 1/16W J	
R7162	NRSA63J-0R0X	MG RESISTOR	0Ω 1/16W J		W8	NRSA63J-0R0X	MG RESISTOR	0Ω 1/16W J	
R8001	NRSA63J-103X	MG RESISTOR	10kΩ 1/16W J						
R8002	NRSA63J-103X	MG RESISTOR	10kΩ 1/16W J						
R8003	NRSA63J-103X	MG RESISTOR	10kΩ 1/16W J						
R8004	NRSA63J-103X	MG RESISTOR	10kΩ 1/16W J						
R8005	NRSA63J-103X	MG RESISTOR	10kΩ 1/16W J						
R8006	NRSA63J-103X	MG RESISTOR	10kΩ 1/16W J						
R8007	NRSA63J-103X	MG RESISTOR	10kΩ 1/16W J						
R8008	NRSA63J-103X	MG RESISTOR	10kΩ 1/16W J						
R8009	NRSA63J-152X	MG RESISTOR	1.5kΩ 1/16W J						
R8010	NRSA63J-152X	MG RESISTOR	1.5kΩ 1/16W J						
R8011	NRSA63J-152X	MG RESISTOR	1.5kΩ 1/16W J						
R8012	NRSA63J-152X	MG RESISTOR	1.5kΩ 1/16W J						
R8013	NRSA63J-470X	MG RESISTOR	47Ω 1/16W J						
R8014	NRSA63J-470X	MG RESISTOR	47Ω 1/16W J						
R8015	NRSA63J-470X	MG RESISTOR	47Ω 1/16W J						
R8016	NRSA63J-470X	MG RESISTOR	47Ω 1/16W J						
R8017	NRSA63J-103X	MG RESISTOR	10kΩ 1/16W J						
R8018	NRSA63J-123X	MG RESISTOR	12kΩ 1/16W J						
R8019	NRSA63J-223X	MG RESISTOR	22kΩ 1/16W J						
R8021	NRSA63J-473X	MG RESISTOR	47kΩ 1/16W J						
R8051	NRSA63J-221X	MG RESISTOR	220Ω 1/16W J						
R8052	NRSA63J-0R0X	MG RESISTOR	0Ω 1/16W J						
R8201	NRSA63J-471X	MG RESISTOR	470Ω 1/16W J						
R8202	NRSA63J-273X	MG RESISTOR	27kΩ 1/16W J						
R8203	NRSA63D-512X	MG RESISTOR	5.1kΩ 1/16W D						
R8204	NRSA63J-121X	MG RESISTOR	120Ω 1/16W J						
R8205	NRSA63J-121X	MG RESISTOR	120Ω 1/16W J						
R8206	NRSA63D-512X	MG RESISTOR	5.1kΩ 1/16W D						
R8207	NRSA63D-512X	MG RESISTOR	5.1kΩ 1/16W D						
R8208	NRSA63J-121X	MG RESISTOR	120Ω 1/16W J						
R8209	NRSA63J-121X	MG RESISTOR	120Ω 1/16W J						
R8210	NRSA63D-512X	MG RESISTOR	5.1kΩ 1/16W D						
R8211	NRSA63J-273X	MG RESISTOR	27kΩ 1/16W J						
R8212	NRSA63J-471X	MG RESISTOR	470Ω 1/16W J						
R8213	NRSA63J-470X	MG RESISTOR	47Ω 1/16W J						
R8214	NRSA63J-470X	MG RESISTOR	47Ω 1/16W J						
R8215	NRSA63J-470X	MG RESISTOR	47Ω 1/16W J						
R8216	NRSA63J-470X	MG RESISTOR	47Ω 1/16W J						
R8217	NRSA63J-103X	MG RESISTOR	10kΩ 1/16W J						
R8219	NRSA63J-432X	MG RESISTOR	4.3kΩ 1/16W J						
R8220	NRSA63J-432X	MG RESISTOR	4.3kΩ 1/16W J						
R8221	NRSA63J-432X	MG RESISTOR	4.3kΩ 1/16W J						
R8222	NRSA63J-432X	MG RESISTOR	4.3kΩ 1/16W J						
R8231	NRSA63J-222X	MG RESISTOR	2.2kΩ 1/16W J						
R8232	NRSA63J-222X	MG RESISTOR	2.2kΩ 1/16W J						
R8233	NRSA63J-102X	MG RESISTOR	1kΩ 1/16W J						



# Packing materials and accessories parts list

Block No.M3MM

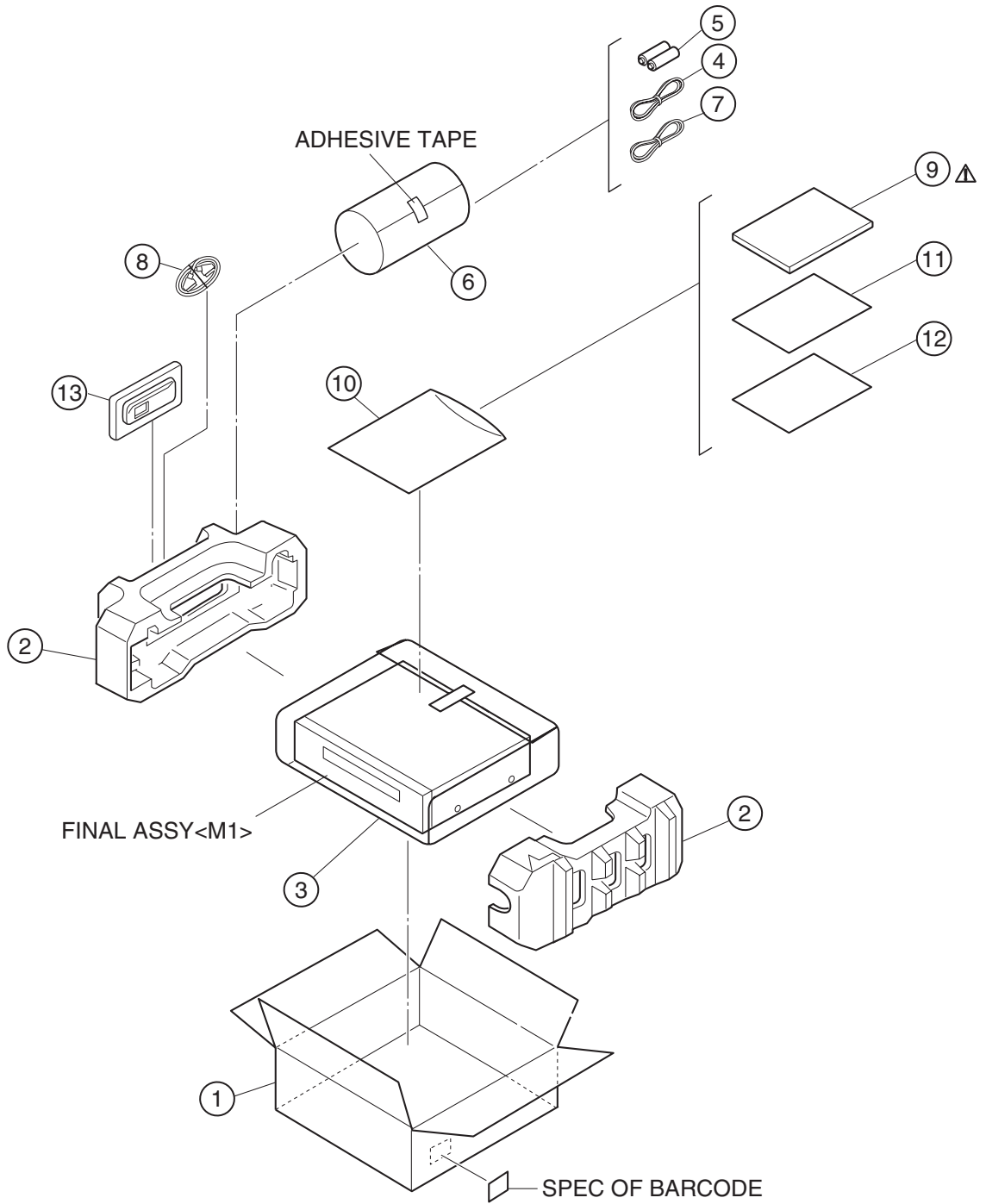

# Packing and accessories

Block No. [M][3][M][M]

△ Symbol No.	Part No.	Part Name	Description	Local
1	LP31540-009A	PACKING CASE		E
1	LP31540-011A	PACKING CASE		EF
1	LP31540-010A	PACKING CASE		EK
2	LP31555-001A	CUSHION ASSY		
3	PQM30021-105	POLY BAG		
4	QAM0525-002	RF CABLE		
5	-----	BATTERY	R6TYPE(x2)	
6	QPC02202230P	POLY BAG	22cm x 22cm	
7	QAL0805-001	LED CABLE ASSY		
8	QAM0502-002	PERI CABLE		
△ 9	LPT1072-001A	INST BOOK	(ENGLISH)	E
△ 9	LPT1072-002A	INST BOOK	(GERMANY)	E
△ 9	LPT1072-003A	INST BOOK	(FRENCH)	E
△ 9	LPT1072-004A	INST BOOK	(DUTCH)	E
△ 9	LPT1072-005A	INST BOOK	(SPANISH)	E
△ 9	LPT1072-006A	INST BOOK	(ITALIAN)	E
△ 9	LPT1072-007A	INST BOOK	(DANISH)	E
△ 9	LPT1072-008A	INST BOOK	(FINNISH)	E
△ 9	LPT1072-009A	INST BOOK	(SWEDISH)	E
△ 9	LPT1072-010A	INST BOOK	(NORWEGIAN)	E
△ 9	LPT1072-011A	INST BOOK	(PORTUGUESE)	E
△ 9	LPT1072-012A	INST BOOK	(CZECH)	E
△ 9	LPT1072-013A	INST BOOK	(POLISH)	E
△ 9	LPT1072-014A	INST BOOK	(HUNGARIAN)	E
△ 9	LPT1074-001A	INST BOOK	(FRENCH)	EF
△ 9	LPT1073-001A	INST BOOK	(ENGLISH)	EK
10	QPC02503530P	POLY BAG	INST	
11	LYT0194-001B	Q.CARD		EK
12	-----	WARRANTY CARD	BT-54027-1	
13	RM-SDR052E	REMOCON UNIT		